

COMPONENTS	IMPEDANCE
N MALE	50 OHM
N FEMALE BULKHEAD	50 OHM
PE-SR402AL	50 OHM

Standard Lengths	
-12	12"
-24	24"
-36	36"
-48	48"
-60	60"
-XXX	Custom Length in inches

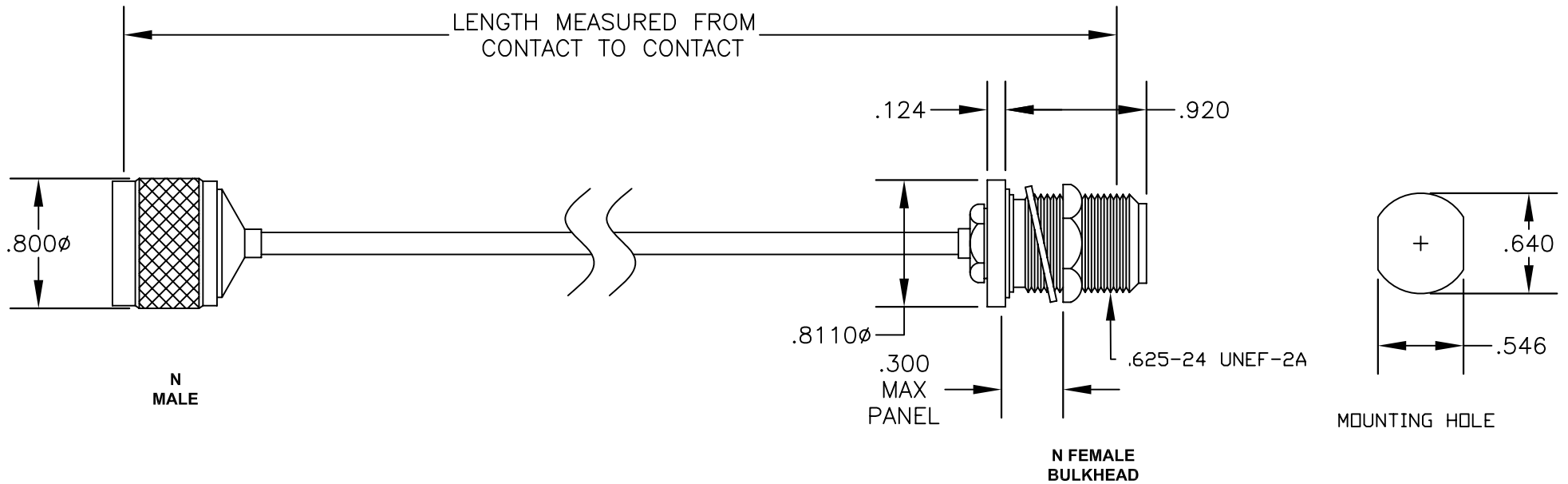

PASTERNAK ENTERPRISES, INC.

P.O BOX 16759, IRVINE, CA 92623
PHONE (949) 261-1920 FAX (949) 261-7451

WEB ADDRESS: www.pasternack.com
E-MAIL ADDRESS: sales@pasternack.com

COAXIAL & FIBER OPTICS

DWG TITLE

PE34158-XX

DES.

CABLE ASSEMBLY, PE-SR402AL, N MALE TO N FEMALE BULKHEAD

SIZE A

FSCM NO. 53919

CAD FILE 060407

SCALE N/A

127

NOTES:

- UNLESS OTHERWISE SPECIFIED ALL DIMENSIONS ARE NOMINAL.
- ALL SPECIFICATIONS ARE SUBJECT TO CHANGE WITHOUT NOTICE AT ANY TIME.
- DIMENSIONS ARE IN INCHES.
- LENGTH TOLERANCE IS $\pm 1.5\%$ OR $\pm 3/8"$, WHICHEVER IS GREATER.