



TNC Male to TNC Male Cable 36 Inch
Length Using PE-C195 Coax

RF Cable Assemblies Technical Data Sheet

PE36555-36

Configuration

- Connector 1: TNC Male
- Connector 2: TNC Male
- Cable Type: PE-C195

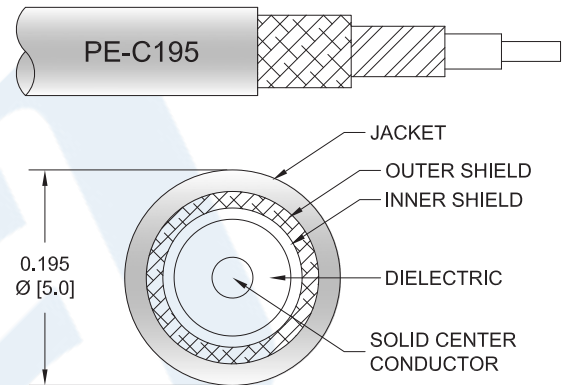

Electrical Specifications

Description	Minimum	Typical	Maximum	Units
Frequency Range	DC		5.8	GHz
VSWR			1.4:1	
Velocity of Propagation		80		%
RF Shielding	90			dB
Capacitance		25.4 [83.33]		pF/ft [pF/m]
Jacket Spark			5,000	Vrms

Specifications by Frequency

Description	F1	F2	F3	F4	F5	Units
Frequency	0.25	0.5	1	2.5	5.8	GHz
Insertion Loss (Typ.)	0.365	0.436	0.535	0.743	1.046	dB
VSWR (Max.)	1.4:1	1.4:1	1.4:1	1.4:1		
Return Loss (Max.)	15.56	15.563	15.563	15.563		dB

Mechanical Specifications

Cable Assembly

Length*	36 in [914.4 mm]
Diameter	0.591 in [15.01 mm]

Click the following link (or enter part number in "SEARCH" on website) to obtain additional part information including price, inventory and certifications: [TNC Male to TNC Male Cable 36 Inch Length Using PE-C195 Coax PE36555-36](#)



TNC Male to TNC Male Cable 36 Inch Length Using PE-C195 Coax

RF Cable Assemblies Technical Data Sheet

PE36555-36

Weight	0.12 lbs [54.43 g]
Cable	
Cable Type	PE-C195
Impedance	50 Ohms
Inner Conductor Type	Solid
Inner Conductor Material and Plating	Copper
Dielectric Type	PE (F)
Number of Shields	2
Shield Layer 1	Aluminum Tape
Shield Layer 2	Tinned Copper Braid
Jacket Material	PE, Black
Jacket Diameter	0.195 in [4.95 mm]
One Time Minimum Bend Radius	0.5 in [12.7 mm]
Repeated Minimum Bend Radius	2 in [50.8 mm]

Connectors

Description	Connector 1	Connector 2
Type	TNC Male	TNC Male
Specification	MIL-STD-348A	MIL-STD-348A
Impedance	50 Ohms	50 Ohms
Contact Material and Plating	Brass, Gold	Brass, Gold
Contact Plating Specification	30µ in. minimum	30µ in. minimum
Dielectric Type	Teflon	Teflon
Body Material and Plating	Brass, Nickel	Brass, Nickel
Body Plating Specification	100µ in. minimum	100µ in. minimum

Mechanical Specification Notes:

*All cable assemblies have a length tolerance of 1.5% or ± 3/8", whichever is greater.

Compliance Certifications (see [product page](#) for current document)

Plotted and Other Data

Notes:

- Values at 25°C, sea level.

Click the following link (or enter part number in "SEARCH" on website) to obtain additional part information including price, inventory and certifications: [TNC Male to TNC Male Cable 36 Inch Length Using PE-C195 Coax PE36555-36](#)



TNC Male to TNC Male Cable 36 Inch
Length Using PE-C195 Coax

RF Cable Assemblies Technical Data Sheet

PE36555-36

How to Order

Part Number Configuration:

PE36555

- **xx**

uu

Unit of Measure:
cm = Centimeters
<blank> = Inches
Length
Base Number

Example: PE36555-12 = 12 inches long cable
PE36555-100cm = 100 cm long cable

TNC Male to TNC Male Cable 36 Inch Length Using PE-C195 Coax from Pasternack Enterprises has same day shipment for domestic and International orders. Our RF, microwave and millimeter wave products maintain a 99.4% availability and are part of the broadest selection in the industry.

Click the following link (or enter part number in "SEARCH" on website) to obtain additional part information including price, inventory and certifications: [TNC Male to TNC Male Cable 36 Inch Length Using PE-C195 Coax PE36555-36](https://www.pasternack.com/tnc-male-tnc-male-pe-c195-cable-assembly-pe36555-36-p.aspx)

URL: <https://www.pasternack.com/tnc-male-tnc-male-pe-c195-cable-assembly-pe36555-36-p.aspx>

The information contained in this document is accurate to the best of our knowledge and representative of the part described herein. It may be necessary to make modifications to the part and/or the documentation of the part, in order to implement improvements. Pasternack reserves the right to make such changes as required. Unless otherwise stated, all specifications are nominal. Pasternack does not make any representation or warranty regarding the suitability of the part described herein for any particular purpose, and Pasternack does not assume any liability arising out of the use of any part or documentation.

PE36555-36 CAD Drawing

TNC Male to TNC Male Cable 36 Inch Length Using PE-C195 Coax

Standard Lengths	
-12	12"
-24	24"
-36	36"
-48	48"
-60	60"
-XXX	Custom Length in Inches

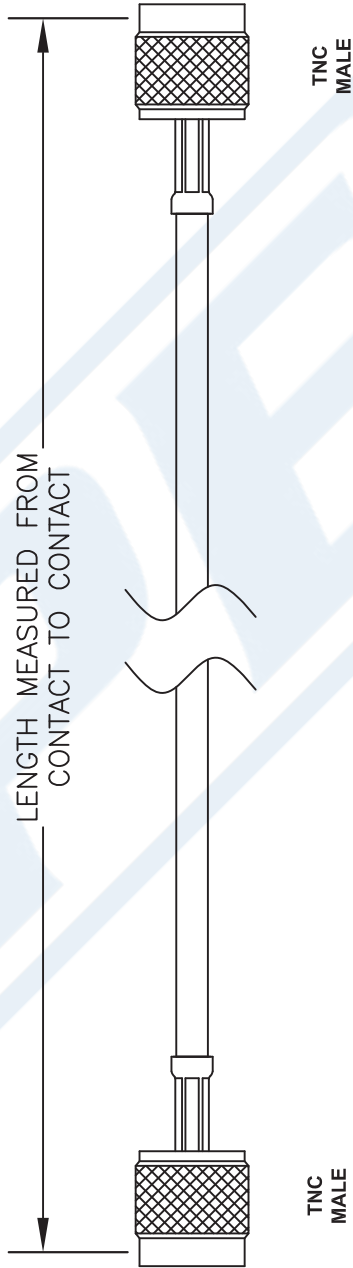

NOTES:
 1. UNLESS OTHERWISE SPECIFIED ALL DIMENSIONS ARE NOMINAL.
 2. ALL SPECIFICATIONS ARE SUBJECT TO CHANGE WITHOUT NOTICE AT ANY TIME.
 3. DIMENSIONS ARE IN INCHES (mm).
 4. LENGTH TOLERANCE IS $\pm 1.5\%$ OR $3/8"$, WHICHEVER IS GREATER.

DWG TITLE
PE36555-XX

PE PASTERNAK®
 Pasternack Enterprises, Inc.
 P.O. Box 16759 | Irvine | CA | 92623
Phone: (949) 261-1920 | **Fax:** (949) 261-7451
Website: www.pasternack.com | **E-Mail:** sales@pasternack.com

REV. A	FSCM NO. 53919	CAD FILE 082411	SCALE N/A	SIZE A	2231
--------	----------------	-----------------	-----------	--------	------