



75 Ohm BNC Male to 75 Ohm BNC Female Bulkhead Cable
12 Inch Length Using 75 Ohm PE-B159-BK Black Coax

RF Cable Assemblies Technical Data Sheet

PE38132/BK-12

Configuration

- Connector 1: BNC Male
- Connector 2: BNC Female Bulkhead
- Cable Type: MINI 59

Features

- Max Frequency 4.5 GHz
- 83% Phase Velocity
- Double Shielded
- PVC Jacket

Applications

- General Purpose
- Laboratory Use

Description

Pasternack's PE38132/BK-12 75 ohm BNC male to 75 ohm BNC female bulkhead 12 inch cable using 75 ohm PE-B159-BK coax is part of our full line of RF components available for same-day shipping. Pasternack's flexible RF cable assemblies are ideal for applications where tight bends and flexure are required. This Pasternack BNC to BNC cable assembly has a male to female gender configuration with 75 ohm flexible MINI 59 coax. The PE38132/BK-12 BNC male to BNC female cable assembly operates to 4.5 GHz. Our RF cable assembly with BNC bulkhead interface allows designers to create external connections on their product enclosures, and can be used in a variety of other rack mount and panel mount applications. The double shielding of this Pasternack cable assembly provides excellent shielding effectiveness.

Custom versions of most RF cable assemblies can be built and shipped same day. Custom cable assembly lengths can be obtained by specifying the desired length on the web site at time of order or by contacting a sales representative. Other available RF cable assembly value added services include connector orientation or clocking, heat shrink booting and custom labeling. RF testing can also be performed to document the electrical performance of your cable assembly.

Click the following link (or enter part number in "SEARCH" on website) to obtain additional part information including price, inventory and certifications: [75 Ohm BNC Male to 75 Ohm BNC Female Bulkhead Cable 12 Inch Length Using 75 Ohm PE-B159-BK Black Coax PE38132/BK-12](#)



75 Ohm BNC Male to 75 Ohm BNC Female Bulkhead Cable
 12 Inch Length Using 75 Ohm PE-B159-BK Black Coax

RF Cable Assemblies Technical Data Sheet

PE38132/BK-12

Electrical Specifications

Description	Minimum	Typical	Maximum	Units
Frequency Range	DC		4.5	GHz
Velocity of Propagation		83		%
Capacitance		16.5 [54.13]		pF/ft [pF/m]
DC Current			5	Amps
Operating Voltage (AC)			300	Vrms

Specifications by Frequency

Description	F1	F2	F3	F4	F5	Units
Frequency	1	2.25	3	4.5		GHz
Insertion Loss (Typ.)	0.059	0.27	0.72	0.93		dB
Return Loss (Max.)	36	24	20	17		dB

Mechanical Specifications

Cable Assembly

Length*	12 in [304.8 mm]
Diameter	0.57 in [14.48 mm]
Weight	0.0569 lbs [25.81 g]

Cable

Cable Type	MINI 59
Impedance	75 Ohms
Inner Conductor Type	Solid
Inner Conductor Material and Plating	Copper
Dielectric Type	PE (F)
Number of Shields	2
Shield Layer 1	Aluminum Tape
Shield Layer 2	Tinned Copper Braid
Jacket Material	PVC, Black
Jacket Diameter	0.159 in [4.04 mm]

One Time Minimum Bend Radius	1.5 in [38.1 mm]
------------------------------	------------------

Click the following link (or enter part number in "SEARCH" on website) to obtain additional part information including price, inventory and certifications: [75 Ohm BNC Male to 75 Ohm BNC Female Bulkhead Cable 12 Inch Length Using 75 Ohm PE-B159-BK Black Coax PE38132/BK-12](#)



75 Ohm BNC Male to 75 Ohm BNC Female Bulkhead Cable
12 Inch Length Using 75 Ohm PE-B159-BK Black Coax

RF Cable Assemblies Technical Data Sheet

PE38132/BK-12

Connectors

Description	Connector 1	Connector 2
Type	BNC Male	BNC Female Bulkhead
Impedance	75 Ohms	75 Ohms
Contact Material and Plating	Brass, Gold	Phosphor Bronze, Gold
Dielectric Type	HDPE	HDPE
Body Material and Plating	Brass, Nickel	Brass, Nickel

Compliance Certifications (see [product page](#) for current document)

Plotted and Other Data

Notes:

- Values at 25°C, sea level.

Click the following link (or enter part number in "SEARCH" on website) to obtain additional part information including price, inventory and certifications: [75 Ohm BNC Male to 75 Ohm BNC Female Bulkhead Cable 12 Inch Length Using 75 Ohm PE-B159-BK Black Coax PE38132/BK-12](#)



75 Ohm BNC Male to 75 Ohm BNC Female Bulkhead Cable
12 Inch Length Using 75 Ohm PE-B159-BK Black Coax

RF Cable Assemblies Technical Data Sheet

PE38132/BK-12

How to Order

Part Number Configuration:

PE38132/BK - xx uu

Unit of Measure:
cm = Centimeters
<blank> = Inches
Length
Base Number

Example: PE38132/BK-12 = 12 inches long cable
PE38132/BK-100cm = 100 cm long cable

75 Ohm BNC Male to 75 Ohm BNC Female Bulkhead Cable 12 Inch Length Using 75 Ohm PE-B159-BK Black Coax from Pasternack Enterprises has same day shipment for domestic and International orders. Our RF, microwave and millimeter wave products maintain a 99.4% availability and are part of the broadest selection in the industry.

Click the following link (or enter part number in "SEARCH" on website) to obtain additional part information including price, inventory and certifications: [75 Ohm BNC Male to 75 Ohm BNC Female Bulkhead Cable 12 Inch Length Using 75 Ohm PE-B159-BK Black Coax PE38132/BK-12](#)

URL: <https://www.pasternack.com/bnc-male-bnc-female-pe-b159-bk-cable-assembly-pe38132-bk-12-p.aspx>

The information contained in this document is accurate to the best of our knowledge and representative of the part described herein. It may be necessary to make modifications to the part and/or the documentation of the part, in order to implement improvements. Pasternack reserves the right to make such changes as required. Unless otherwise stated, all specifications are nominal. Pasternack does not make any representation or warranty regarding the suitability of the part described herein for any particular purpose, and Pasternack does not assume any liability arising out of the use of any part or documentation.

PE38132/BK-12 CAD Drawing

75 Ohm BNC Male to 75 Ohm BNC Female Bulkhead Cable
12 Inch Length Using 75 Ohm PE-B159-BK Black Coax

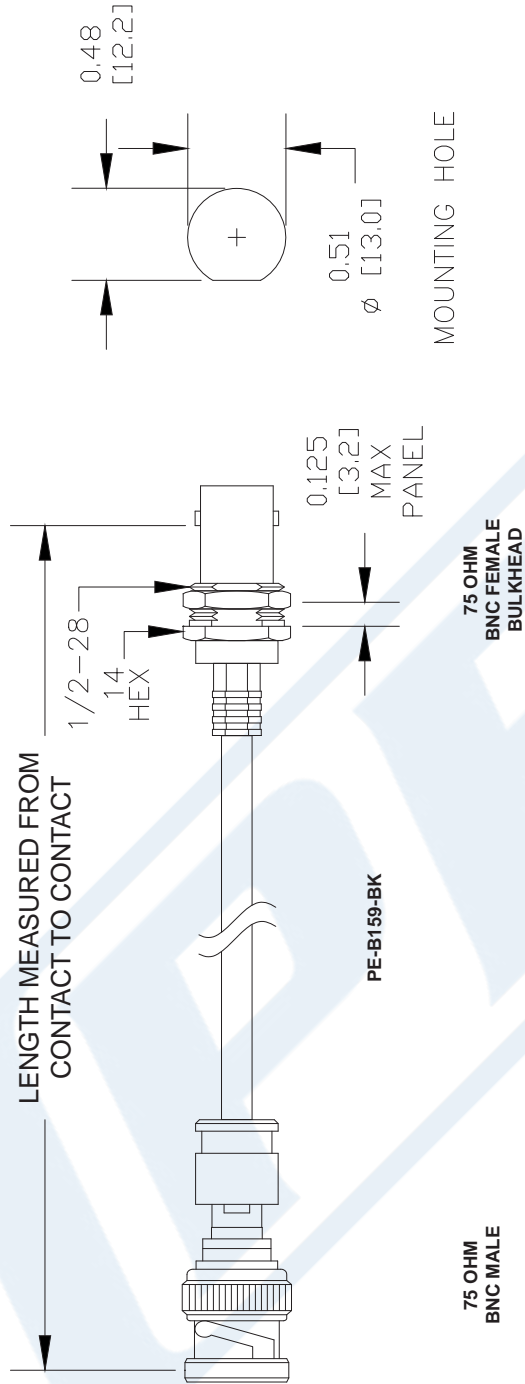

How To Order		Part # Ext.	Length In Inches	Part # Ext.	Length In Centimeters
Part Number Configuration	Examples	-12	12"	-25CM	25Cm
PE3 [zzz] [yy] - [xx] [uu]	PE3000LF-100	-24	24"	-50CM	50Cm
00 - 99999	PE3000-100	-36	36"	-75CM	75Cm
LF = RoHS Compliant	PE3000LF-100CM	-48	48"	-100CM	100Cm
< Blank > = Standard	PE3000-100CM	-60	60"	-125CM	125Cm
Note: LF applies only to RF cables		-xx	Custom Length	-xxCM	Custom Length

NOTES:
1. UNLESS OTHERWISE SPECIFIED ALL DIMENSIONS ARE NOMINAL.
2. ALL SPECIFICATIONS ARE SUBJECT TO CHANGE WITHOUT NOTICE AT ANY TIME.
3. DIMENSIONS ARE IN INCHES [mm].
4. LENGTH TOLERANCE IS ± 1.5% OR 3/8", WHICHEVER IS GREATER.

DWG TITLE
PE38132-BK

PE PASTERNAK®
Pasternack Enterprises, Inc.
P.O. Box 16759 | Irvine | CA | 92623
Phone: (949) 261-1920 | Fax: (949) 261-7451
Website: www.pasternack.com | E-Mail: sales@pasternack.com

FSCM NO. 53919	CAD FILE 41613	SCALE N/A	SIZE A
----------------	----------------	-----------	--------