



## N Male Right Angle Connector Crimp/ Solder Attachment for RG213, RG8

### RF Connectors Technical Data Sheet

PE4482

#### Configuration

- N Male Connector
- MIL-STD-348A
- 50 Ohms
- Right Angle Body Geometry
- Connector Interface Types: RG213, RG8

#### Features

- Max. Operating Frequency 11 GHz
- Gold Plated Brass Contact
- 30  $\mu$ m minimum contact plating

#### Applications

- General Purpose Test
- Custom Cable Assemblies

#### Description

Pasternack's PE4482 type N male right angle connector with crimp/solder attachment for RG213 and RG8 is part of our full line of RF components available for same-day shipping. Our type N male connector operates up to a maximum frequency of 11 GHz. Its right angle body geometry allows for easier connections in tight spaces.

Our type N male right angle connector PE4482 datasheet specifications and drawing with dimensions are shown below in this PDF. Pasternack's broad catalog of RF, microwave and millimeter wave connectors allows designers to configure and customize their signal connections however they like. Whether the need is to provide an I/O for a board design, or simply create a custom cable assembly configuration, Pasternack has the right connector for the job. Pasternack can also expertly build your custom cable assemblies for you and ship same-day.

#### Electrical Specifications

Description	Minimum	Typical	Maximum	Units
Frequency Range	DC		11	GHz
Operating Voltage (AC)			1,500	Vrms
Dielectric Withstanding Voltage (AC)			2,500	Vrms
Inner Conductor DC Resistance			1	mOhms
Outer Conductor DC Resistance			1	mOhms
Insulation Resistance	5,000			MOhms
RF Leakage	90			dB

#### Performance by Frequency

Description	F1	F2	F3	F4	F5	Units
Frequency Range	DC to 6					GHz
VSWR, Max	1.5:1					
Insertion Loss, Max	0.15					dB

Click the following link (or enter part number in "SEARCH" on website) to obtain additional part information including price, inventory and certifications: [N Male Right Angle Connector Crimp/Solder Attachment for RG213, RG8 PE4482](#)



N Male Right Angle Connector Crimp/  
Solder Attachment for RG213, RG8

RF Connectors  
Technical Data Sheet

PE4482

**Mechanical Specifications**

<b>Size</b>	
Length	1.99 in [50.55 mm]
Width/Dia.	0.8 in [20.32 mm]
Height	1.29 in [32.77 mm]
Weight	0.151 lbs [68.49 g]
Mating Cycles	500 Cycles

**Material Specifications**

Description	Material	Plating
Contact	Brass	Gold 30 µin minimum
Insulation	PTFE	
Body	Brass	Nickel 100 µin minimum
Coupling Nut	Brass	Nickel
Crimp Sleeve	Brass	Nickel

**Environmental Specifications**

<b>Temperature</b>	
Operating Range	-65 to +165 deg C
Vibration	MIL-STD-202, Method 204, Condition B
Temperature Cycle	MIL-STD-202, Method 107, Condition B
Salt Spray	MIL-STD-202, Method 101, Condition B

**Compliance Certifications** (see [product page](#) for current document)

**Plotted and Other Data**

Notes:

Click the following link (or enter part number in "SEARCH" on website) to obtain additional part information including price, inventory and certifications: [N Male Right Angle Connector Crimp/Solder Attachment for RG213, RG8 PE4482](#)



## N Male Right Angle Connector Crimp/ Solder Attachment for RG213, RG8

### RF Connectors Technical Data Sheet

PE4482

N Male Right Angle Connector Crimp/Solder Attachment for RG213, RG8 from Pasternack Enterprises has same day shipment for domestic and International orders. Our RF, microwave and millimeter wave products maintain a 99.4% availability and are part of the broadest selection in the industry.

Click the following link (or enter part number in "SEARCH" on website) to obtain additional part information including price, inventory and certifications: [N Male Right Angle Connector Crimp/Solder Attachment for RG213, RG8 PE4482](https://www.pasternack.com/n-male-standard-rg213-rg8-connector-pe4482-p.aspx)

URL: <https://www.pasternack.com/n-male-standard-rg213-rg8-connector-pe4482-p.aspx>

The information contained in this document is accurate to the best of our knowledge and representative of the part described herein. It may be necessary to make modifications to the part and/or the documentation of the part, in order to implement improvements. Pasternack reserves the right to make such changes as required. Unless otherwise stated, all specifications are nominal. Pasternack does not make any representation or warranty regarding the suitability of the part described herein for any particular purpose, and Pasternack does not assume any liability arising out of the use of any part or documentation.

# PE4482 CAD Drawing

N Male Right Angle Connector Crimp/Solder Attachment for RG213, RG8

REVISIONS			
REV.	DESCRIPTION	DATE	APPROVED
1.2	PCR PE4482 20190529	07/15/19	SELLIS

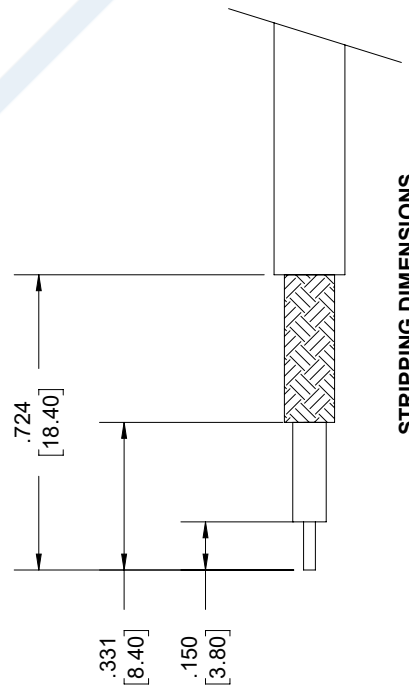
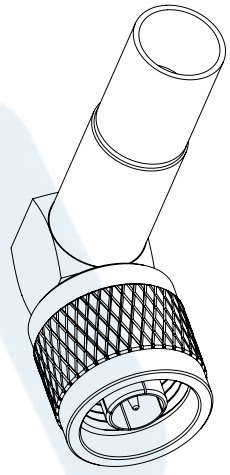
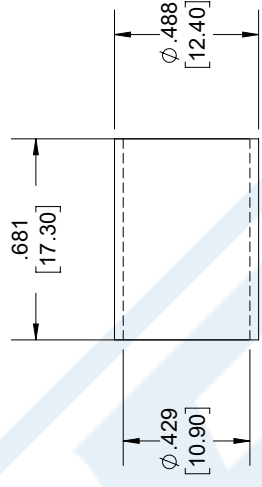
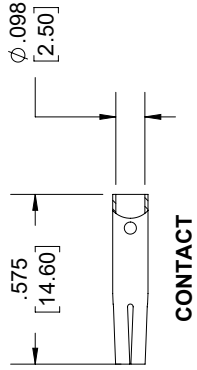
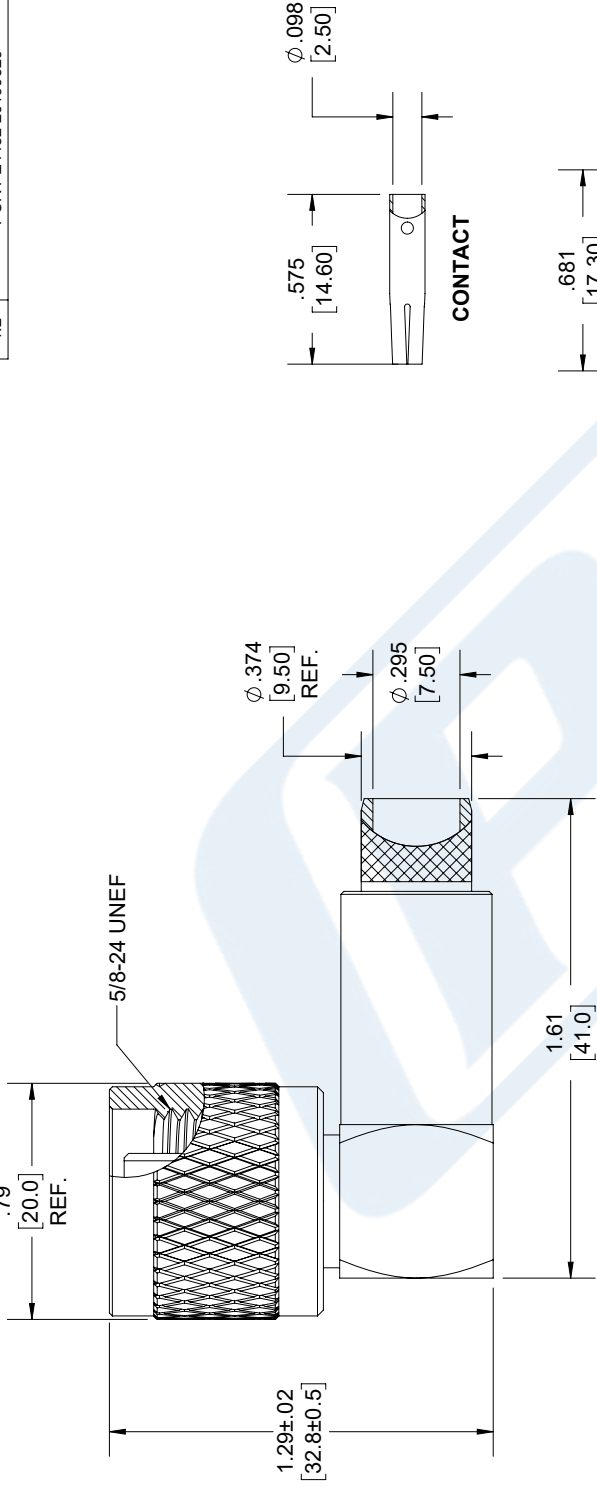

### STRIPPING DIMENSIONS

- NOTES:
- CABLE ATTACHMENT:
    - OUTER: CRIMP.
    - INNER: SOLDER.
  - CRIMP SIZE REQUIRED:
    - FERRULE: .429 [10.90] HEX. CRIMP TOOL.

UNLESS OTHERWISE SPECIFIED LEADING DIMENSIONS ARE INCHES DIMENSIONS IN [ ] ARE MILLIMETERS	
TOLERANCES:	FRACTIONS
X±.2	[5.08]
.XX±.01	[.25]
.XXX±.005	[.13]
ALL DIMENSIONS SHOWN ARE FOR REFERENCE ONLY.	
THIRD-ANGLE PROJECTION	

**PE PASTERNAK**  
an INFINITO brand

Pasternack Enterprises, Inc.  
P.O. Box 16759, Irvine, CA 92623.  
Phone: 1.949.261.1920 | 1.866.727.8376  
Fax: 1.949.261.7451  
www.pasternack.com | e-mail: sales@pasternack.com

THE INFORMATION AND DESIGN IN THIS DOCUMENT IS THE PROPERTY OF PASTERNAK CORPORATION. ALL RIGHTS RESERVED.

SHEET 1 OF 1  
SCALE N/A

SIZE A CAGE DRAWN BY PART NUMBER  
53919 KDANG PE4482

THESE COMMODITIES, TECHNOLOGY OR SOFTWARE WERE EXPORTED FROM THE UNITED STATES IN ACCORDANCE WITH THE EXPORT ADMINISTRATION REGULATIONS. DIVERSION CONTRARY TO U.S. LAW PROHIBITED.



## N Male Right Angle Connector Crimp/ Solder Attachment for RG213, RG8

### RF Connectors Technical Data Sheet

PE4482

#### Configuration

- N Male Connector
- MIL-STD-348A
- 50 Ohms
- Right Angle Body Geometry
- Connector Interface Types: RG213, RG8

#### Features

- Max. Operating Frequency 11 GHz
- Gold Plated Brass Contact
- 30  $\mu$ m minimum contact plating

#### Applications

- General Purpose Test
- Custom Cable Assemblies

#### Description

Pasternack's PE4482 type N male right angle connector with crimp/solder attachment for RG213 and RG8 is part of our full line of RF components available for same-day shipping. Our type N male connector operates up to a maximum frequency of 11 GHz. Its right angle body geometry allows for easier connections in tight spaces.

Our type N male right angle connector PE4482 datasheet specifications and drawing with dimensions are shown below in this PDF. Pasternack's broad catalog of RF, microwave and millimeter wave connectors allows designers to configure and customize their signal connections however they like. Whether the need is to provide an I/O for a board design, or simply create a custom cable assembly configuration, Pasternack has the right connector for the job. Pasternack can also expertly build your custom cable assemblies for you and ship same-day.

#### Electrical Specifications

Description	Minimum	Typical	Maximum	Units
Frequency Range	DC		11	GHz
Operating Voltage (AC)			1,500	Vrms
Dielectric Withstanding Voltage (AC)			2,500	Vrms
Inner Conductor DC Resistance			1	mOhms
Outer Conductor DC Resistance			1	mOhms
Insulation Resistance	5,000			MOhms
RF Leakage	90			dB

#### Performance by Frequency

Description	F1	F2	F3	F4	F5	Units
Frequency Range	DC to 6					GHz
VSWR, Max	1.5:1					
Insertion Loss, Max	0.15					dB

Click the following link (or enter part number in "SEARCH" on website) to obtain additional part information including price, inventory and certifications: [N Male Right Angle Connector Crimp/Solder Attachment for RG213, RG8 PE4482](#)



N Male Right Angle Connector Crimp/  
Solder Attachment for RG213, RG8

RF Connectors  
Technical Data Sheet

PE4482

**Mechanical Specifications**

<b>Size</b>	
Length	1.99 in [50.55 mm]
Width/Dia.	0.8 in [20.32 mm]
Height	1.29 in [32.77 mm]
Weight	0.151 lbs [68.49 g]
Mating Cycles	500 Cycles

**Material Specifications**

Description	Material	Plating
Contact	Brass	Gold 30 µin minimum
Insulation	PTFE	
Body	Brass	Nickel 100 µin minimum
Coupling Nut	Brass	Nickel
Crimp Sleeve	Brass	Nickel

**Environmental Specifications**

<b>Temperature</b>	
Operating Range	-65 to +165 deg C
Vibration	MIL-STD-202, Method 204, Condition B
Temperature Cycle	MIL-STD-202, Method 107, Condition B
Salt Spray	MIL-STD-202, Method 101, Condition B

**Compliance Certifications** (see [product page](#) for current document)

**Plotted and Other Data**

Notes:

Click the following link (or enter part number in "SEARCH" on website) to obtain additional part information including price, inventory and certifications: [N Male Right Angle Connector Crimp/Solder Attachment for RG213, RG8 PE4482](#)



## N Male Right Angle Connector Crimp/ Solder Attachment for RG213, RG8

### RF Connectors Technical Data Sheet

PE4482

N Male Right Angle Connector Crimp/Solder Attachment for RG213, RG8 from Pasternack Enterprises has same day shipment for domestic and International orders. Our RF, microwave and millimeter wave products maintain a 99.4% availability and are part of the broadest selection in the industry.

Click the following link (or enter part number in "SEARCH" on website) to obtain additional part information including price, inventory and certifications: [N Male Right Angle Connector Crimp/Solder Attachment for RG213, RG8 PE4482](https://www.pasternack.com/n-male-standard-rg213-rg8-connector-pe4482-p.aspx)

URL: <https://www.pasternack.com/n-male-standard-rg213-rg8-connector-pe4482-p.aspx>

The information contained in this document is accurate to the best of our knowledge and representative of the part described herein. It may be necessary to make modifications to the part and/or the documentation of the part, in order to implement improvements. Pasternack reserves the right to make such changes as required. Unless otherwise stated, all specifications are nominal. Pasternack does not make any representation or warranty regarding the suitability of the part described herein for any particular purpose, and Pasternack does not assume any liability arising out of the use of any part or documentation.

# PE4482 CAD Drawing

N Male Right Angle Connector Crimp/Solder Attachment for RG213, RG8

REVISIONS			
REV.	DESCRIPTION	DATE	APPROVED
1.2	PCR PE4482 20190529	07/15/19	SELLIS

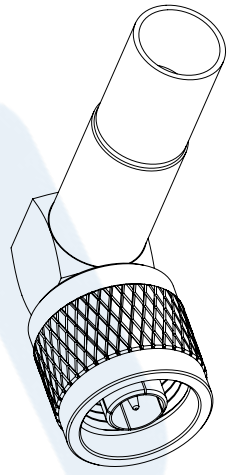
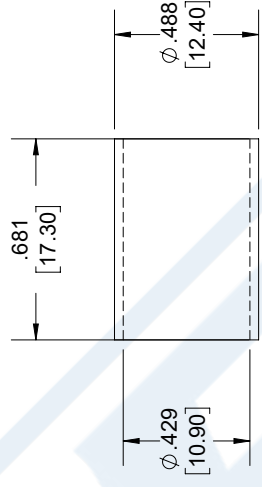
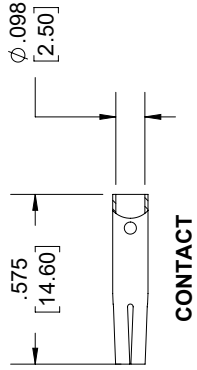
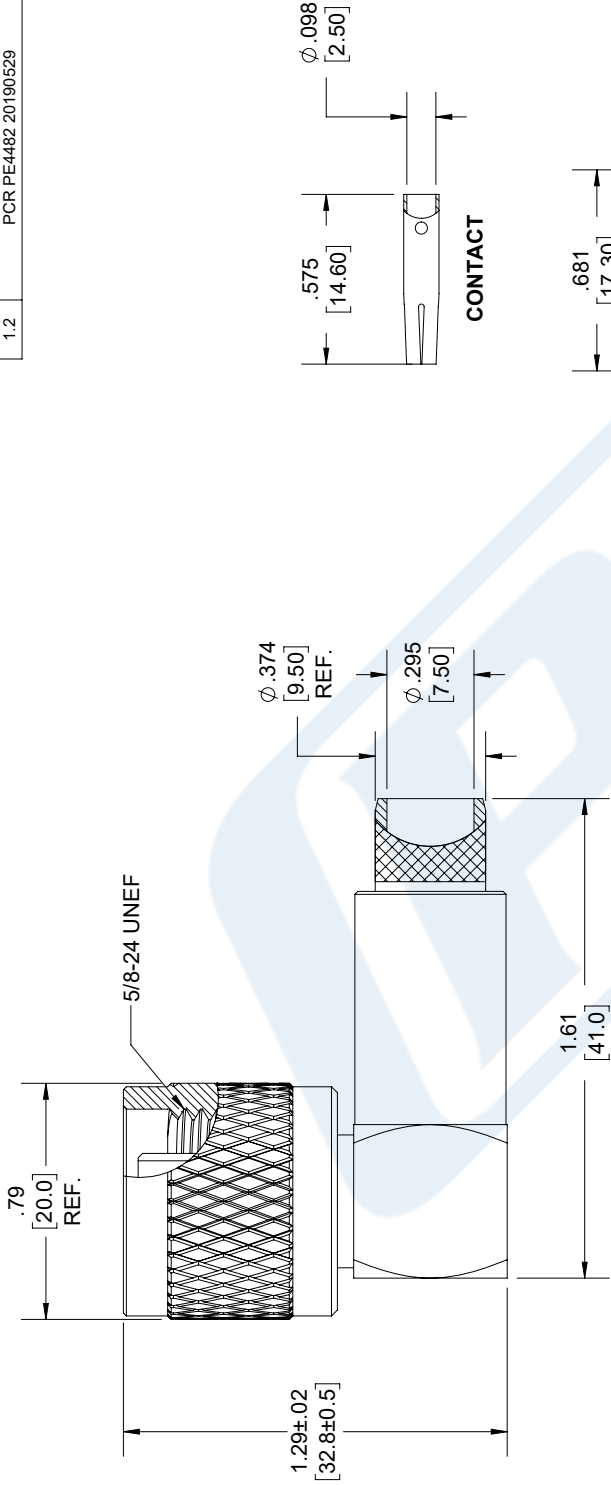

### STRIPPING DIMENSIONS

- NOTES:
- CABLE ATTACHMENT:
    - OUTER: CRIMP.
    - INNER: SOLDER.
  - CRIMP SIZE REQUIRED:
    - FERRULE: .429 [10.90] HEX. CRIMP TOOL.

UNLESS OTHERWISE SPECIFIED LEADING DIMENSIONS ARE INCHES DIMENSIONS IN [ ] ARE MILLIMETERS	THE INFORMATION AND DESIGN IN THIS DOCUMENT IS THE PROPERTY OF PASTERNAK CORPORATION. ALL RIGHTS RESERVED.
TOLERANCES: X±.2 [5.08] .XX±.01 [0.25] .XXX±.005 [0.13]	FRACTIONS ±.132 ANGLES ± 1°
ALL DIMENSIONS SHOWN ARE FOR REFERENCE ONLY.	SHEET 1 OF 1
THIRD-ANGLE PROJECTION	SCALE N/A
	REV 1.2

**PE PASTERNAK**  
an INFINITO brand

Pasternack Enterprises, Inc.  
P.O. Box 16759, Irvine, CA 92623.  
Phone: 1.949.261.1920 | 1.866.727.8376  
Fax: 1.949.261.7451  
www.pasternack.com | e-mail: sales@pasternack.com

SIZE A CAGE 53919 DRAWN BY KDANG PART NUMBER PE4482

THESE COMMODITIES, TECHNOLOGY OR SOFTWARE WERE EXPORTED FROM THE UNITED STATES IN ACCORDANCE WITH THE EXPORT ADMINISTRATION REGULATIONS. DIVERSION CONTRARY TO U.S. LAW PROHIBITED.



## Flexible RG8 Coax Cable Single Shielded with Black PVC (NC) Jacket

### RF Cables Technical Data Sheet

RG8A/U

#### Times Microwave Systems Coax Cable Specification Configuration

- Flexible Cable
- 1 Shield(s)

#### Electrical Specifications

Description	Minimum	Typical	Maximum	Units
Frequency Range	DC		1,000	MHz
Impedance		50		Ohms
Velocity of Propagation		66		%
Nominal Capacitance		30.8 [101.05]		pF/ft [pF/m]

#### Performance by Frequency Band

Description	F1	F2	F3	F4	F5	Units
Frequency	1	10	50	400	700	MHz
Attenuation, Typ	0.2	0.6	1.3	4.1	6.5	dB/100ft
	0.66	1.97	4.27	13.45	21.33	dB/100m

Description	F6	F7	F8	F9	F10	Units
Frequency	900	1,000				MHz
Attenuation, Typ	7.6	8				dB/100ft
	24.93	26.25				dB/100m

#### Mechanical Specifications

Diameter	0.405 in [10.29 mm]
Weight	0.105 lbs/ft [0.16 Kg/m]

#### Construction Specifications

Description	Material and Plating	Diameter
Inner Conductor	Copper, 7 Strands	0.085 in [2.16 mm]

Click the following link (or enter part number in "SEARCH" on website) to obtain additional part information including price, inventory and certifications: [Flexible RG8 Coax Cable Single Shielded with Black PVC \(NC\) Jacket RG8A/U](#)



## Flexible RG8 Coax Cable Single Shielded with Black PVC (NC) Jacket

### RF Cables Technical Data Sheet

RG8A/U

Conductor Type	Stranded	
Dielectric	PE	0.285 in [7.24 mm]
First Shield	Copper Braid	0.318 in [8.08 mm]
Jacket	PVC (NC), Black	0.405 in [10.29 mm]

#### Environmental Specifications

##### Temperature

Operating Range -40 to +80 deg C

**Compliance Certifications** (see [product page](#) for current document)

#### Plotted and Other Data

Notes:

Flexible RG8 Coax Cable Single Shielded with Black PVC (NC) Jacket from Pasternack Enterprises has same day shipment for domestic and International orders. Our RF, microwave and millimeter wave products maintain a 99.4% availability and are part of the broadest selection in the industry.

Click the following link (or enter part number in "SEARCH" on website) to obtain additional part information including price, inventory and certifications: [Flexible RG8 Coax Cable Single Shielded with Black PVC \(NC\) Jacket RG8A/U](#)

URL: <https://www.pasternack.com/flexible-0.405-rg8-52-ohm-coax-cable-pvc-jacket-rg8a-u-p.aspx>

The information contained in this document is accurate to the best of our knowledge and representative of the part described herein. It may be necessary to make modifications to the part and/or the documentation of the part, in order to implement improvements. Pasternack reserves the right to make such changes as required. Unless otherwise stated, all specifications are nominal. Pasternack does not make any representation or warranty regarding the suitability of the part described herein for any particular purpose, and Pasternack does not assume any liability arising out of the use of any part or documentation.

# RG8A/U CAD Drawing

Flexible RG8 Coax Cable Single Shielded with Black PVC (NC) Jacket

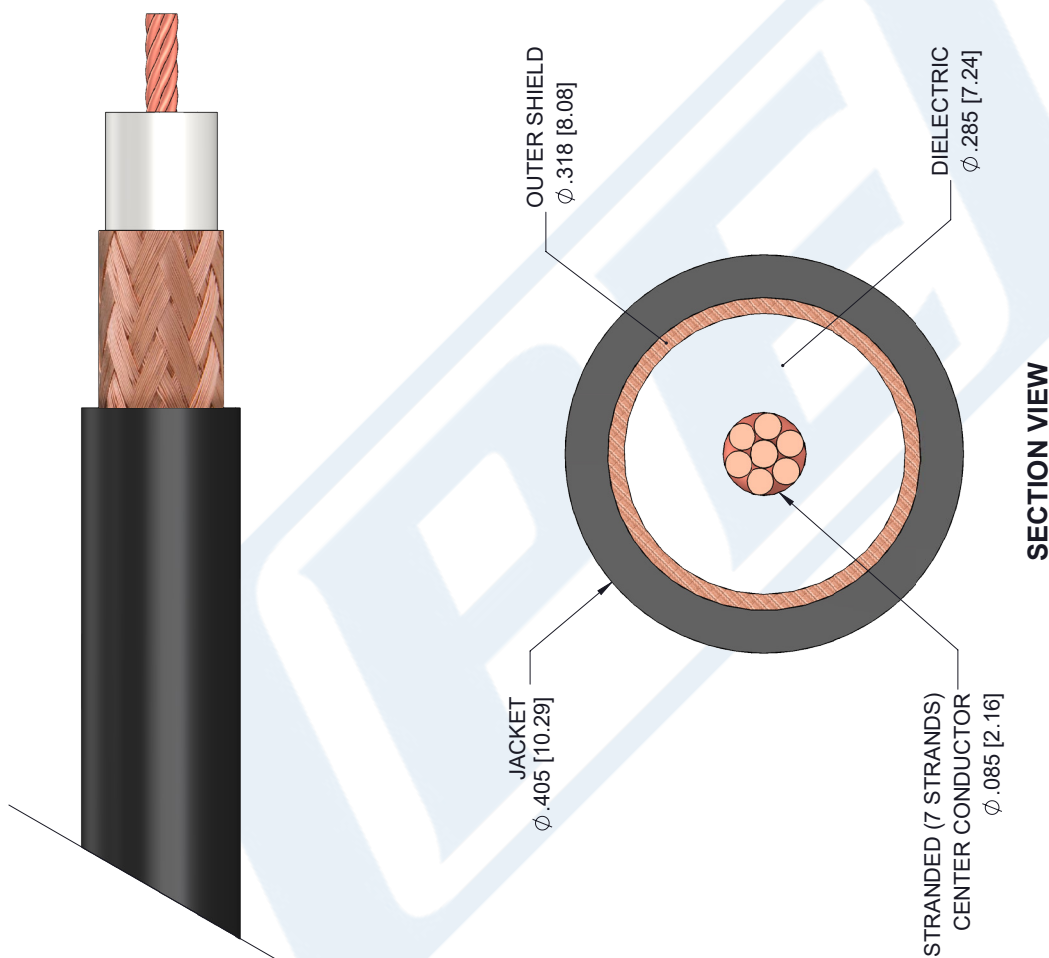

STANDARD TOLERANCES	
.X	±0.2
.XX	±0.01
.XXX	±0.005

\*STANDARD TOLERANCES APPLY ONLY TO DIMENSIONS IN INCHES



Pasternack Enterprises, Inc.  
 P.O. Box 16759 | Irvine | CA | 92623  
**Phone:** (949) 261-1920 | **Fax:** (949) 261-7451  
**Website:** [www.pasternack.com](http://www.pasternack.com) | **E-Mail:** [sales@pasternack.com](mailto:sales@pasternack.com)

DWG TITLE

RG8A/U

NOTES:  
 1. UNLESS OTHERWISE SPECIFIED ALL DIMENSIONS ARE NOMINAL.  
 2. ALL SPECIFICATIONS ARE SUBJECT TO CHANGE WITHOUT NOTICE AT ANY TIME.  
 3. DIMENSIONS ARE IN INCHES [mm].

CAGE CODE 53919

CAD FILE 12/21/18

SCALE N/A

SIZE A

7361