



N Male Right Angle Connector Clamp/Non-Solder
Contact Attachment for 1/2 inch Helical

TECHNICAL DATA SHEET

PE44554

Configuration

Connector	N Male
Connector Interface Type	1/2 inch Helical
Attachment Method (Shield/Contact)	Clamp/Non-Solder Contact
Body Style	Right Angle

Electrical Specifications

Frequency Range	DC to 3 GHz
Impedance	50 Ohms
Maximum VSWR	1.1:1
Maximum Insertion Loss	0.1 dB
Dielectric Withstanding Voltage	2,500 Vrms
Maximum Passive Intermodulation (2 x 20 Watts)	-160 dBc

Mechanical Specifications

Size

Length	2.77 in [70.36 mm]
Width/Dia.	0.75 in [19.05 mm]
Height	1.725 in [43.82 mm]
Weight	6.9 lbs [3.13 Kg]

Connector

Type	N Male
Contact Material and Plating	Brass, Tri-Metal
Coupling Nut Material and Plating	Brass, Nickel
Coupling Nut Plating Specification	196µ in. minimum
Hex Size	3/4 in.
Torque	12 in-lbs [1.36 Nm]
Body Material and Plating	Brass, Nickel
Body Plating Specification	196µ in. minimum
Dielectric Type	PTFE

Compliance Certifications (visit www.Pasternack.com for current document)

RoHS Compliant

Click the following link (or enter part number in "SEARCH" on website) to obtain additional part information including price, inventory and certifications: [N Male Right Angle Connector Clamp/Non-Solder Contact Attachment for 1/2 inch Helical PE44554](#)



N Male Right Angle Connector Clamp/Non-Solder Contact Attachment for 1/2 inch Helical

TECHNICAL DATA SHEET

PE44554

Plotted and Other Data

Notes:

- Values at +25 °C, sea level

N Male Right Angle Connector Clamp/Non-Solder Contact Attachment for 1/2 inch Helical from Pasternack Enterprises has same day shipment for domestic and International orders. Our RF, microwave and millimeter wave products maintain a 99% availability and are part of the broadest selection in the industry.

Click the following link (or enter part number in "SEARCH" on website) to obtain additional part information including price, inventory and certifications: [N Male Right Angle Connector Clamp/Non-Solder Contact Attachment for 1/2 inch Helical PE44554](#)

URL: <http://www.pasternack.com/n-male-standard-1-2-inch-helical-connector-pe44554-p.aspx>

The information contained in this document is accurate to the best of our knowledge and representative of the part described herein. It may be necessary to make modifications to the part and/or the documentation of the part, in order to implement improvements. Pasternack reserves the right to make such changes as required. Unless otherwise stated, all specifications are nominal. Pasternack does not make any representation or warranty regarding the suitability of the part described herein for any particular purpose, and Pasternack does not assume any liability arising out of the use of any part or documentation.

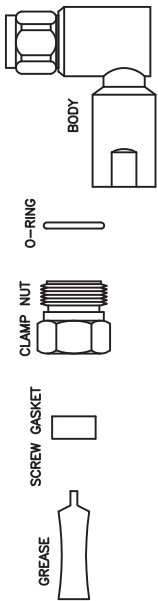

ASSEMBLY PROCEDURES

1. STRIP CABLE AS SHOWN, CHAMFER CENTER CONDUCTOR & DEBURR CABLE.

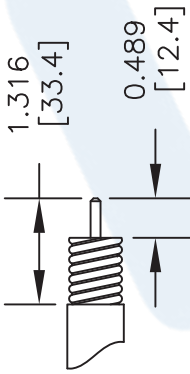

2. PUT THE SCREW GASKET ONTO CABLE, PAY ATTENTION TO THE CORRECT DIRECTION OF THE SCREW GASKET (ANGLE DIRECTION TOWARDS THE FRONT). WIPE THE GASKET WITH GREASE.

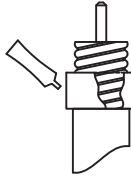

3. SCREW CLAMP NUT ONTO CABLE UNTIL EDGES OF NUT & OUTER CONDUCTOR ARE FLAT.

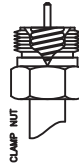

4. SLIDE O-RING OVER THREAD AND SEAT INTO PLACE. GREASE O-RING.

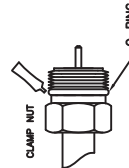

5. HOLD CLAMP NUT STEADY & SCREW BODY TIGHTLY ONTO CABLE.

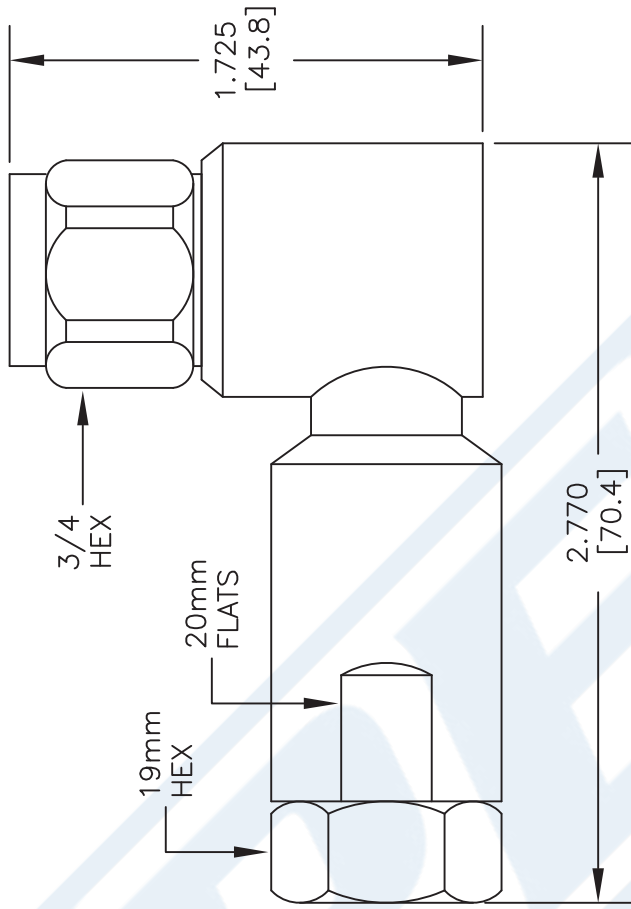

DWG TITLE

PE44554

NOTES:
 1. UNLESS OTHERWISE SPECIFIED ALL DIMENSIONS ARE NOMINAL.
 2. ALL SPECIFICATIONS ARE SUBJECT TO CHANGE WITHOUT NOTICE AT ANY TIME.
 3. DIMENSIONS ARE IN INCHES [mm].
 4. FITS MIL-C-17 AND EQUIVALENT CABLES.

PE PASTERNAK®
 Pasternack Enterprises, Inc.
 P.O. Box 16759 | Irvine | CA | 92623
 Phone: (949) 261-1920 | Fax: (949) 261-7451
 Website: www.pasternack.com | E-Mail: sales@pasternack.com

FSCM NO. 53919

CAD FILE 091813

SCALE N/A

SIZE A

2233



N Male Right Angle Connector Clamp/Non-Solder
Contact Attachment for 1/2 inch Helical

TECHNICAL DATA SHEET

PE44554

Configuration

Connector	N Male
Connector Interface Type	1/2 inch Helical
Attachment Method (Shield/Contact)	Clamp/Non-Solder Contact
Body Style	Right Angle

Electrical Specifications

Frequency Range	DC to 3 GHz
Impedance	50 Ohms
Maximum VSWR	1.1:1
Maximum Insertion Loss	0.1 dB
Dielectric Withstanding Voltage	2,500 Vrms
Maximum Passive Intermodulation (2 x 20 Watts)	-160 dBc

Mechanical Specifications

Size

Length	2.77 in [70.36 mm]
Width/Dia.	0.75 in [19.05 mm]
Height	1.725 in [43.82 mm]
Weight	6.9 lbs [3.13 Kg]

Connector

Type	N Male
Contact Material and Plating	Brass, Tri-Metal
Coupling Nut Material and Plating	Brass, Nickel
Coupling Nut Plating Specification	196µ in. minimum
Hex Size	3/4 in.
Torque	12 in-lbs [1.36 Nm]
Body Material and Plating	Brass, Nickel
Body Plating Specification	196µ in. minimum
Dielectric Type	PTFE

Compliance Certifications (visit www.Pasternack.com for current document)

RoHS Compliant

Click the following link (or enter part number in "SEARCH" on website) to obtain additional part information including price, inventory and certifications: [N Male Right Angle Connector Clamp/Non-Solder Contact Attachment for 1/2 inch Helical PE44554](#)



N Male Right Angle Connector Clamp/Non-Solder Contact Attachment for 1/2 inch Helical

TECHNICAL DATA SHEET

PE44554

Plotted and Other Data

Notes:

- Values at +25 °C, sea level

N Male Right Angle Connector Clamp/Non-Solder Contact Attachment for 1/2 inch Helical from Pasternack Enterprises has same day shipment for domestic and International orders. Our RF, microwave and millimeter wave products maintain a 99% availability and are part of the broadest selection in the industry.

Click the following link (or enter part number in "SEARCH" on website) to obtain additional part information including price, inventory and certifications: [N Male Right Angle Connector Clamp/Non-Solder Contact Attachment for 1/2 inch Helical PE44554](#)

URL: <http://www.pasternack.com/n-male-standard-1-2-inch-helical-connector-pe44554-p.aspx>

The information contained in this document is accurate to the best of our knowledge and representative of the part described herein. It may be necessary to make modifications to the part and/or the documentation of the part, in order to implement improvements. Pasternack reserves the right to make such changes as required. Unless otherwise stated, all specifications are nominal. Pasternack does not make any representation or warranty regarding the suitability of the part described herein for any particular purpose, and Pasternack does not assume any liability arising out of the use of any part or documentation.

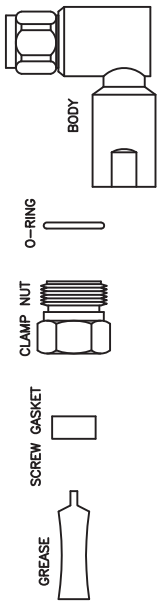

ASSEMBLY PROCEDURES

1. STRIP CABLE AS SHOWN, CHAMFER CENTER CONDUCTOR & DEBURR CABLE.

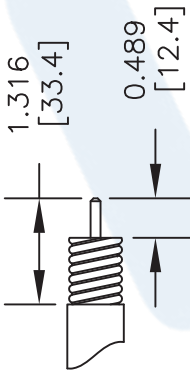

2. PUT THE SCREW GASKET ONTO CABLE, PAY ATTENTION TO THE CORRECT DIRECTION OF THE SCREW GASKET (ANGLE DIRECTION TOWARDS THE FRONT). WIPE THE GASKET WITH GREASE.

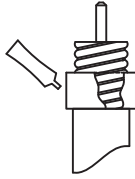

3. SCREW CLAMP NUT ONTO CABLE UNTIL EDGES OF NUT & OUTER CONDUCTOR ARE FLAT.

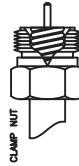

4. SLIDE O-RING OVER THREAD AND SEAT INTO PLACE. GREASE O-RING.

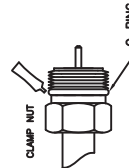

5. HOLD CLAMP NUT STEADY & SCREW BODY TIGHTLY ONTO CABLE.

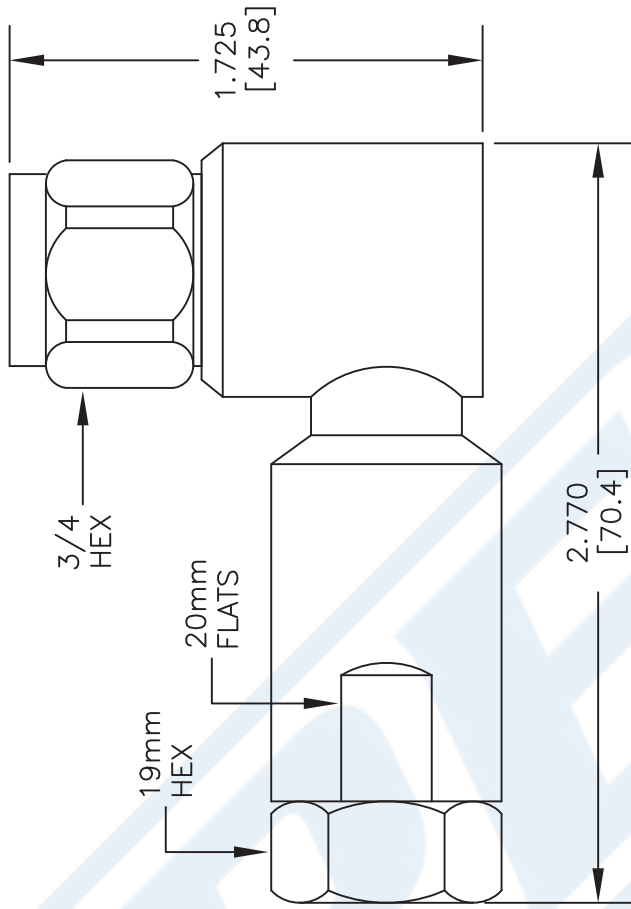
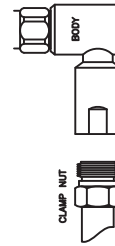

DWG TITLE

PE44554

NOTES:
 1. UNLESS OTHERWISE SPECIFIED ALL DIMENSIONS ARE NOMINAL.
 2. ALL SPECIFICATIONS ARE SUBJECT TO CHANGE WITHOUT NOTICE AT ANY TIME.
 3. DIMENSIONS ARE IN INCHES [mm].
 4. FITS MIL-C-17 AND EQUIVALENT CABLES.

PE PASTERNAK®
 Pasternack Enterprises, Inc.
 P.O. Box 16759 | Irvine | CA | 92623
 Phone: (949) 261-1920 | Fax: (949) 261-7451
 Website: www.pasternack.com | E-Mail: sales@pasternack.com

FSCM NO. 53919

CAD FILE 091813

SCALE N/A

SIZE A

2233



Low Loss 1/2 inch Superflexible Corrugated Coax Cable with Black PE Jacket

RF Cables Technical Data Sheet

PE-1/2SFHC

Configuration

- Low Loss Corrugated Cable
- 1 Shield(s)

Features

- Low Passive Intermodulation
- Solid copper outer conductor provides the highest possible RF shielding
- Superflexible helically corrugated copper outer conductor enables a small bending radius
- Excellent return loss performance
- Highly foamed dielectric provides low attenuation

Description

Our corrugated cables and Low PIM connector combinations result in cable assemblies with excellent Passive Intermodulation performance. Solid copper outer conductors provide the highest possible RF shielding. This Superflexible cable features excellent return loss performance. The highly foamed dielectric and optimized dimensions of these cables result in excellent low attenuation values. The Superflexible helically corrugated copper outer conductor allows for a small bending radius.

Electrical Specifications

Description	Minimum	Typical	Maximum	Units
Frequency Range	DC		10.2	GHz
Cutoff Frequency		13		GHz
Impedance		50		Ohms
Velocity of Propagation		82		%
Shielding Effectiveness	120			dB
Operating Voltage (AC)			1,000	Vrms
Dielectric Withstanding Voltage (AC)			2,500	Vrms
Inner Conductor DC Resistance			0.91	Ohms/1000ft
Outer Conductor DC Resistance			1.08	Ohms/1000ft
Nominal Capacitance		25.3 [83.01]		pF/ft [pF/m]
Nominal Inductance		0.059 [0.19]		uH/ft [uH/m]

Click the following link (or enter part number in "SEARCH" on website) to obtain additional part information including price, inventory and certifications: [Low Loss 1/2 inch Superflexible Corrugated Coax Cable with Black PE Jacket PE-1/2SFHC](#)



Low Loss 1/2 inch Superflexible Corrugated Coax Cable with Black PE Jacket

RF Cables Technical Data Sheet

PE-1/2SFHC

Performance by Frequency Band

Description	F1	F2	F3	F4	F5	Units
Frequency	0.1	0.45	0.9	1	1.8	GHz
Attenuation, Typ	1.01	2.22	3.22	3.41	4.72	dB/100ft
	3.31	7.28	10.56	11.19	15.49	dB/100m
Input Power (CW), Max	2,590	1,180	810	770	560	Watts

Description	F6	F7	F8	F9	F10	Units
Frequency	2	3	4	5	6	GHz
Attenuation, Typ	5.01	6.3	7.44	8.48	9.44	dB/100ft
	16.44	20.67	24.41	27.82	30.97	dB/100m
Input Power (CW), Max	530	420	350	31	280	Watts

Mechanical Specifications

Diameter	0.519 in [13.18 mm]
Weight	0.132 lbs/ft [0.2 Kg/m]
Number of Bends, Min	20
Min. Bend Radius (Installation)	0.6 in [15.24 mm]
Min. Bend Radius (Repeated)	1.18 in [29.97 mm]
Tensile Strength	79 lbs [35.83 kg]

Construction Specifications

Description	Material and Plating	Diameter
Inner Conductor	Copper Clad Aluminum ¹	0.141 in 3.58 mm
Conductor Type	Solid	
Dielectric	PE (F)	0.378 in 9.6 mm
Outer Conductor	Helically Corrugated Copper Tube	0.468 in 11.89 mm
Jacket	PE, Black	0.519 in [13.18 mm]

Click the following link (or enter part number in "SEARCH" on website) to obtain additional part information including price, inventory and certifications: [Low Loss 1/2 inch Superflexible Corrugated Coax Cable with Black PE Jacket PE-1/2SFHC](#)



Low Loss 1/2 inch Superflexible Corrugated Coax Cable with Black PE Jacket

RF Cables Technical Data Sheet

PE-1/2SFHC

Environmental Specifications

Temperature

Operating Range

-55 to +85 deg C

Compliance Certifications (see [product page](#) for current document)

Plotted and Other Data

Notes:

Low Loss 1/2 inch Superflexible Corrugated Coax Cable with Black PE Jacket from Pasternack Enterprises has same day shipment for domestic and International orders. Our RF, microwave and millimeter wave products maintain a 99.4% availability and are part of the broadest selection in the industry.

Click the following link (or enter part number in "SEARCH" on website) to obtain additional part information including price, inventory and certifications: [Low Loss 1/2 inch Superflexible Corrugated Coax Cable with Black PE Jacket PE-1/2SFHC](#)

URL: <https://www.pasternack.com/50-ohm-low-loss-corrugated-1-2-superflexible-helical-coax-pe-1-2sfhc-p.aspx>

The information contained in this document is accurate to the best of our knowledge and representative of the part described herein. It may be necessary to make modifications to the part and/or the documentation of the part, in order to implement improvements. Pasternack reserves the right to make such changes as required. Unless otherwise stated, all specifications are nominal. Pasternack does not make any representation or warranty regarding the suitability of the part described herein for any particular purpose, and Pasternack does not assume any liability arising out of the use of any part or documentation.

PE-1/2SFHC CAD Drawing

Low Loss 1/2 inch Superflexible Corrugated Coax Cable with Black PE Jacket

REVISIONS			
REV.	DESCRIPTION	DATE	APPROVED
1.1	PCR PE-1/2SFHC 20190708	07/16/19	S.ELLIS

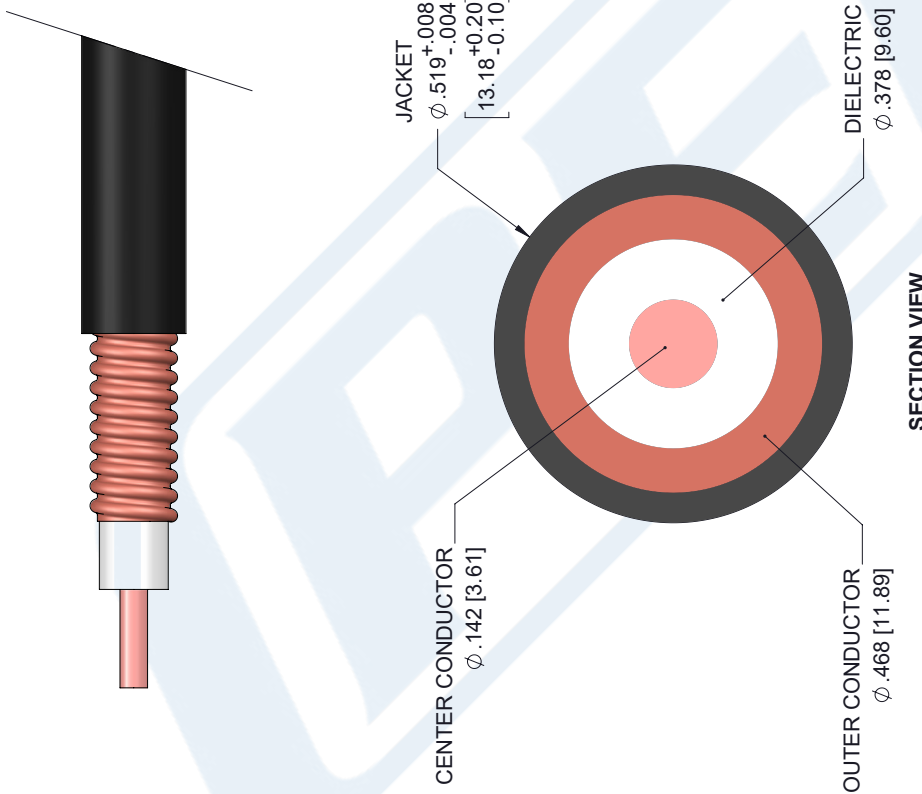

UNLESS OTHERWISE SPECIFIED LEADING DIMENSIONS ARE INCHES DIMENSIONS IN [] ARE MILLIMETERS	
TOLERANCES:	
X±.2 [5.08]	FRACTIONS ±.132
.XX±.01 [.25]	ANGLES ± 1°
.XXX±.005 [.13]	
ALL DIMENSIONS SHOWN ARE FOR REFERENCE ONLY.	
THIRD-ANGLE PROJECTION	

		THE INFORMATION AND DESIGN IN THIS DOCUMENT IS THE PROPERTY OF PASTERNAK CORPORATION. ALL RIGHTS RESERVED.	
an INFINITO brand Pasternack Enterprises, Inc. P.O. Box 16759, Irvine, CA 92623. Phone: 1.949.261.1920 1.866.727.8376 Fax: 1.949.261.7451 www.pasternack.com e-mail: sales@pasternack.com		SHEET 1 OF 1	SCALE N/A
SIZE A	CAGE 53919	DRAWN BY K.DANG	PART NUMBER PE-1/2SFHC
			REV 1.1

THESE COMMODITIES, TECHNOLOGY OR SOFTWARE WERE EXPORTED FROM THE UNITED STATES IN ACCORDANCE WITH THE EXPORT ADMINISTRATION REGULATIONS. DIVERSION CONTRARY TO U.S. LAW PROHIBITED.