

MATERIALS	
BODY	BRASS NICKEL PLATED
CONTACT	GOLD PLATED
INSULATOR	PTFE
FERRULE	GOLD PLATED

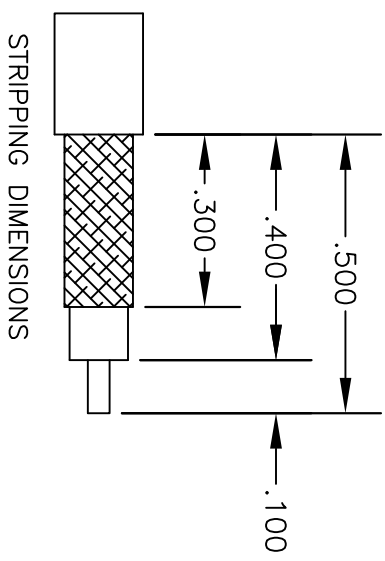
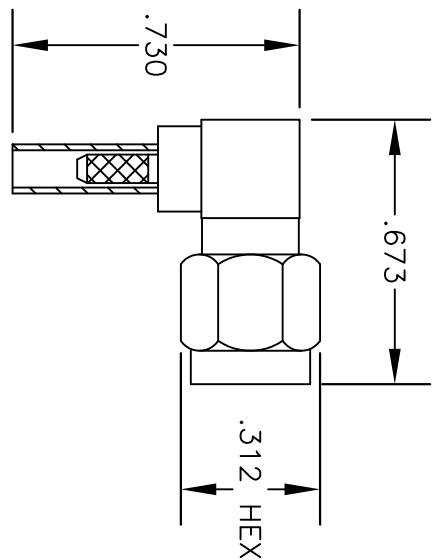

STRIPPING DIMENSIONS

ASSEMBLY PROCEDURES

1. STRIP CABLE AS SHOWN & SLIDE FERRULE OVER CABLE.
2. INSTALL CABLE INTO BODY OF CONNECTOR AND SOFT SOLDER CENTER CONDUCTOR IN PLACE.
3. SOLDER FERRULE & PRESS CAP DOWN.



PASTERNAK ENTERPRISES, INC.
 P.O. BOX 16759, IRVINE, CA 92623
 PHONE (949) 261-1920 FAX (949) 261-7451
 WEB ADDRESS: www.pasternack.com
 E-MAIL ADDRESS: sales@pasternack.com
COAXIAL & FIBER OPTICS

DWG TITLE
PE4406

DES. SMA MALE, RIGHT ANGLE, SOLDER ATTACHMENT FOR RG178 & RG196

SIZE A	FSCM NO. 53919	CAD FILE	080505	SCALE	N/A		127
--------	----------------	----------	--------	-------	-----	--	-----

NOTES:
 1. UNLESS OTHERWISE SPECIFIED ALL DIMENSIONS ARE NOMINAL.
 2. ALL SPECIFICATIONS ARE SUBJECT TO CHANGE WITHOUT NOTICE AT ANY TIME.



SMP Female Connector Solder Attachment for RG178, RG196

RF Connectors Technical Data Sheet

PE44655

Configuration

- SMP Female Connector
- MIL-STD-348
- 50 Ohms
- Straight Body Geometry
- RG178, RG196 Interface Type
- Solder/Solder Attachment

Features

- Max. Operating Frequency 3 GHz
- Excellent VSWR of 1.25:1
- Gold Plated Beryllium Copper Contact
- Contact plating according to MIL-G-45204
- Blind Mate Connector

Applications

- General Purpose Test
- Custom Cable Assemblies

Description

Pasternack's PE44655 SMP female connector with solder/solder attachment for RG178 and RG196 is part of our full line of RF components available for same-day shipping. Our SMP female connector operates up to a maximum frequency of 3 GHz and offers excellent VSWR of 1.25:1. The Pasternack blind mate connector is ideal for applications where direct visual or tactile access to the connection point is not possible, for example, when two circuit boards need to be mated.

Our SMP female connector PE44655 datasheet specifications and drawing with dimensions are shown below in this PDF. Pasternack's broad catalog of RF, microwave and millimeter wave connectors allows designers to configure and customize their signal connections however they like. Whether the need is to provide an I/O for a board design, or simply create a custom cable assembly configuration, Pasternack has the right connector for the job. Pasternack can also expertly build your custom cable assemblies for you and ship same-day.

Electrical Specifications

Description	Minimum	Typical	Maximum	Units
Frequency Range	DC		3	GHz
VSWR			1.25:1	

Mechanical Specifications

Size	
Length	0.25 in [6.35 mm]
Width/Dia.	0.135 in [3.43 mm]
Weight	0.003 lbs [1.36 g]

Click the following link (or enter part number in "SEARCH" on website) to obtain additional part information including price, inventory and certifications: [SMP Female Connector Solder Attachment for RG178, RG196 PE44655](#)



SMP Female Connector Solder Attachment for RG178, RG196

RF Connectors Technical Data Sheet

PE44655

Material Specifications

Description	Material	Plating
Contact	Beryllium Copper	Gold MIL-G-45204
Insulation	PTFE	
Body	Beryllium Copper	Gold MIL-G-45204

Environmental Specifications

Temperature

Operating Range -55 to +125 deg C

Compliance Certifications (see [product page](#) for current document)

Plotted and Other Data

Notes:

SMP Female Connector Solder Attachment for RG178, RG196 from Pasternack Enterprises has same day shipment for domestic and International orders. Our RF, microwave and millimeter wave products maintain a 99% availability and are part of the broadest selection in the industry.

Click the following link (or enter part number in "SEARCH" on website) to obtain additional part information including price, inventory and certifications: [SMP Female Connector Solder Attachment for RG178, RG196 PE44655](#)

URL: <https://www.pasternack.com/smp-female-standard-rg178-rg196-connector-pe44655-p.aspx>

The information contained in this document is accurate to the best of our knowledge and representative of the part described herein. It may be necessary to make modifications to the part and/or the documentation of the part, in order to implement improvements. Pasternack reserves the right to make such changes as required. Unless otherwise stated, all specifications are nominal. Pasternack does not make any representation or warranty regarding the suitability of the part described herein for any particular purpose, and Pasternack does not assume any liability arising out of the use of any part or documentation.

PE44655 CAD Drawing

SMP Female Connector Solder Attachment for RG178, RG196



ASSEMBLY PROCEDURES

1. INSERT HEAT SHRINK TUBE ON CABLE; STRIP CABLE TO DIMENSION SHOWN. DIP END OF CABLE INTO FLUX AND THEN TIN BRAID.

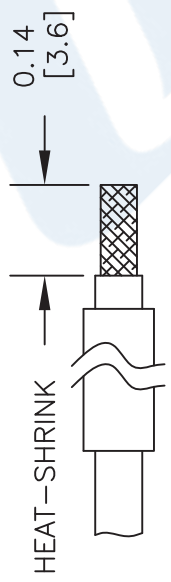

2. AFTER PRE TINNING TRIM TO DIMENSION SHOWN.

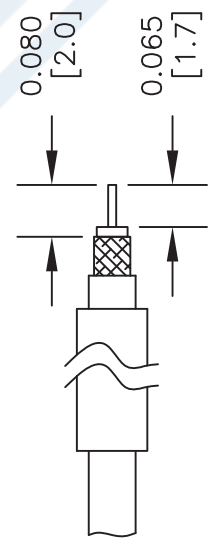

3. SOFT SOLDER CONTACT.

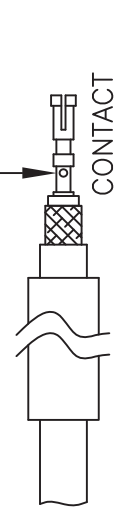

4. INSTALL CABLE INTO BODY AND SOLDER CABLE TO BODY AS SHOWN, SLIDE HEAT-SHRINK TUBE TOWARDS BODY SHOULDER AND SHRINK TO FIT.

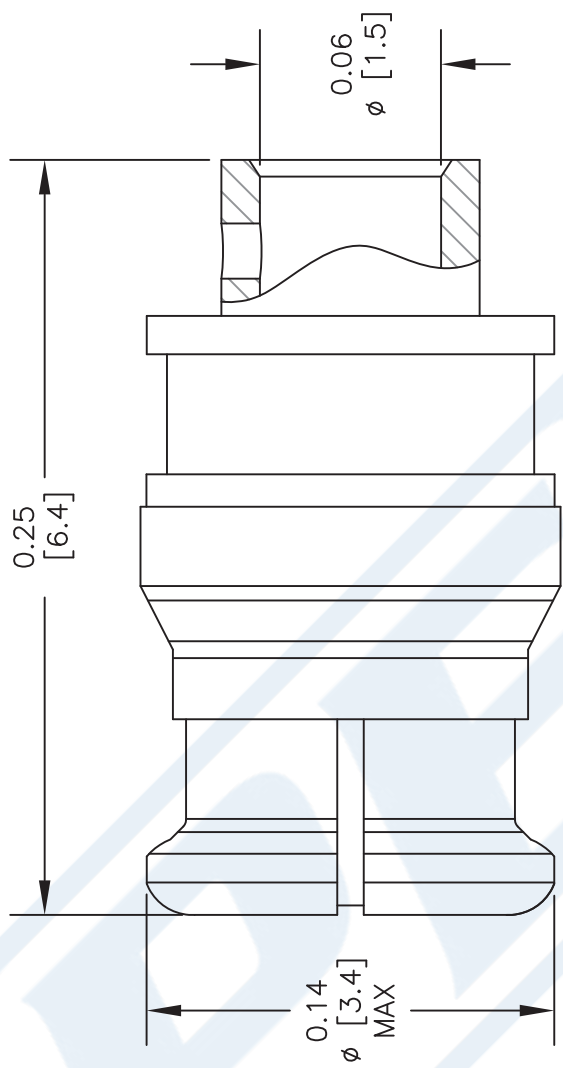
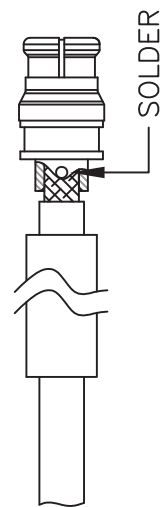

DWG TITLE

PE44655

NOTES:
 1. UNLESS OTHERWISE SPECIFIED ALL DIMENSIONS ARE NOMINAL.
 2. ALL SPECIFICATIONS ARE SUBJECT TO CHANGE WITHOUT NOTICE AT ANY TIME.
 3. DIMENSIONS ARE IN INCHES [mm].
 4. FITS MIL-C-17 AND EQUIVALENT CABLES.

FSCM NO. 53919

CAD FILE 071113

SCALE N/A

SIZE A

2233



Pasternack Enterprises, Inc.
 P.O. Box 16759 | Irvine | CA | 92623
 Phone: (949) 261-1920 | Fax: (949) 261-7451
 Website: www.pasternack.com | E-Mail: sales@pasternack.com

Flexible RG178 Coax Cable Single Shielded with Tan FEP Jacket

RF Cables Technical Data Sheet

RG178B/U

Configuration

- Flexible Cable
- 1 Shield(s)

Electrical Specifications

Description	Minimum	Typical	Maximum	Units
Frequency Range	DC		3	GHz
Impedance		50		Ohms
Velocity of Propagation		70		%
Operating Voltage (AC)			1,000	Vrms
Nominal Capacitance		29.4 [96.46]		pF/ft [pF/m]

Performance by Frequency Band

Description	F1	F2	F3	F4	F5	Units
Frequency	0.1	0.4	1	3		GHz
Attenuation, Typ	13.81	27.8	44.41	78.4		dB/100ft
	45.31	91.21	145.7	257.22		dB/100m

Mechanical Specifications

Diameter	0.072 in [1.83 mm]
Weight	0.005 lbs/ft [0.01 Kg/m]
Min. Bend Radius (Repeated)	0.4 in [10.16 mm]

Construction Specifications

Description	Material and Plating	Diameter
Inner Conductor	Copper Clad Steel, Silver, 7 Strands	0.012 in [0.3 mm]
Conductor Type	Stranded	
Dielectric	PTFE	0.034 in [0.86 mm]
First Shield	Silver Plated Copper Braid	0.051 in [1.3 mm]

Click the following link (or enter part number in "SEARCH" on website) to obtain additional part information including price, inventory and certifications: [Flexible RG178 Coax Cable Single Shielded with Tan FEP Jacket RG178B/U](#)

Flexible RG178 Coax Cable Single Shielded with Tan FEP Jacket

RF Cables Technical Data Sheet

RG178B/U

Jacket	FEP, Tan	0.072 in [1.83 mm]
--------	----------	--------------------

Environmental Specifications

Temperature

Operating Range -55 to +200 deg C

Compliance Certifications (see [product page](#) for current document)

Plotted and Other Data

Notes:

Flexible RG178 Coax Cable Single Shielded with Tan FEP Jacket from Pasternack Enterprises has same day shipment for domestic and International orders. Our RF, microwave and millimeter wave products maintain a 99.4% availability and are part of the broadest selection in the industry.

Click the following link (or enter part number in "SEARCH" on website) to obtain additional part information including price, inventory and certifications: [Flexible RG178 Coax Cable Single Shielded with Tan FEP Jacket RG178B/U](#)

URL: <https://www.pasternack.com/flexible-0.075-rg178-50-ohm-coax-cable-fep-jacket-rg178b-u-p.aspx>

The information contained in this document is accurate to the best of our knowledge and representative of the part described herein. It may be necessary to make modifications to the part and/or the documentation of the part, in order to implement improvements. Pasternack reserves the right to make such changes as required. Unless otherwise stated, all specifications are nominal. Pasternack does not make any representation or warranty regarding the suitability of the part described herein for any particular purpose, and Pasternack does not assume any liability arising out of the use of any part or documentation.

RG178B/U CAD Drawing

Flexible RG178 Coax Cable Single Shielded with Tan FEP Jacket



NOTES:
 1. UNLESS OTHERWISE SPECIFIED ALL DIMENSIONS ARE NOMINAL.
 2. ALL SPECIFICATIONS ARE SUBJECT TO CHANGE WITHOUT NOTICE AT ANY TIME.
 3. DIMENSIONS ARE IN INCHES [mm].

DWG TITLE
RG178B/U

CAGE CODE 53919

CAD FILE 062117

SCALE N/A

SIZE A

2233

PE PASTERNAK®
 THE ENGINEER'S RF SOURCE
 Pasternack Enterprises, Inc.
 P.O. Box 16759 | Irvine | CA | 92623
 Phone: (949) 261-1920 | Fax: (949) 261-7451
 Website: www.pasternack.com | E-Mail: sales@pasternack.com