

**NOTICE OF PROPRIETARY RIGHTS** THIS DOCUMENT CONTAINS CONFIDENTIAL TECHNICAL DATA, INCLUDING TRADE SECRETS, PROPRIETARY TO TIMES MICROWAVE SYSTEMS. DISCLOSURE OF THIS DATA IS EXPRESSLY CONDITIONED UPON YOUR ASSENT THAT ITS USE IS LIMITED TO USE WITHIN YOUR COMPANY ONLY. ANY OTHER USE IS STRICTLY PROHIBITED WITHOUT THE PRIOR WRITTEN CONSENT OF TIMES MICROWAVE SYSTEMS.

SYM	REVISION DESCRIPTION	DFTM	DATE	APPD	DATE
-	RELEASED FOR PRODUCTION	J. C. L.	8/20/03	J. C. L.	8/20/03
A	CHANGED PER CDC #36704	D. J. H.	1/14/13	J. D. B.	1/15/13
B	CHANGED PER CDC #37206	J. D. B.	3/226/13	J. D. B.	3/26/13



**NOTES:**

- ASSEMBLED CONNECTOR INTERFACE IS DESIGNED IN ACCORDANCE WITH MIL-STD-348.
- MATERIAL: BODY & HEX COUPLING NUT- CORROSION RESISTANT STEEL PER ASTM A582.  
CONTACT - BERYLLIUM COPPER PER ASTM B196.  
INSULATOR - TEFLON PER ASTM D1710  
GASKET - SILICONE RUBBER PER ZZ-R-765  
SHRINK SLEEVE - SHRINKABLE POLYOLEFIN PER MIL-I-23053/5  
FERRULE - D.H.P. COPPER CDA ALLOY 122
- FINISHES: BODY & HEX COUPLING NUT - PASSIVATE PER QQ-P-35  
CONTACT - GOLD PLATE PER MIL-G-45204  
FERRULE - SULFAMATE NICKEL PLATE
- CONTACT PIN IS SOLDERED.
- CRIMP THE FERRULE TO .128" HEX.

MATERIAL:	UNLESS OTHERWISE SPECIFIED		DFTM. J. C. L.	TIMES MICROWAVE SYSTEMS	
	ALL DIMENSIONS ARE IN INCHES MACHINED SURFACES FINISH N/A RMS MAX. REMOVE ALL BURRS .005 MAX. BREAK MACHINE CORNERS .005 MAX. FILLET R. TOLERANCES ON DECIMALS .XX ± .03 .XXX ± .005 ANGLES ± 1° FRACTIONS ± 1/32		DATE 8/20/03		
USED ON: A			CHKD. J. C. L.	<b>TC-100-SM</b> SMA MALE FOR LMR100 CABLE	
			DATE 8/20/03		
SCALE: N/A	DWG. SIZE A	DO NOT SCALE DRAWING	APPD. J. C. L.	DATE 8/20/03	1 of 1   SD3190-1551   B



# TIMES MICROWAVE SYSTEMS

358 Hall Avenue/P.O. Box 5039  
Wallingford, CT 06492-5039  
Tel: 203-949-8400  
FAX: 203-949-8423  
1-800-TMS-COAX  
www.timesmicrowave.com

## INSTALLATION INSTRUCTIONS TC-100-SM (TIMES 3190-1551) (Cable Types: LMR-100)



- 1) A. Trim cable to dimensions shown. Slide shrink sleeve & crimp sleeve back onto cable.  
B. Remove any residual plastic from the center conductor and deburr center conductor using a fine file.



- 2) A. Slide contact onto center conductor leaving a .020 gap as shown and solder to center conductor. Use minimal heat to minimize melting of foam dielectric. Inspect to be sure aluminum foil is not touching center contact.



- 3) A. Insert cable into connector until fully seated, with all braid wires on the outside of connector body and aluminum tape inside connector body.  
B. Slide crimp sleeve forward and crimp as close as possible to body using a .128" hex die. Use Times HX-4 crimp tool or equivalent. Do not crimp rear of crimp sleeve.  
C. Heat shrink weather seal over rear of connector body and down onto cable jacket using hot air gun.

**NOTICE OF PROPRIETARY RIGHTS** THIS DOCUMENT CONTAINS CONFIDENTIAL TECHNICAL DATA, INCLUDING TRADE SECRETS, PROPRIETARY TO TIMES MICROWAVE SYSTEMS. DISCLOSURE OF THIS DATA IS EXPRESSLY CONDITIONED UPON YOUR ASSENT THAT ITS USE IS LIMITED TO USE WITHIN YOUR COMPANY ONLY. ANY OTHER USE IS STRICTLY PROHIBITED WITHOUT THE PRIOR WRITTEN CONSENT OF TIMES MICROWAVE SYSTEMS.

SYM	REVISION DESCRIPTION	DFTM	DATE	APPD	DATE
-	RELEASED FOR PRODUCTION	J. C. L.	8/20/03	J. C. L.	8/20/03
A	CHANGED PER CDC #36704	D. J. H.	1/14/13	J. D. B.	1/15/13
B	CHANGED PER CDC #37206	J. D. B.	3/226/13	J. D. B.	3/26/13

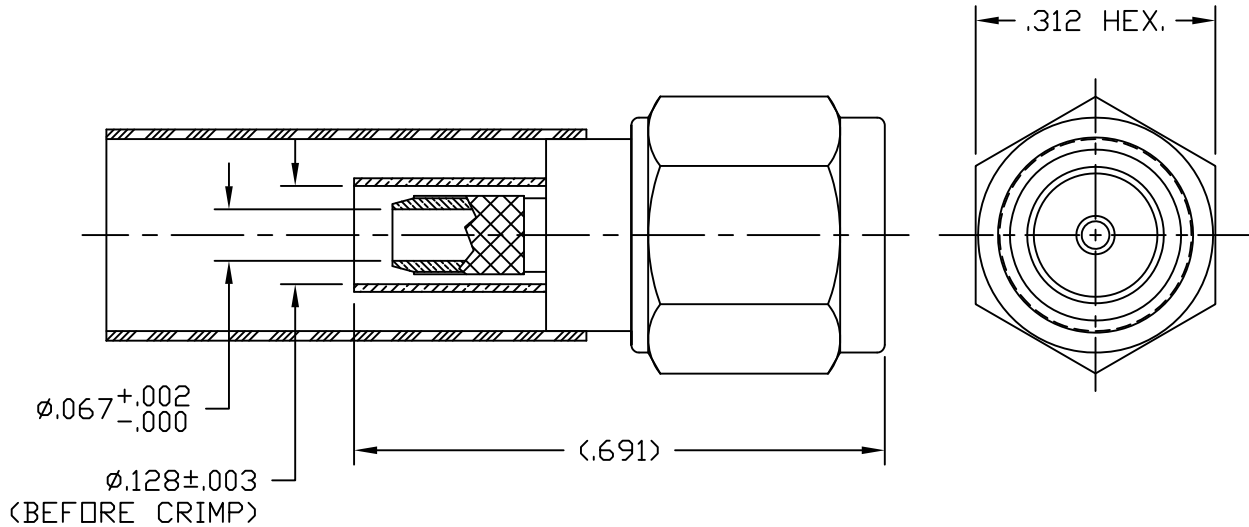

**NOTES:**

- ASSEMBLED CONNECTOR INTERFACE IS DESIGNED IN ACCORDANCE WITH MIL-STD-348.
- MATERIAL: BODY & HEX COUPLING NUT- CORROSION RESISTANT STEEL PER ASTM A582.  
CONTACT - BERYLLIUM COPPER PER ASTM B196.  
INSULATOR - TEFLON PER ASTM D1710  
GASKET - SILICONE RUBBER PER ZZ-R-765  
SHRINK SLEEVE - SHRINKABLE POLYOLEFIN PER MIL-I-23053/5  
FERRULE - D.H.P. COPPER CDA ALLOY 122
- FINISHES: BODY & HEX COUPLING NUT - PASSIVATE PER QQ-P-35  
CONTACT - GOLD PLATE PER MIL-G-45204  
FERRULE - SULFAMATE NICKEL PLATE
- CONTACT PIN IS SOLDERED.
- CRIMP THE FERRULE TO .128" HEX.

MATERIAL:	UNLESS OTHERWISE SPECIFIED		DFTM. J. C. L.	TIMES MICROWAVE SYSTEMS	
	ALL DIMENSIONS ARE IN INCHES MACHINED SURFACES FINISH N/A RMS MAX. REMOVE ALL BURRS .005 MAX. BREAK MACHINE CORNERS .005 MAX. FILLET R. TOLERANCES ON DECIMALS . XX ± .03 . XXX ± .005 ANGLES ± 1° FRACTIONS ± 1/32		DATE 8/20/03		
USED ON: A			CHKD. J. C. L.	<b>TC-100-SM</b> SMA MALE FOR LMR100 CABLE	
			DATE 8/20/03		
SCALE: N/A	DWG. SIZE A	DO NOT SCALE DRAWING	CODE IDENT 68999	APPD. J. C. L.	SHEET 1 of 1   SD3190-1551   REV B
			DATE 8/20/03		

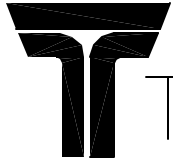

# TIMES MICROWAVE SYSTEMS

358 Hall Avenue/P.O. Box 5039  
Wallingford, CT 06492-5039  
Tel: 203-949-8400  
FAX: 203-949-8423  
1-800-TMS-COAX  
www.timesmicrowave.com

## INSTALLATION INSTRUCTIONS TC-100-SM (TIMES 3190-1551) (Cable Types: LMR-100)

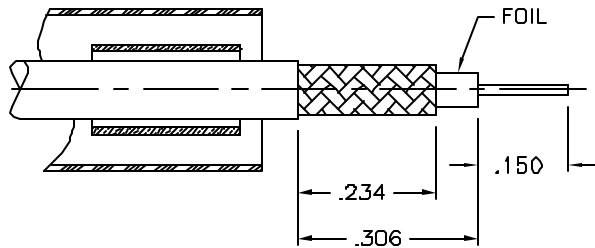
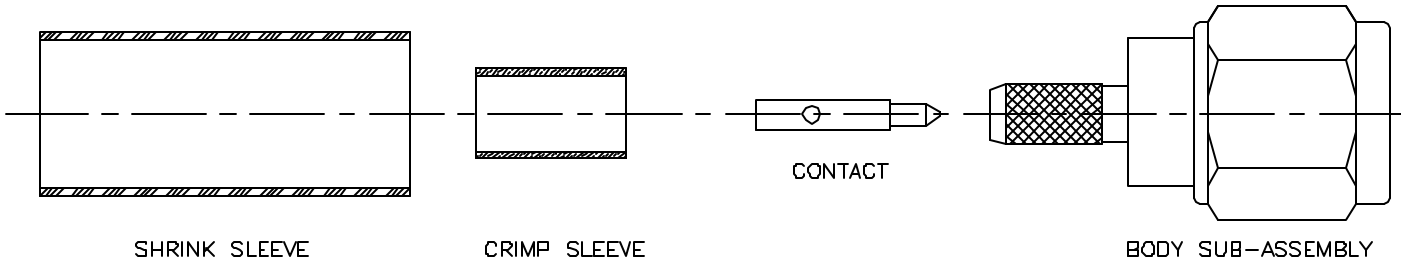

- 1) A. Trim cable to dimensions shown. Slide shrink sleeve & crimp sleeve back onto cable.  
B. Remove any residual plastic from the center conductor and deburr center conductor using a fine file.

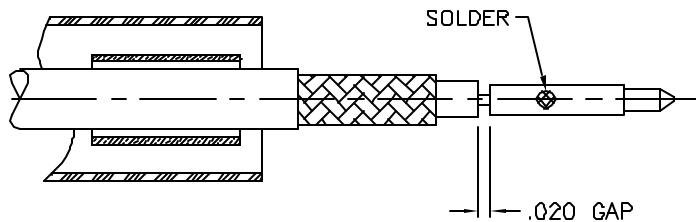

- 2) A. Slide contact onto center conductor leaving a .020 gap as shown and solder to center conductor. Use minimal heat to minimize melting of foam dielectric. Inspect to be sure aluminum foil is not touching center contact.

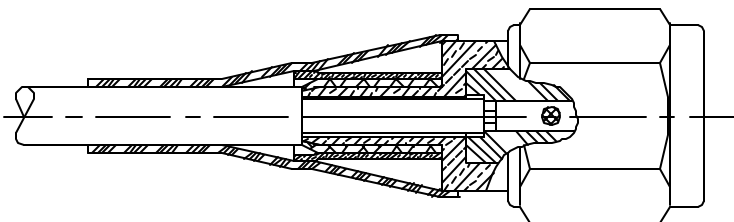

- 3) A. Insert cable into connector until fully seated, with all braid wires on the outside of connector body and aluminum tape inside connector body.  
B. Slide crimp sleeve forward and crimp as close as possible to body using a .128" hex die. Use Times HX-4 crimp tool or equivalent. Do not crimp rear of crimp sleeve.  
C. Heat shrink weather seal over rear of connector body and down onto cable jacket using hot air gun.

Flexible RG174 Coax Cable Single  
Shielded with Black PVC Jacket

RF Cables  
Technical Data Sheet

### Times Microwave Systems Coax Cable Specification

#### Configuration

- Flexible Cable
- 1 Shield(s)

#### Electrical Specifications

Description	Minimum	Typical	Maximum	Units
Frequency Range	DC		1,000	MHz
Impedance		50		Ohms
Velocity of Propagation		66		%
Nominal Capacitance		31.08 [101.97]		pF/ft [pF/m]

#### Performance by Frequency Band

Description	F1	F2	F3	F4	F5	Units
Frequency	100	400	1,000			MHz
Attenuation, Typ	8.4	27.56	32			dB/100ft
	27.56	90.42	104.99			dB/100m

#### Mechanical Specifications

Diameter	0.11 in [2.79 mm]
Weight	0.009 lbs/ft [0.01 Kg/m]

#### Construction Specifications

Description	Material and Plating	Diameter
Inner Conductor	Copper Clad Steel, 7 Strands	0.019 in [0.48 mm]
Conductor Type	Stranded	
Dielectric	PE	0.06 in [1.52 mm]
First Shield	Tinned Copper Braid	0.078 in [1.98 mm]

Click the following link (or enter part number in "SEARCH" on website) to obtain additional part information including price, inventory and certifications: [Flexible RG174 Coax Cable Single Shielded with Black PVC Jacket RG174A/U](#)

Flexible RG174 Coax Cable Single  
Shielded with Black PVC Jacket

RF Cables  
Technical Data Sheet

Jacket	PVC, Black	0.11 in [2.79 mm]
--------	------------	-------------------

**Environmental Specifications**

**Temperature**

Operating Range -40 to +80 deg C

**Compliance Certifications** (see [product page](#) for current document)

**Plotted and Other Data**

Notes:

Flexible RG174 Coax Cable Single Shielded with Black PVC Jacket from Pasternack Enterprises has same day shipment for domestic and International orders. Our RF, microwave and millimeter wave products maintain a 99.4% availability and are part of the broadest selection in the industry.

Click the following link (or enter part number in "SEARCH" on website) to obtain additional part information including price, inventory and certifications: [Flexible RG174 Coax Cable Single Shielded with Black PVC Jacket RG174A/U](#)

URL: <https://www.pasternack.com/flexible-0.100-rg174-50-ohm-coax-cable-pvc-jacket-rg174a-u-p.aspx>

The information contained in this document is accurate to the best of our knowledge and representative of the part described herein. It may be necessary to make modifications to the part and/or the documentation of the part, in order to implement improvements. Pasternack reserves the right to make such changes as required. Unless otherwise stated, all specifications are nominal. Pasternack does not make any representation or warranty regarding the suitability of the part described herein for any particular purpose, and Pasternack does not assume any liability arising out of the use of any part or documentation.

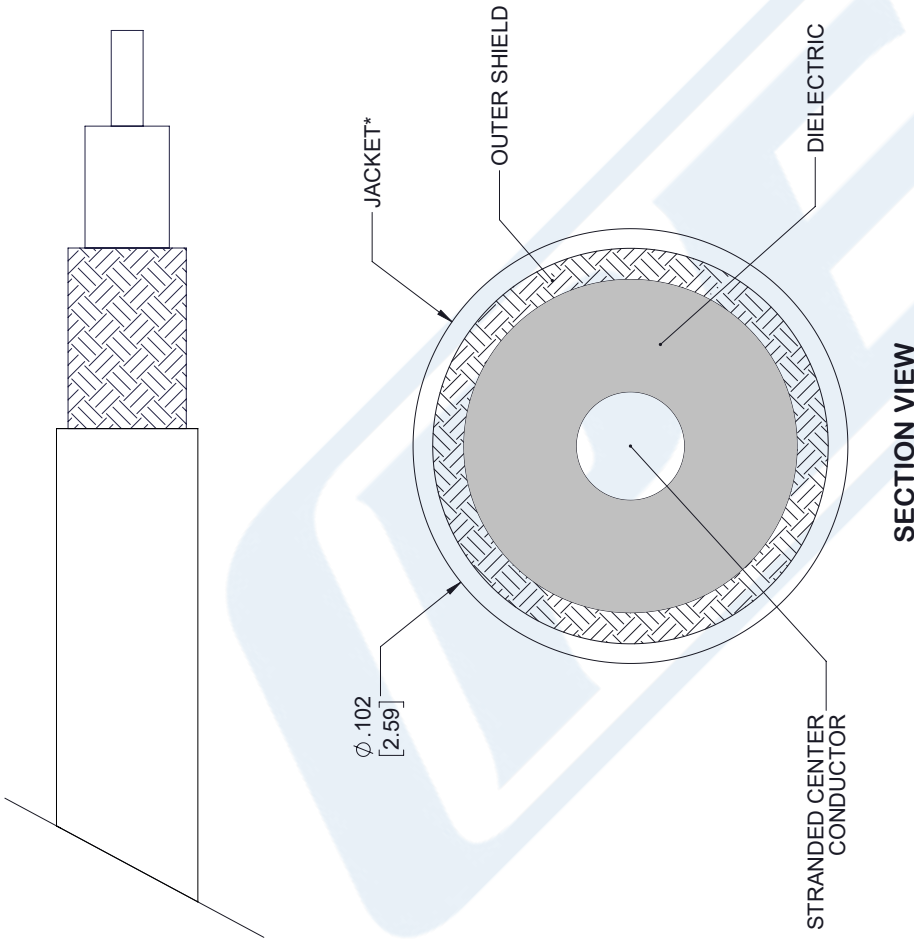

**NOTE:**

\*STANDARD TOLERANCES APPLY ONLY TO DIMENSIONS IN INCHES

STANDARD TOLERANCES
.X ±0.2
.XX ±0.01
.XXX ±0.005



Pasternack Enterprises, Inc.  
 P.O. Box 16759 | Irvine | CA | 92623  
**Phone:** (949) 261-1920 | **Fax:** (949) 261-7451  
**Website:** www.pasternack.com | **E-Mail:** sales@pasternack.com

DWG TITLE

RG174A/U

NOTES:  
 1. UNLESS OTHERWISE SPECIFIED ALL DIMENSIONS ARE NOMINAL.  
 2. ALL SPECIFICATIONS ARE SUBJECT TO CHANGE WITHOUT NOTICE AT ANY TIME  
 3. DIMENSIONS ARE IN INCHES [mm].

CAGE CODE 53919

CAD FILE 05/25/18

SCALE N/A

SIZE A

7361