



## BNC Male Connector Clamp/Solder Attachment for RG58, RG55, RG141, RG142, RG223, RG400, RG303, PE-C195, PE-P195, LMR-195

### RF Connectors Technical Data Sheet

PE4023

#### Configuration

- BNC Male Connector
- MIL-STD-348A
- 50 Ohms
- Straight Body Geometry
- RG58, RG55, RG141, RG142, RG223, RG400, RG303, PE-C195, PE-P195, LMR-195 Interface Type
- Clamp/Solder Attachment

#### Features

- Max. Operating Frequency 4 GHz
- Good VSWR of 1.5:1
- Gold Plated Brass Contact
- 30 µin minimum contact plating

#### Applications

- General Purpose Test
- Custom Cable Assemblies

#### Description

Pasternack's PE4023 BNC male connector with clamp/solder attachment for RG58, RG55, RG141, RG142, RG223, RG400, RG303, PE-C195, PE-P195 and LMR-195 is part of our full line of RF components available for same-day shipping. Our BNC male connector operates up to a maximum frequency of 4 GHz and offers good VSWR of 1.5:1.

Our BNC male connector PE4023 datasheet specifications and drawing with dimensions are shown below in this PDF. Pasternack's broad catalog of RF, microwave and millimeter wave connectors allows designers to configure and customize their signal connections however they like. Whether the need is to provide an I/O for a board design, or simply create a custom cable assembly configuration, Pasternack has the right connector for the job. Pasternack can also expertly build your custom cable assemblies for you and ship same-day.

#### Electrical Specifications

Description	Minimum	Typical	Maximum	Units
Frequency Range	DC		4	GHz
VSWR			1.5:1	
Operating Voltage (AC)			500	Vrms
Dielectric Withstanding Voltage (AC)			1,500	Vrms

#### Mechanical Specifications

##### Size

Length	1.09 in [27.69 mm]
Width/Dia.	0.571 in [14.50 mm]
Weight	0.038 lbs [17.24 g]

Click the following link (or enter part number in "SEARCH" on website) to obtain additional part information including price, inventory and certifications: [BNC Male Connector Clamp/Solder Attachment for RG58, RG55, RG141, RG142, RG223, RG400, RG303, PE-C195, PE-P195, LMR-195 PE4023](#)



BNC Male Connector Clamp/Solder Attachment  
 for RG58, RG55, RG141, RG142, RG223, RG400,  
 RG303, PE-C195, PE-P195, LMR-195

## RF Connectors Technical Data Sheet

PE4023

### Material Specifications

Description	Material	Plating
Contact	Brass	Gold 30 µin minimum
Insulation	PTFE	
Body	Brass	Nickel 100 µin minimum
Coupling Nut	Brass	Nickel 100 µin minimum

### Environmental Specifications

#### Temperature

Operating Range

-65 to +165 deg C

**Compliance Certifications** (see [product page](#) for current document)

### Plotted and Other Data

Notes:

BNC Male Connector Clamp/Solder Attachment for RG58, RG55, RG141, RG142, RG223, RG400, RG303, PE-C195, PE-P195, LMR-195 from Pasternack Enterprises has same day shipment for domestic and International orders. Our RF, microwave and millimeter wave products maintain a 99% availability and are part of the broadest selection in the industry.

Click the following link (or enter part number in "SEARCH" on website) to obtain additional part information including price, inventory and certifications: [BNC Male Connector Clamp/Solder Attachment for RG58, RG55, RG141, RG142, RG223, RG400, RG303, PE-C195, PE-P195, LMR-195 PE4023](#)

URL: <https://www.pasternack.com/bnc-male-standard-rg58-rg55-rg141-rg142-rg223-rg400-connector-pe4023-p.aspx>

The information contained in this document is accurate to the best of our knowledge and representative of the part described herein. It may be necessary to make modifications to the part and/or the documentation of the part, in order to implement improvements. Pasternack reserves the right to make such changes as required. Unless otherwise stated, all specifications are nominal. Pasternack does not make any representation or warranty regarding the suitability of the part described herein for any particular purpose, and Pasternack does not assume any liability arising out of the use of any part or documentation.

# PE4023 CAD Drawing

BNC Male Connector Clamp/Solder Attachment for RG58, RG55, RG141, RG142, RG223, RG400, RG303, PE-C195, PE-P195, LMR-195

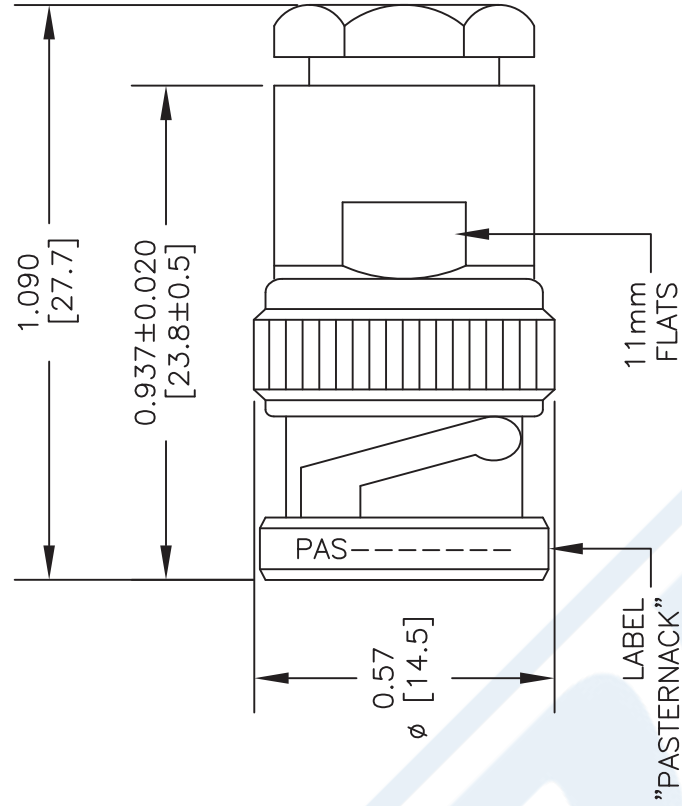

STANDARD TOLERANCES	
.X	±0.2
.XX	±0.1
.XXX	±0.05

\*STANDARD TOLERANCES APPLY ONLY TO DIMENSIONS IN INCHES

NOTES:  
 1. UNLESS OTHERWISE SPECIFIED ALL DIMENSIONS ARE NOMINAL.  
 2. ALL SPECIFICATIONS ARE SUBJECT TO CHANGE WITHOUT NOTICE AT ANY TIME.  
 3. DIMENSIONS ARE IN INCHES [mm].

## ASSEMBLY PROCEDURES

1. SLIDE CLAMP NUT (1), WASHER (2) & GASKET (3) OVER CABLE AS SHOWN.

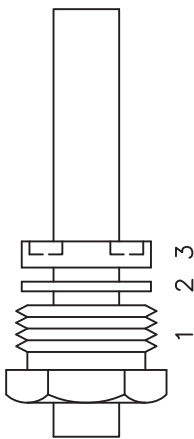

2. TRIM PER DIMENSIONS.

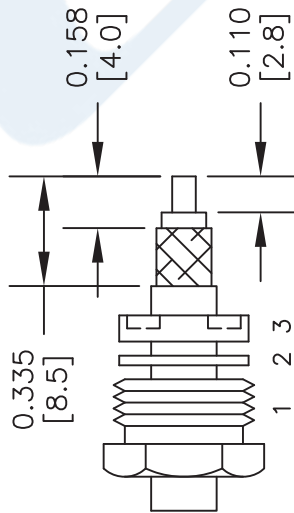

3. a) SLIDE BRAID CLAMP OVER BRAID UNTIL IT STOPS ON CABLE JACKET.  
 b) FLAIR BRAID AS SHOWN.

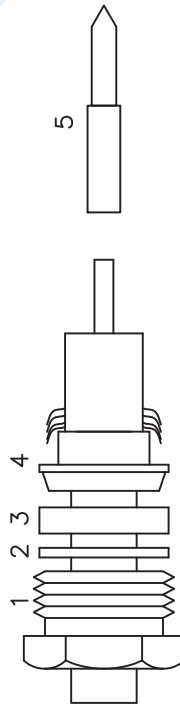

4. INSTALL CONTACT BY SOLDERING TO CABLE CENTER CONDUCTOR LEAVING NO GAPS (5).

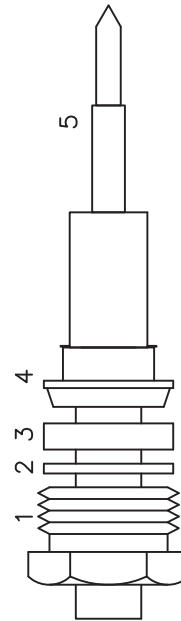

5. REMOVE EXCESS SOLDER. INSERT ASSEMBLY INTO CONNECTOR BODY AND TIGHTEN NUT.

DWG TITLE

**PE4023**

**PE PASTERNAK**  
 THE ENGINEER'S RF SOURCE

Pasternack Enterprises, Inc.  
 P.O. Box 16759 | Irvine | CA | 92623  
 Phone: (949) 261-1920 | Fax: (949) 261-7451  
 Website: www.pasternack.com | E-Mail: sales@pasternack.com

FSCM NO. 53919

CAD FILE 040116

SCALE N/A

SIZE A

3045



## BNC Male Connector Clamp/Solder Attachment for RG58, RG55, RG141, RG142, RG223, RG400, RG303, PE-C195, PE-P195, LMR-195

### RF Connectors Technical Data Sheet

PE4023

#### Configuration

- BNC Male Connector
- MIL-STD-348A
- 50 Ohms
- Straight Body Geometry
- RG58, RG55, RG141, RG142, RG223, RG400, RG303, PE-C195, PE-P195, LMR-195 Interface Type
- Clamp/Solder Attachment

#### Features

- Max. Operating Frequency 4 GHz
- Good VSWR of 1.5:1
- Gold Plated Brass Contact
- 30 µin minimum contact plating

#### Applications

- General Purpose Test
- Custom Cable Assemblies

#### Description

Pasternack's PE4023 BNC male connector with clamp/solder attachment for RG58, RG55, RG141, RG142, RG223, RG400, RG303, PE-C195, PE-P195 and LMR-195 is part of our full line of RF components available for same-day shipping. Our BNC male connector operates up to a maximum frequency of 4 GHz and offers good VSWR of 1.5:1.

Our BNC male connector PE4023 datasheet specifications and drawing with dimensions are shown below in this PDF. Pasternack's broad catalog of RF, microwave and millimeter wave connectors allows designers to configure and customize their signal connections however they like. Whether the need is to provide an I/O for a board design, or simply create a custom cable assembly configuration, Pasternack has the right connector for the job. Pasternack can also expertly build your custom cable assemblies for you and ship same-day.

#### Electrical Specifications

Description	Minimum	Typical	Maximum	Units
Frequency Range	DC		4	GHz
VSWR			1.5:1	
Operating Voltage (AC)			500	Vrms
Dielectric Withstanding Voltage (AC)			1,500	Vrms

#### Mechanical Specifications

##### Size

Length	1.09 in [27.69 mm]
Width/Dia.	0.571 in [14.50 mm]
Weight	0.038 lbs [17.24 g]

Click the following link (or enter part number in "SEARCH" on website) to obtain additional part information including price, inventory and certifications: [BNC Male Connector Clamp/Solder Attachment for RG58, RG55, RG141, RG142, RG223, RG400, RG303, PE-C195, PE-P195, LMR-195 PE4023](#)



BNC Male Connector Clamp/Solder Attachment  
 for RG58, RG55, RG141, RG142, RG223, RG400,  
 RG303, PE-C195, PE-P195, LMR-195

## RF Connectors Technical Data Sheet

PE4023

### Material Specifications

Description	Material	Plating
Contact	Brass	Gold 30 µin minimum
Insulation	PTFE	
Body	Brass	Nickel 100 µin minimum
Coupling Nut	Brass	Nickel 100 µin minimum

### Environmental Specifications

#### Temperature

Operating Range

-65 to +165 deg C

**Compliance Certifications** (see [product page](#) for current document)

### Plotted and Other Data

Notes:

BNC Male Connector Clamp/Solder Attachment for RG58, RG55, RG141, RG142, RG223, RG400, RG303, PE-C195, PE-P195, LMR-195 from Pasternack Enterprises has same day shipment for domestic and International orders. Our RF, microwave and millimeter wave products maintain a 99% availability and are part of the broadest selection in the industry.

Click the following link (or enter part number in "SEARCH" on website) to obtain additional part information including price, inventory and certifications: [BNC Male Connector Clamp/Solder Attachment for RG58, RG55, RG141, RG142, RG223, RG400, RG303, PE-C195, PE-P195, LMR-195 PE4023](#)

URL: <https://www.pasternack.com/bnc-male-standard-rg58-rg55-rg141-rg142-rg223-rg400-connector-pe4023-p.aspx>

The information contained in this document is accurate to the best of our knowledge and representative of the part described herein. It may be necessary to make modifications to the part and/or the documentation of the part, in order to implement improvements. Pasternack reserves the right to make such changes as required. Unless otherwise stated, all specifications are nominal. Pasternack does not make any representation or warranty regarding the suitability of the part described herein for any particular purpose, and Pasternack does not assume any liability arising out of the use of any part or documentation.

# PE4023 CAD Drawing

BNC Male Connector Clamp/Solder Attachment for RG58, RG55, RG141, RG142, RG223, RG400, RG303, PE-C195, PE-P195, LMR-195



### STANDARD TOLERANCES

.X	±0.2
.XX	±0.1
.XXX	±0.05

\*STANDARD TOLERANCES APPLY ONLY TO DIMENSIONS IN INCHES

### NOTES:

1. UNLESS OTHERWISE SPECIFIED ALL DIMENSIONS ARE NOMINAL.
2. ALL SPECIFICATIONS ARE SUBJECT TO CHANGE WITHOUT NOTICE AT ANY TIME.
3. DIMENSIONS ARE IN INCHES [mm].

### ASSEMBLY PROCEDURES

1. SLIDE CLAMP NUT (1), WASHER (2) & GASKET (3) OVER CABLE AS SHOWN.

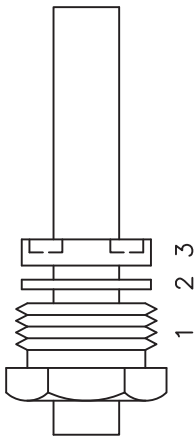

2. TRIM PER DIMENSIONS.

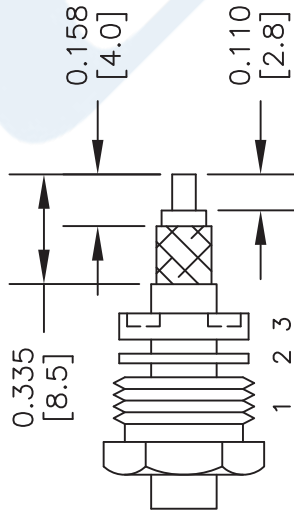

3. a) SLIDE BRAID CLAMP OVER BRAID UNTIL IT STOPS ON CABLE JACKET.  
b) FLAIR BRAID AS SHOWN.

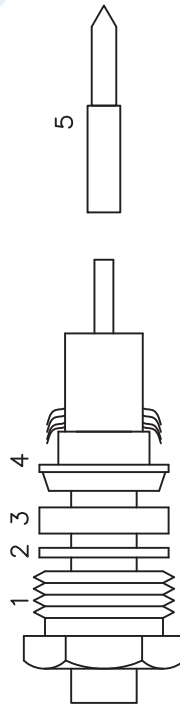

4. INSTALL CONTACT BY SOLDERING TO CABLE CENTER CONDUCTOR LEAVING NO GAPS (5).

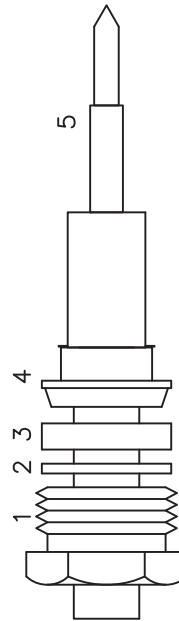

5. REMOVE EXCESS SOLDER. INSERT ASSEMBLY INTO CONNECTOR BODY AND TIGHTEN NUT.

DWG TITLE

**PE4023**

**PE PASTERNAK**  
THE ENGINEER'S RF SOURCE

Pasternack Enterprises, Inc.  
P.O. Box 16759 | Irvine | CA | 92623  
Phone: (949) 261-1920 | Fax: (949) 261-7451  
Website: www.pasternack.com | E-Mail: sales@pasternack.com

FSCM NO. 53919

CAD FILE 040116

SCALE N/A

SIZE A

3045

**TECHNICAL DATA SHEET**
**RG142B/U**

Flexible RG142 Coax Cable Double Shielded with Tan FEP Jacket

**Configuration**

Inner Conductor Material and Plating	Copper Clad Steel, Silver
Dielectric Type	PTFE
Shield Materials	Silver Plated Copper Braid, Silver Plated Copper Braid
Jacket Material and Color	FEP, Tan

**Electrical Specifications**

Impedance, Ohms	50
Velocity of Propagation, %	69.2
Maximum Operating Frequency, GHz	8
RF Shielding, dB	90
Capacitance, pF/ft [pF/m]	29.4 [96.46]
Maximum Operating Voltage, Volts	1,900

**Electrical Specifications by Frequency**
**Frequency 1**

Frequency, MHz	100
Attenuation, dB/100ft [dB/100m]	3.9 [12.8]

**Frequency 2**

Frequency, MHz	1000
Attenuation, dB/100ft [dB/100m]	13 [42.65]

**Frequency 3**

Frequency, GHz	3
Attenuation, dB/100ft [dB/100m]	23.8 [78.08]

**Frequency 4**

Frequency, GHz	5
Attenuation, dB/100ft [dB/100m]	36 [118.11]

**Mechanical Specifications**
**Temperature**

Operating Range, deg C	-55 to +200
------------------------	-------------

**Inner Conductor**

Number of Strands	1
Material	Copper Clad Steel
Plating	Silver
Diameter, in [mm]	0.037 [0.94]

Click the following link (or enter part number in "SEARCH" on website) to obtain additional part information including price, inventory and certifications: [Flexible RG142 Coax Cable Double Shielded with Tan FEP Jacket RG142B/U](#)

The information contained in this document is accurate to the best of our knowledge and representative of the part described herein. It may be necessary to make modifications to the part and/or the documentation of the part, in order to implement improvements. Pasternack reserves the right to make such changes as required. Unless otherwise stated, all specifications are nominal.



# TECHNICAL DATA SHEET RG142B/U

**Dielectric:**

Type	PTFE
Diameter, in [mm]	0.116 [2.95]

**Shield:**

Number of	2
Material 1	Silver Plated Copper Braid
Material 2	Silver Plated Copper Braid
Diameter, in [mm]	0.156 [3.96]

**Jacket:**

Material	FEP
Diameter, in [mm]	0.195 [4.95]
Color	Tan
One Time Minimum Bend Radius, in [mm]	0.984 [24.99]
Repeated Minimum Bend Radius, in [mm]	2 [50.8]
Weight, lbs/ft [Kg/m]	0.046 [0.07]

**Compliance Certifications** (visit [www.Pasternack.com](http://www.Pasternack.com) for current document)

RoHS Compliant	Yes
----------------	-----

**Plotted and Other Data**

Notes:	Values at 25 °C, sea level
--------	----------------------------

URL: <http://www.pasternack.com/flexible-0.195-rg142-50-ohm-coax-cable-fep-jacket-rg142b-u-p.aspx>

Flexible RG142 Coax Cable Double Shielded with Tan FEP Jacket from Pasternack Enterprises has same day shipment for domestic and International orders. Our RF, microwave and fiber optic products maintain a 99% availability and are part of the broadest selection in the industry.

The information contained in this document is accurate to the best of our knowledge and representative of the part described herein. It may be necessary to make modifications to the part and/or the documentation of the part, in order to implement improvements. Pasternack reserves the right to make such changes as required. Unless otherwise stated, all specifications are nominal.

# RG142B/U CAD Drawing

Flexible RG142 Coax Cable Double Shielded with Tan FEP Jacket



NOTES:  
 1. UNLESS OTHERWISE SPECIFIED ALL DIMENSIONS ARE NOMINAL.  
 2. ALL SPECIFICATIONS ARE SUBJECT TO CHANGE WITHOUT NOTICE AT ANY TIME.  
 3. DIMENSIONS ARE IN INCHES [mm].

DWG TITLE  
**RG142B/U**

FSCM NO. 53919

CAD FILE 022808-A

SCALE N/A

SIZE A

2233

**PE PASTERNAK®**  
 Pasternack Enterprises, Inc.  
 P.O. Box 16759 | Irvine | CA | 92623  
**Phone:** (949) 261-1920 | **Fax:** (949) 261-7451  
**Website:** www.pasternack.com | **E-Mail:** sales@pasternack.com