



SSMB Plug Right Angle Connector Crimp/Solder Attachment for RG174, RG179, RG316, RG188, PE-B100, PE-C100, 0.100 inch, LMR-100

## RF Connectors Technical Data Sheet

PE4334

### Configuration

- SSMB Plug Connector
- MIL-STD-348
- 50 Ohms
- Right Angle Body Geometry
- RG174, RG179, RG316, RG188, PE-B100, PE-C100, 0.100 inch, LMR-100 Interface Type
- Crimp/Solder Attachment

### Features

- Gold Plated Contact
- Contact plating according to MIL-G-45204

### Applications

- General Purpose Test
- Custom Cable Assemblies

### Description

Pasternack's PE4334 SSMB plug right angle connector with crimp/solder attachment for RG174, RG179, RG316, RG188, PE-B100, PE-C100, 0.100 inch and LMR-100 is part of our full line of RF components available for same-day shipping. Its right angle body geometry allows for easier connections in tight spaces.

Our SSMB plug right angle connector PE4334 datasheet specifications and drawing with dimensions are shown below in this PDF. Pasternack's broad catalog of RF, microwave and millimeter wave connectors allows designers to configure and customize their signal connections however they like. Whether the need is to provide an I/O for a board design, or simply create a custom cable assembly configuration, Pasternack has the right connector for the job. Pasternack can also expertly build your custom cable assemblies for you and ship same-day.

### Mechanical Specifications

#### Size

Length	0.475 in [12.07 mm]
Width/Dia.	0.188 in [4.78 mm]
Height	0.435 in [11.05 mm]
Weight	0.005 lbs [2.27 g]

#### Material Specifications

Description	Material	Plating
Contact		Gold MIL-G-45204
Insulation	PTFE	
Body	Brass	Gold MIL-G-45204

Click the following link (or enter part number in "SEARCH" on website) to obtain additional part information including price, inventory and certifications: [SSMB Plug Right Angle Connector Crimp/Solder Attachment for RG174, RG179, RG316, RG188, PE-B100, PE-C100, 0.100 inch, LMR-100 PE4334](#)



SSMB Plug Right Angle Connector Crimp/Solder Attachment for RG174, RG179, RG316, RG188, PE-B100, PE-C100, 0.100 inch, LMR-100

## RF Connectors Technical Data Sheet

PE4334

**Compliance Certifications** (see [product page](#) for current document)

### Plotted and Other Data

Notes:

SSMB Plug Right Angle Connector Crimp/Solder Attachment for RG174, RG179, RG316, RG188, PE-B100, PE-C100, 0.100 inch, LMR-100 from Pasternack Enterprises has same day shipment for domestic and International orders. Our RF, microwave and millimeter wave products maintain a 99% availability and are part of the broadest selection in the industry.

Click the following link (or enter part number in "SEARCH" on website) to obtain additional part information including price, inventory and certifications: [SSMB Plug Right Angle Connector Crimp/Solder Attachment for RG174, RG179, RG316, RG188, PE-B100, PE-C100, 0.100 inch, LMR-100 PE4334](#)

URL: <https://www.pasternack.com/ssmb-plug-standard-rg174-rg179-rg316-rg188-connector-pe4334-p.aspx>

The information contained in this document is accurate to the best of our knowledge and representative of the part described herein. It may be necessary to make modifications to the part and/or the documentation of the part, in order to implement improvements. Pasternack reserves the right to make such changes as required. Unless otherwise stated, all specifications are nominal. Pasternack does not make any representation or warranty regarding the suitability of the part described herein for any particular purpose, and Pasternack does not assume any liability arising out of the use of any part or documentation.

# PE4334 CAD Drawing

SSMB Plug Right Angle Connector Crimp/Solder Attachment for RG174, RG179, RG316, RG188, PE-B100, PE-C100, 0.100 inch, LMR-100

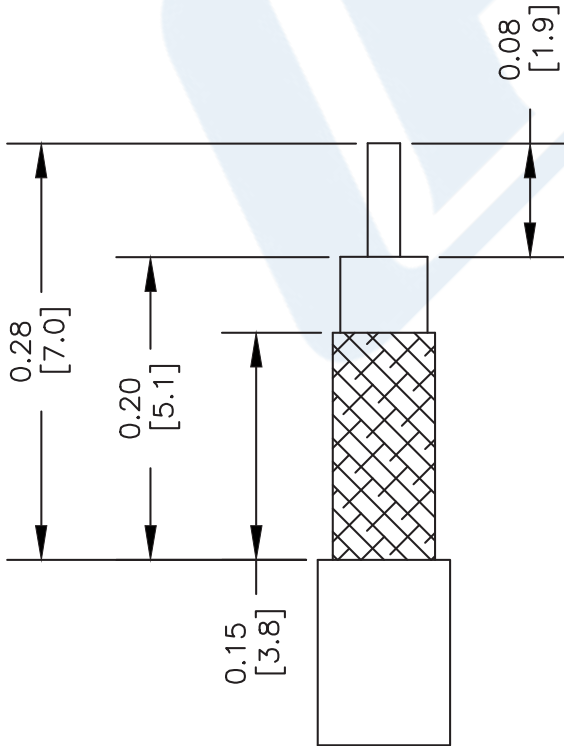

### STRIPPING DIMENSIONS

### ASSEMBLY PROCEDURES

1. STRIP CABLE AS SHOWN.
2. INSTALL CABLE INTO BODY OF CONNECTOR AND SOFT SOLDER CENTER CONDUCTOR IN PLACE.
3. SLIDE FERRULE OVER BRAID & SEAT AGAINST BODY. CRIMP FERRULE. PRESS CAP DOWN.

### CRIMP SIZE REQUIRED

FERRULE: .128" HEX CRIMP TOOL

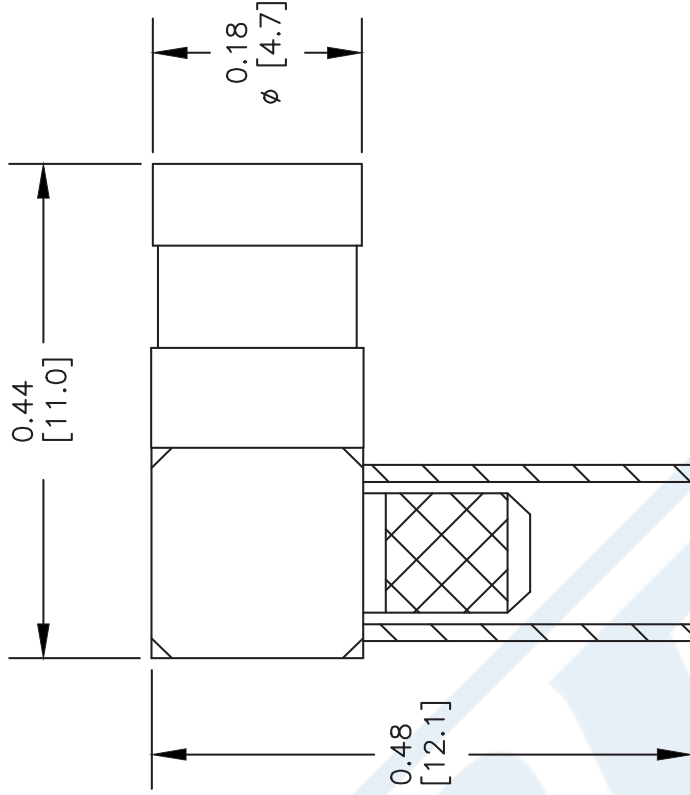

DWG TITLE

**PE4334**

NOTES:  
 1. UNLESS OTHERWISE SPECIFIED ALL DIMENSIONS ARE NOMINAL.  
 2. ALL SPECIFICATIONS ARE SUBJECT TO CHANGE WITHOUT NOTICE AT ANY TIME.  
 3. DIMENSIONS ARE IN INCHES [mm].  
 4. FITS MIL-C-17 AND EQUIVALENT CABLES.

REV. -

FSCM NO. 53919

CAD FILE 080405

SCALE N/A

SIZE A

2233



Pasternack Enterprises, Inc.  
 P.O. Box 16759 | Irvine | CA | 92623

Phone: (949) 261-1920 | Fax: (949) 261-7451

Website: [www.pasternack.com](http://www.pasternack.com) | E-Mail: [sales@pasternack.com](mailto:sales@pasternack.com)



SMA Female Connector Crimp/Solder Attachment for RG316, RG174, LMR-100, RG188, PE-B100, PE-C100, 0.100 inch

RF Connectors  
Technical Data Sheet

PE45137

**Configuration**

- SMA Female Connector
- MIL-STD-348A
- 50 Ohms
- Straight Body Geometry
- Connector Interface Types: RG316, RG174, LMR-100, RG188, PE-B100, PE-C100, 0.100 inch

**Features**

- Max. Operating Frequency 6 GHz
- Good VSWR of 1.3:1
- Gold Plated Beryllium Copper Contact
- 50µ in. minimum contact plating

**Applications**

- General Purpose Test
- Custom Cable Assemblies

**Description**

Pasternack's PE45137 SMA female connector with crimp/solder attachment for RG316, RG174, LMR-100, RG188, PE-B100, PE-C100 and 0.100 inch is part of our full line of RF components available for same-day shipping. Our SMA female connector operates up to a maximum frequency of 6 GHz and offers good VSWR of 1.3:1.

Our SMA female connector PE45137 datasheet specifications and drawing with dimensions are shown below in this PDF. Pasternack's broad catalog of RF, microwave and millimeter wave connectors allows designers to configure and customize their signal connections however they like. Whether the need is to provide an I/O for a board design, or simply create a custom cable assembly configuration, Pasternack has the right connector for the job. Pasternack can also expertly build your custom cable assemblies for you and ship same-day.

**Electrical Specifications**

Description	Minimum	Typical	Maximum	Units
Frequency Range	DC		6	GHz
VSWR			1.3:1	
Operating Voltage (AC)			335	Vrms

**Performance by Frequency**

Description	F1	F2	F3	F4	F5	Units
Frequency Range	DC to 3					GHz
VSWR, Max	1.21:1					

**Mechanical Specifications**

Size	
Length	0.591 in [15.01 mm]
Width/Dia.	0.25 in [6.35 mm]

Click the following link (or enter part number in "SEARCH" on website) to obtain additional part information including price, inventory and certifications: [SMA Female Connector Crimp/Solder Attachment for RG316, RG174, LMR-100, RG188, PE-B100, PE-C100, 0.100 inch PE45137](#)



SMA Female Connector Crimp/Solder Attachment for RG316, RG174, LMR-100, RG188, PE-B100, PE-C100, 0.100 inch

RF Connectors  
Technical Data Sheet

PE45137

Weight 0.01 lbs [4.54 g]

**Material Specifications**

Description	Material	Plating
Contact	Beryllium Copper	Gold 50μ in. minimum
Insulation	Teflon	
Outer Conductor	Brass	Gold 3μ in. minimum
Body	Brass	Gold 3μ in. minimum

**Environmental Specifications**

**Temperature**

Operating Range -65 to +165 deg C

**Compliance Certifications** (see [product page](#) for current document)

**Plotted and Other Data**

Notes:

SMA Female Connector Crimp/Solder Attachment for RG316, RG174, LMR-100, RG188, PE-B100, PE-C100, 0.100 inch from Pasternack Enterprises has same day shipment for domestic and International orders. Our RF, microwave and millimeter wave products maintain a 99.4% availability and are part of the broadest selection in the industry.

Click the following link (or enter part number in "SEARCH" on website) to obtain additional part information including price, inventory and certifications: [SMA Female Connector Crimp/Solder Attachment for RG316, RG174, LMR-100, RG188, PE-B100, PE-C100, 0.100 inch PE45137](#)

URL: <https://www.pasternack.com/sma-female-rg316-rg174-lmr-100-connector-pe45137-p.aspx>

The information contained in this document is accurate to the best of our knowledge and representative of the part described herein. It may be necessary to make modifications to the part and/or the documentation of the part, in order to implement improvements. Pasternack reserves the right to make such changes as required. Unless otherwise stated, all specifications are nominal. Pasternack does not make any representation or warranty regarding the suitability of the part described herein for any particular purpose, and Pasternack does not assume any liability arising out of the use of any part or documentation.

# PE45137 CAD Drawing

SMA Female Connector Crimp/Solder Attachment for RG316, RG174, LMR-100, RG188, PE-B100, PE-C100, 0.100 inch

REVISIONS			
REV.	DESCRIPTION	DATE	APPROVED
A	PCR PE45137 20200921	10/23/20	SRAUTUS

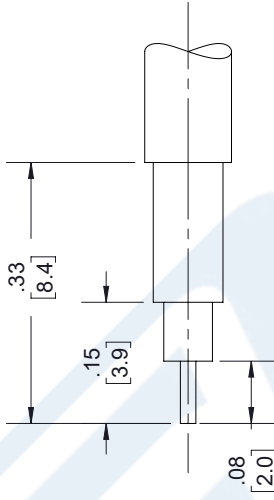
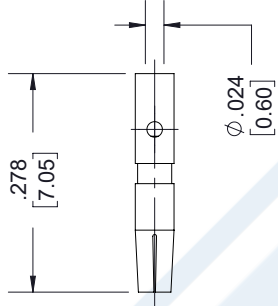
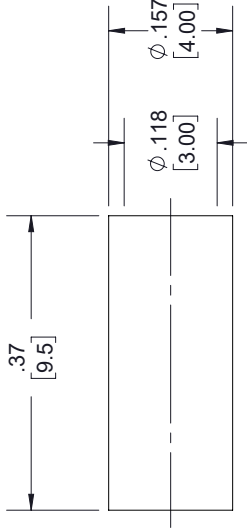
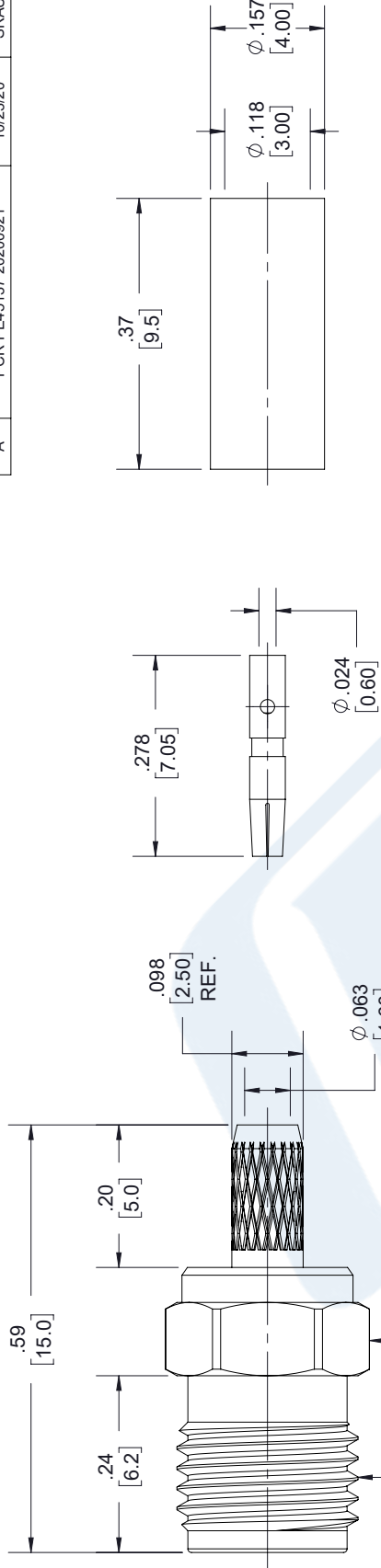

## STRIPPING DIMENSIONS

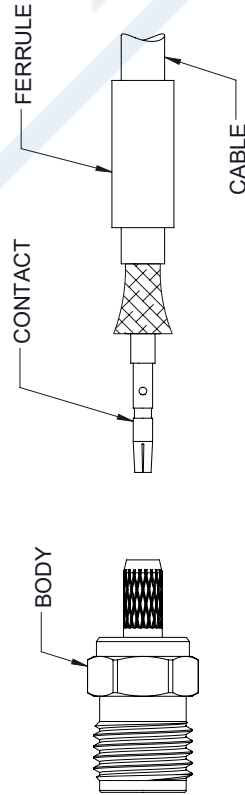

## ASSEMBLY PROCEDURES

1. STRIP CABLE TO THE DIMENSIONS SHOWN, DO NOT NICK CENTER CONDUCTOR OR BRAID.
2. SLIDE FERRULE ONTO CABLE.
3. PUSH CENTER CONDUCTOR FULLY INTO CONTACT AND SOLDER, REMOVE ANY EXCESS SOLDER.
4. FLARE BRAID AND INSERT CONTACT INTO THE BODY UNTIL IT SEATS.
5. SLIDE FERRULE OVER BRAID AND CRIMP WITH .138" [3.5] HEX CRIMP TOOL.

UNLESS OTHERWISE SPECIFIED LEADING DIMENSIONS ARE IN INCHES DIMENSIONS IN [ ] ARE MILLIMETERS	
.X = ±.2 [5.08]	FRACTIONS ± 1/32
.XX = ±.02 [.51]	ANGLES ± 1°
.XXX = ±.005 [.13]	CABLE LENGTH (L) TOLERANCES:
L ≤ 12 [305] = +1 [25] / -0	
12 [305] < L ≤ 60 [1524] = +2 [51] / -0	
60 [1524] < L ≤ 120 [3048] = +4 [102] / -0	
120 [3048] < L ≤ 300 [7620] = +6 [152] / -0	
300 [7620] < L = +5%L / -0	
ALL DIMENSIONS SHOWN ARE FOR REFERENCE ONLY.	



Pasternack Enterprises, Inc.  
P.O. Box 16759, Irvine, CA 92623.  
Phone: 1.949.261.1920 | 1.866.727.8376  
Fax: 1.949.261.7451  
Website: www.pasternack.com  
E-mail: sales@pasternack.com

THIRD-ANGLE PROJECTION	
THE INFORMATION AND DESIGN ARE PROPERTY OF PASTERNAK CORPORATION ALL RIGHTS RESERVED.	
SHEET 1	OF 1
SCALE	N/A

SIZE	CAGE CODE	DRAWN BY	ITEM NO.	REV
A	53919	SLI	PE45137	A

## Flexible RG316 Coax Cable Single Shielded with Tan FEP Jacket

### RF Cables Technical Data Sheet

RG316/U

#### Configuration

- Flexible Cable
- 1 Shield(s)

#### Features

- High Flexibility
- FEP Jacket
- Velocity of Propagation 69%

#### Applications

- General Purpose
- Antenna Feeds
- Communication Systems
- Wireless Systems
- Indoor / Outdoor Uses
- High Temperature Applications
- High Flexibility Applications
- Jumper Cable Assemblies

#### Description

Flexible coaxial cable are ideal for applications where tight bends and continual flexure are required. Pasternack's RG316/U is a single shielded flexible coax cable with FEP jacket and compatible with a wide selection of connector types. This RG316/U coaxial cable has a stranded inner conductor for better flexibility and operates up to 3 GHz. The FEP jacket of this RG316/U coax cable makes it suitable for indoor/outdoor uses and high temperature applications. RG316/U datasheet specifications and outline drawing for this flexible cable are shown in the PDF below.

Pasternack carries a wide range of cables ready to ship same day to fit your needs. They are available in corrugated, flexible, formable or semi-rigid versions with different constructions of conductor materials, dielectric materials, shielding configurations and jacket materials. Our cables are designed to fit a wide range of performance criteria including attenuation, operating temperature, environmental factor, and power capability.

#### Electrical Specifications

Description	Minimum	Typical	Maximum	Units
Frequency Range	DC		3	GHz
Impedance		50		Ohms
Velocity of Propagation		69		%
Operating Voltage (AC)			900	Vrms
Dielectric Withstanding Voltage (AC)			2,000	Vrms
Jacket Spark			2,000	Vrms
Nominal Capacitance			32 [104.99]	[pF/m]

Click the following link (or enter part number in "SEARCH" on website) to obtain additional part information including price, inventory and certifications: [Flexible RG316 Coax Cable Single Shielded with Tan FEP Jacket RG316/U](#)

## Flexible RG316 Coax Cable Single Shielded with Tan FEP Jacket

### RF Cables Technical Data Sheet

RG316/U

#### Performance by Frequency Band

Description	F1	F2	F3	F4	F5	Units
Frequency	0.05	0.1	0.4	1	3	GHz
Attenuation, Typ	7.5	11	21	38	58	dB/100ft
	24.61	36.09	68.9	124.67	190.29	dB/100m

#### Mechanical Specifications

Diameter	0.102 in [2.59 mm]
Weight	0.01 lbs/ft [0.01 Kg/m]

#### Construction Specifications

Description	Material and Plating	Diameter
Inner Conductor	Copper Clad Steel, Silver7	0.02 in 0.51 mm
Conductor Type	Stranded	
Dielectric	PTFE	0.06 in 1.52 mm
First Shield	Silver Plated Copper Braid 95% coverage	0.081 in 2.06 mm
Jacket	FEP, Tan	0.102 in [2.59 mm]

#### Environmental Specifications

Temperature Operating Range	-55 to +200 deg C
--------------------------------	-------------------

Click the following link (or enter part number in "SEARCH" on website) to obtain additional part information including price, inventory and certifications: [Flexible RG316 Coax Cable Single Shielded with Tan FEP Jacket RG316/U](#)

## Flexible RG316 Coax Cable Single Shielded with Tan FEP Jacket

### RF Cables Technical Data Sheet

RG316/U

**Compliance Certifications** (see [product page](#) for current document)

#### Plotted and Other Data

Notes:

Flexible RG316 Coax Cable Single Shielded with Tan FEP Jacket from Pasternack Enterprises has same day shipment for domestic and International orders. Our RF, microwave and millimeter wave products maintain a 99.4% availability and are part of the broadest selection in the industry.

Click the following link (or enter part number in "SEARCH" on website) to obtain additional part information including price, inventory and certifications: [Flexible RG316 Coax Cable Single Shielded with Tan FEP Jacket RG316/U](#)

URL: <https://www.pasternack.com/flexible-rg316u-fep-jacket-silver-plated-copper-braid-outer-conductor-single-shielded-rg316-u-p.aspx>

The information contained in this document is accurate to the best of our knowledge and representative of the part described herein. It may be necessary to make modifications to the part and/or the documentation of the part, in order to implement improvements. Pasternack reserves the right to make such changes as required. Unless otherwise stated, all specifications are nominal. Pasternack does not make any representation or warranty regarding the suitability of the part described herein for any particular purpose, and Pasternack does not assume any liability arising out of the use of any part or documentation.

# RG316/U CAD Drawing

Flexible RG316 Coax Cable Single Shielded with Tan FEP Jacket



NOTES:  
1. UNLESS OTHERWISE SPECIFIED ALL DIMENSIONS ARE NOMINAL.  
2. ALL SPECIFICATIONS ARE SUBJECT TO CHANGE WITHOUT NOTICE AT ANY TIME.  
3. DIMENSIONS ARE IN INCHES (mm).

DWG TITLE

**RG316/U**

FSCM NO. 53919

CAD FILE

111716

SCALE N/A

SIZE A

41742



Pasternack Enterprises, Inc.  
P.O. Box 16759 | Irvine | CA | 92623  
Phone: (949) 261-1920 | Fax: (949) 261-7451  
Website: [www.pasternack.com](http://www.pasternack.com) | E-Mail: [sales@pasternack.com](mailto:sales@pasternack.com)