



## SMA Female Connector Solder Attachment 2 Hole Flange Mount for PE-SR405AL, PE-SR405FL, PE-SR405FLJ, RG405, .481 inch Hole Spacing

### RF Connectors Technical Data Sheet

PE4197

#### Configuration

- SMA Female Connector
- MIL-STD-348
- 50 Ohms
- Straight Body Geometry
- PE-SR405AL, PE-SR405FL, PE-SR405FLJ, RG405 Interface Type
- Solder/Solder Attachment
- 2 Hole Flange

#### Features

- Max. Operating Frequency 18 GHz
- Excellent VSWR of 1.25:1
- Gold Plated Beryllium Copper Contact
- Contact plating according to MIL-G-45204

#### Applications

- General Purpose Test
- Rack and Panel Mount Applications
- Custom Cable Assemblies

#### Description

Pasternack's PE4197 SMA female 2 hole flange mount connector with solder/solder attachment for PE-SR405AL, PE-SR405FL, PE-SR405FLJ and RG405 (.481 inch hole spacing) is part of our full line of RF components available for same-day shipping. Our SMA female connector operates up to a maximum frequency of 18 GHz and offers excellent VSWR of 1.25:1. This SMA 2 hole flange connector allows designers to create external connections on their product enclosures, and can be used in a variety of other rack mount and panel mount applications.

Our SMA female 2 hole flange connector PE4197 datasheet specifications and drawing with dimensions are shown below in this PDF. Pasternack's broad catalog of RF, microwave and millimeter wave connectors allows designers to configure and customize their signal connections however they like. Whether the need is to provide an I/O for a board design, or simply create a custom cable assembly configuration, Pasternack has the right connector for the job. Pasternack can also expertly build your custom cable assemblies for you and ship same-day.

#### Electrical Specifications

Description	Minimum	Typical	Maximum	Units
Frequency Range	DC		18	GHz
VSWR			1.25:1	
Operating Voltage (AC)			335	Vrms
Dielectric Withstanding Voltage (AC)			1,000	Vrms
Insulation Resistance	5,000			MOhms

#### Mechanical Specifications

##### Size

Length	0.5 in [12.7 mm]
Width/Dia.	0.25 in [6.35 mm]
Height	0.63 in [16 mm]

Click the following link (or enter part number in "SEARCH" on website) to obtain additional part information including price, inventory and certifications: [SMA Female Connector Solder Attachment 2 Hole Flange Mount for PE-SR405AL, PE-SR-405FL, PE-SR405FLJ, RG405, .481 inch Hole Spacing PE4197](#)



SMA Female Connector Solder Attachment  
 2 Hole Flange Mount for PE-SR405AL, PE-SR405FL,  
 PE-SR405FLJ, RG405, .481 inch Hole Spacing

RF Connectors Technical Data Sheet

PE4197

Weight 0.006 lbs [2.72 g]

**Material Specifications**

Description	Material	Plating
Contact	Beryllium Copper	Gold MIL-G-45204
Insulation	PTFE	
Body	Stainless Steel	Gold MIL-G-45204

**Environmental Specifications**

**Temperature**

Operating Range -65 to +165 deg C

**Compliance Certifications** (see [product page](#) for current document)

**Plotted and Other Data**

Notes:

SMA Female Connector Solder Attachment 2 Hole Flange Mount for PE-SR405AL, PE-SR405FL, PE-SR405FLJ, RG405, .481 inch Hole Spacing from Pasternack Enterprises has same day shipment for domestic and International orders. Our RF, microwave and millimeter wave products maintain a 99% availability and are part of the broadest selection in the industry.

Click the following link (or enter part number in "SEARCH" on website) to obtain additional part information including price, inventory and certifications: [SMA Female Connector Solder Attachment 2 Hole Flange Mount for PE-SR405AL, PE-SR405FL, PE-SR405FLJ, RG405, .481 inch Hole Spacing PE4197](#)

URL: <https://www.pasternack.com/sma-female-standard-pe-sr405al-pe-sr405fl-rg405-connector-pe4197-p.aspx>

The information contained in this document is accurate to the best of our knowledge and representative of the part described herein. It may be necessary to make modifications to the part and/or the documentation of the part, in order to implement improvements. Pasternack reserves the right to make such changes as required. Unless otherwise stated, all specifications are nominal. Pasternack does not make any representation or warranty regarding the suitability of the part described herein for any particular purpose, and Pasternack does not assume any liability arising out of the use of any part or documentation.

# PE4197 CAD Drawing

SMA Female Connector Solder Attachment 2 Hole Flange Mount for PE-SR405AL, PE-SR405FL, PE-SR405FLJ, RG405, .481 inch Hole Spacing

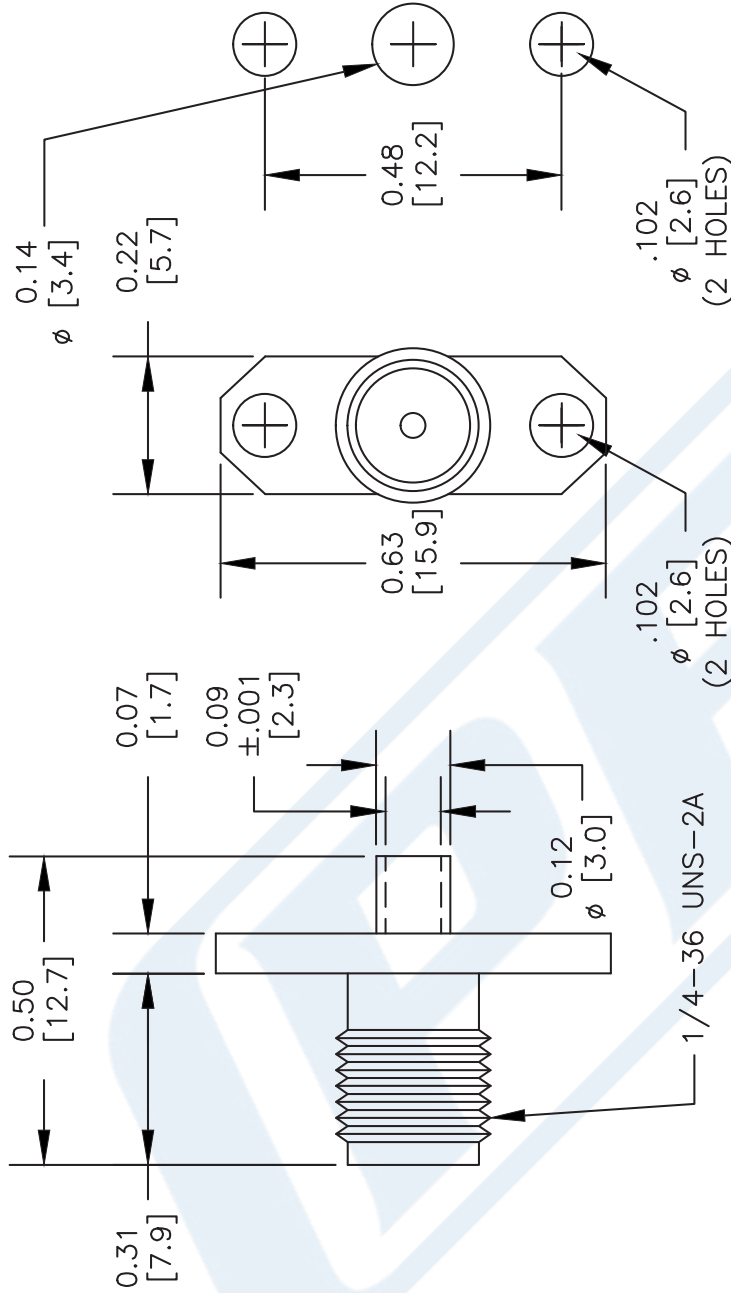

MOUNTING HOLES

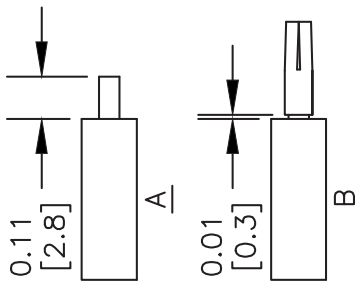

## STRIPPING DIMENSIONS

## ASSEMBLY PROCEDURES

1. STRIP CABLE AS SHOWN IN (A). DO NOT NICK CENTER CONDUCTOR.
2. SHIM CONTACT AS SHOWN IN (B) & SOLDER CONTACT TO CENTER CONDUCTOR.
3. INSERT CABLE INTO BODY UNTIL OUTER CONDUCTOR IS FLUSH WITH BODY SHOULDER. SOLDER OUTER CONDUCTOR TO BODY.

DWG TITLE

**PE4197**

NOTES:

1. UNLESS OTHERWISE SPECIFIED ALL DIMENSIONS ARE NOMINAL.
2. ALL SPECIFICATIONS ARE SUBJECT TO CHANGE WITHOUT NOTICE AT ANY TIME.
3. DIMENSIONS ARE IN INCHES [mm].
4. FITS MIL-C-17 AND EQUIVALENT CABLES.

REV. B

FSCM NO. 53919

CAD FILE 110711

SCALE N/A

SIZE A

2233



**PASTERNAK®**  
 Pasternack Enterprises, Inc.  
 P.O. Box 16759 | Irvine | CA | 92623  
 Phone: (949) 261-1920 | Fax: (949) 261-7451  
 Website: www.pasternack.com | E-Mail: sales@pasternack.com

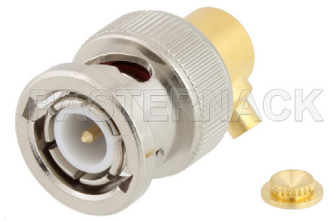

## BNC Male Right Angle Connector Solder Attachment for PE-SR405AL, PE-SR405FL, RG405

### RF Connectors Technical Data Sheet

**PE45239**

#### Configuration

- BNC Male Connector
- MIL-C-39012
- 50 Ohms
- Right Angle Body Geometry
- PE-SR405AL, PE-SR405FL, RG405 Interface Type
- Solder/Solder Attachment

#### Features

- Gold Plated Contact

#### Applications

- General Purpose Test
- Custom Cable Assemblies

#### Description

Pasternack's PE45239 BNC male right angle connector with solder/solder attachment for PE-SR405AL, PE-SR405FL and RG405 is part of our full line of RF components available for same-day shipping. Its right angle body geometry allows for easier connections in tight spaces.

Our BNC male right angle connector PE45239 datasheet specifications and drawing with dimensions are shown below in this PDF. Pasternack's broad catalog of RF, microwave and millimeter wave connectors allows designers to configure and customize their signal connections however they like. Whether the need is to provide an I/O for a board design, or simply create a custom cable assembly configuration, Pasternack has the right connector for the job. Pasternack can also expertly build your custom cable assemblies for you and ship same-day.

#### Mechanical Specifications

##### Size

Length	0.89 in [22.61 mm]
Width/Dia.	0.57 in [14.48 mm]
Weight	0.026 lbs [11.79 g]

##### Material Specifications

Description	Material	Plating
Contact		Gold
Insulation	Teflon	
Body	Brass	Gold MIL-G-45204
Coupling Nut	Brass	Nickel

Click the following link (or enter part number in "SEARCH" on website) to obtain additional part information including price, inventory and certifications: [BNC Male Right Angle Connector Solder Attachment for PE-SR405AL, PE-SR405FL, RG405 PE45239](#)

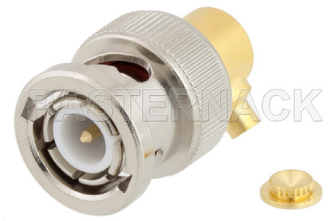

## BNC Male Right Angle Connector Solder Attachment for PE-SR405AL, PE-SR405FL, RG405

### RF Connectors Technical Data Sheet

**PE45239**

#### Environmental Specifications

##### Temperature

Operating Range

-65 to +165 deg C

**Compliance Certifications** (see [product page](#) for current document)

#### Plotted and Other Data

Notes:

BNC Male Right Angle Connector Solder Attachment for PE-SR405AL, PE-SR405FL, RG405 from Pasternack Enterprises has same day shipment for domestic and International orders. Our RF, microwave and millimeter wave products maintain a 99.4% availability and are part of the broadest selection in the industry.

Click the following link (or enter part number in "SEARCH" on website) to obtain additional part information including price, inventory and certifications: [BNC Male Right Angle Connector Solder Attachment for PE-SR405AL, PE-SR405FL, RG405 PE45239](#)

URL: <https://www.pasternack.com/bnc-male-pe-sr405al-pe-sr405fl-rg405-connector-pe45239-p.aspx>

The information contained in this document is accurate to the best of our knowledge and representative of the part described herein. It may be necessary to make modifications to the part and/or the documentation of the part, in order to implement improvements. Pasternack reserves the right to make such changes as required. Unless otherwise stated, all specifications are nominal. Pasternack does not make any representation or warranty regarding the suitability of the part described herein for any particular purpose, and Pasternack does not assume any liability arising out of the use of any part or documentation.

# PE45239 CAD Drawing

BNC Male Right Angle Connector Solder Attachment  
for PE-SR405AL, PE-SR405FL, RG405

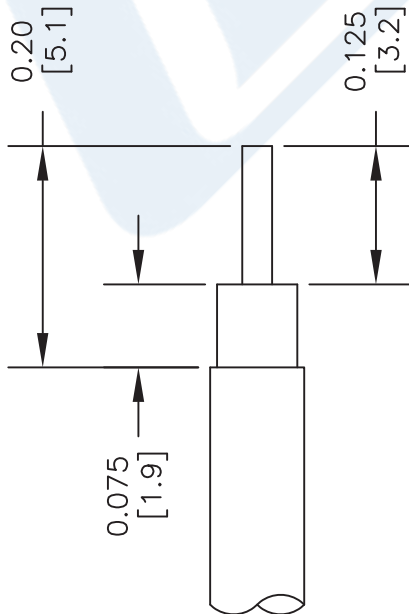
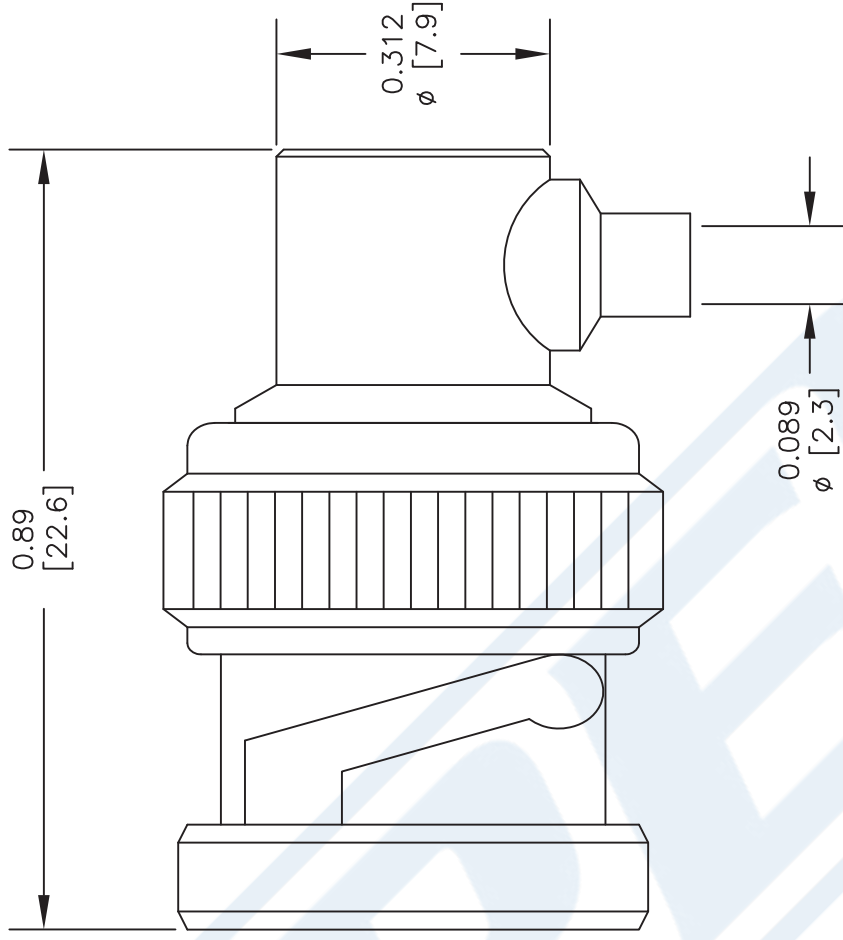

### STRIPPING DIMENSIONS ASSEMBLY PROCEDURES

1. STRIP CABLE AS SHOWN & TIN CENTER CONDUCTOR.
2. INSERT CABLE INTO BODY UNTIL OUTER CONDUCTOR BOTTOMS ON WITH CONNECTOR SHOULDER, THE CENTER CONDUCTOR WILL PROTRUDE INTO CONTACT SLOT.
3. SOLDER CONTACT INTO SLOT, SOLDER OUTER CONDUCTOR TO BODY. PRESS DOWN CAP.

NOTES:  
1. UNLESS OTHERWISE SPECIFIED ALL DIMENSIONS ARE NOMINAL.  
2. ALL SPECIFICATIONS ARE SUBJECT TO CHANGE WITHOUT NOTICE AT ANY TIME.  
3. DIMENSIONS ARE IN INCHES [mm].  
4. FITS MIL-C-17 AND EQUIVALENT CABLES.

DWG TITLE	<b>PE45239</b>		
FSCM NO.	53919	CAD FILE	050916
SCALE	N/A	SIZE A	2233

**(PE) PASTERNAK®**  
THE ENGINEER'S RF SOURCE  
Pasternack Enterprises, Inc.  
P.O. Box 16759 | Irvine | CA | 92623  
Phone: (949) 261-1920 | Fax: (949) 261-7451  
Website: www.pasternack.com | E-Mail: sales@pasternack.com

# RG405 Coax Cable with Tinned Copper Outer Conductor

## RF Cables Technical Data Sheet

PE-SR405TN

### Configuration

- Semi-Rigid Cable
- MIL-C-17
- 1 Shield(s)

### Electrical Specifications

Description	Minimum	Typical	Maximum	Units
Frequency Range	DC		40	GHz
Impedance		50		Ohms

### Performance by Frequency Band

Description	F1	F2	F3	F4	F5	Units
Frequency	1	10	20			GHz
Attenuation, Typ	22	80	120			dB/100ft
	72.18	262.47	393.7			dB/100m
Input Power (CW), Max	130	35	20			Watts

### Mechanical Specifications

Min. Bend Radius (Installation) 0.05 in [1.27 mm]

### Construction Specifications

Description	Material and Plating	Diameter
Inner Conductor	Copper Clad Steel, Silver, 1 Strands	0.02 in [0.51 mm]
Conductor Type	Solid	
Dielectric	PTFE	0.066 in [1.68 mm]
First Shield	Tinned Copper	

Click the following link (or enter part number in "SEARCH" on website) to obtain additional part information including price, inventory and certifications: [RG405 Tinned Coax Cable with Tinned Copper Outer Conductor PE-SR405TN](#)

## RG405 Coax Cable with Tinned Copper Outer Conductor

### RF Cables Technical Data Sheet

PE-SR405TN

#### Environmental Specifications

##### Temperature

Operating Range

-55 to +125 deg C

**Compliance Certifications** (see [product page](#) for current document)

#### Plotted and Other Data

Notes:

RG405 Coax Cable with Tinned Copper Outer Conductor from Pasternack Enterprises has same day shipment for domestic and International orders. Our RF, microwave and millimeter wave products maintain a 99.4% availability and are part of the broadest selection in the industry.

Click the following link (or enter part number in "SEARCH" on website) to obtain additional part information including price, inventory and certifications: [RG405 Tinned Coax Cable with Tinned Copper Outer Conductor PE-SR405TN](#)

URL: <https://www.pasternack.com/50-ohm-semi-rigid-rg405-tinned-tinned-copper-pe-sr405tn-p.aspx>

The information contained in this document is accurate to the best of our knowledge and representative of the part described herein. It may be necessary to make modifications to the part and/or the documentation of the part, in order to implement improvements. Pasternack reserves the right to make such changes as required. Unless otherwise stated, all specifications are nominal. Pasternack does not make any representation or warranty regarding the suitability of the part described herein for any particular purpose, and Pasternack does not assume any liability arising out of the use of any part or documentation.

# PE-SR405TN CAD Drawing

RG405 Coax Cable with Tinned Copper Outer Conductor

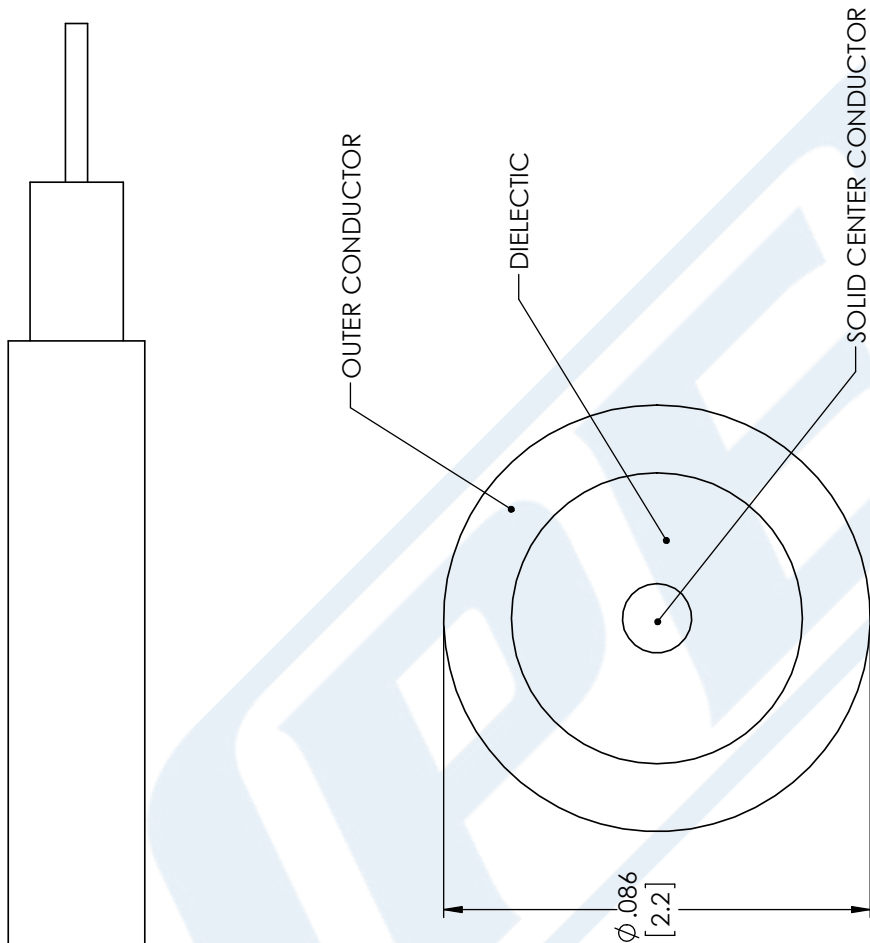

**STANDARD TOLERANCES**

.X ±0.2  
 .XX ±0.01  
 .XXX ±0.005

\*STANDARD TOLERANCES APPLY ONLY TO DIMENSIONS IN INCHES



Pasternack Enterprises, Inc.  
 P.O. Box 16759 | Irvine | CA | 92623  
**Phone:** (949) 261-1920 | **Fax:** (949) 261-7451  
**Website:** www.pasternack.com | **E-Mail:** sales@pasternack.com

DWG TITLE

PE-SR405TN

NOTES:  
 1. UNLESS OTHERWISE SPECIFIED ALL DIMENSIONS ARE NOMINAL.  
 2. ALL SPECIFICATIONS ARE SUBJECT TO CHANGE WITHOUT NOTICE AT ANY TIME.  
 3. DIMENSIONS ARE IN INCHES [mm].

**CAGE CODE 53919**

CAD FILE 11/28/17

SCALE N/A

SIZE A

CN2245