



## QMA Female Bulkhead Mount Connector Solder Attachment for PE-SR405AL, PE-SR405FL, RG405, .268 inch D Hole

### RF Connectors Technical Data Sheet

PE45218

#### Configuration

- QMA Female Connector
- 50 Ohms
- Straight Body Geometry
- PE-SR405AL, PE-SR405FL, RG405 Interface Type
- Solder/Solder Attachment
- Bulkhead

#### Features

- Max. Operating Frequency 6 GHz
- Excellent VSWR of 1.15:1
- Gold Plated Beryllium Copper Contact

#### Applications

- General Purpose Test
- Rack and Panel Mount Applications
- Custom Cable Assemblies

#### Description

Pasternack's PE45218 QMA female bulkhead connector with solder/solder attachment for PE-SR405AL, PE-SR405FL and RG405 (.268 inch D hole) is part of our full line of RF components available for same-day shipping. Our QMA female connector operates up to a maximum frequency of 6 GHz and offers excellent VSWR of 1.15:1. This QMA bulkhead connector allows designers to create external connections on their product enclosures, and can be used in a variety of other rack mount and panel mount applications.

Our QMA female bulkhead connector PE45218 datasheet specifications and drawing with dimensions are shown below in this PDF. Pasternack's broad catalog of RF, microwave and millimeter wave connectors allows designers to configure and customize their signal connections however they like. Whether the need is to provide an I/O for a board design, or simply create a custom cable assembly configuration, Pasternack has the right connector for the job. Pasternack can also expertly build your custom cable assemblies for you and ship same-day.

#### Electrical Specifications

Description	Minimum	Typical	Maximum	Units
Frequency Range	DC		6	GHz
VSWR			1.15:1	
Insertion Loss			0.12	dB
Dielectric Withstanding Voltage (AC)			1,000	Vrms
Insulation Resistance	5,000			MOhms

#### Mechanical Specifications

##### Size

Length	0.787 in [19.99 mm]
Width/Dia.	0.433 in [11.00 mm]
Weight	0.01 lbs [4.54 g]

Click the following link (or enter part number in "SEARCH" on website) to obtain additional part information including price, inventory and certifications: [QMA Female Bulkhead Mount Connector Solder Attachment for PE-SR405AL, PE-SR405FL, RG405, .268 inch D Hole PE45218](#)



QMA Female Bulkhead Mount Connector Solder Attachment  
for PE-SR405AL, PE-SR405FL, RG405, .268 inch D Hole

RF Connectors Technical Data Sheet

PE45218

**Material Specifications**

Description	Material	Plating
Contact	Beryllium Copper	Gold
Insulation	PTFE	
Outer Conductor	Brass	Gold
Body	Brass	Gold
Gasket	Silicone Rubber	

**Environmental Specifications**

**Temperature**

Operating Range -40 to +105 deg C

**Compliance Certifications** (see [product page](#) for current document)

**Plotted and Other Data**

Notes:

QMA Female Bulkhead Mount Connector Solder Attachment for PE-SR405AL, PE-SR405FL, RG405, .268 inch D Hole from Pasternack Enterprises has same day shipment for domestic and International orders. Our RF, microwave and millimeter wave products maintain a 99.4% availability and are part of the broadest selection in the industry.

Click the following link (or enter part number in "SEARCH" on website) to obtain additional part information including price, inventory and certifications: [QMA Female Bulkhead Mount Connector Solder Attachment for PE-SR405AL, PE-SR405FL, RG405, .268 inch D Hole PE45218](#)

URL: <https://www.pasternack.com/qma-female-pe-sr405al-pe-sr405fl-rg405-connector-pe45218-p.aspx>

The information contained in this document is accurate to the best of our knowledge and representative of the part described herein. It may be necessary to make modifications to the part and/or the documentation of the part, in order to implement improvements. Pasternack reserves the right to make such changes as required. Unless otherwise stated, all specifications are nominal. Pasternack does not make any representation or warranty regarding the suitability of the part described herein for any particular purpose, and Pasternack does not assume any liability arising out of the use of any part or documentation.

# PE45218 CAD Drawing

QMA Female Bulkhead Mount Connector Solder Attachment for PE-SR405AL, PE-SR405FL, RG405, .268 inch D Hole

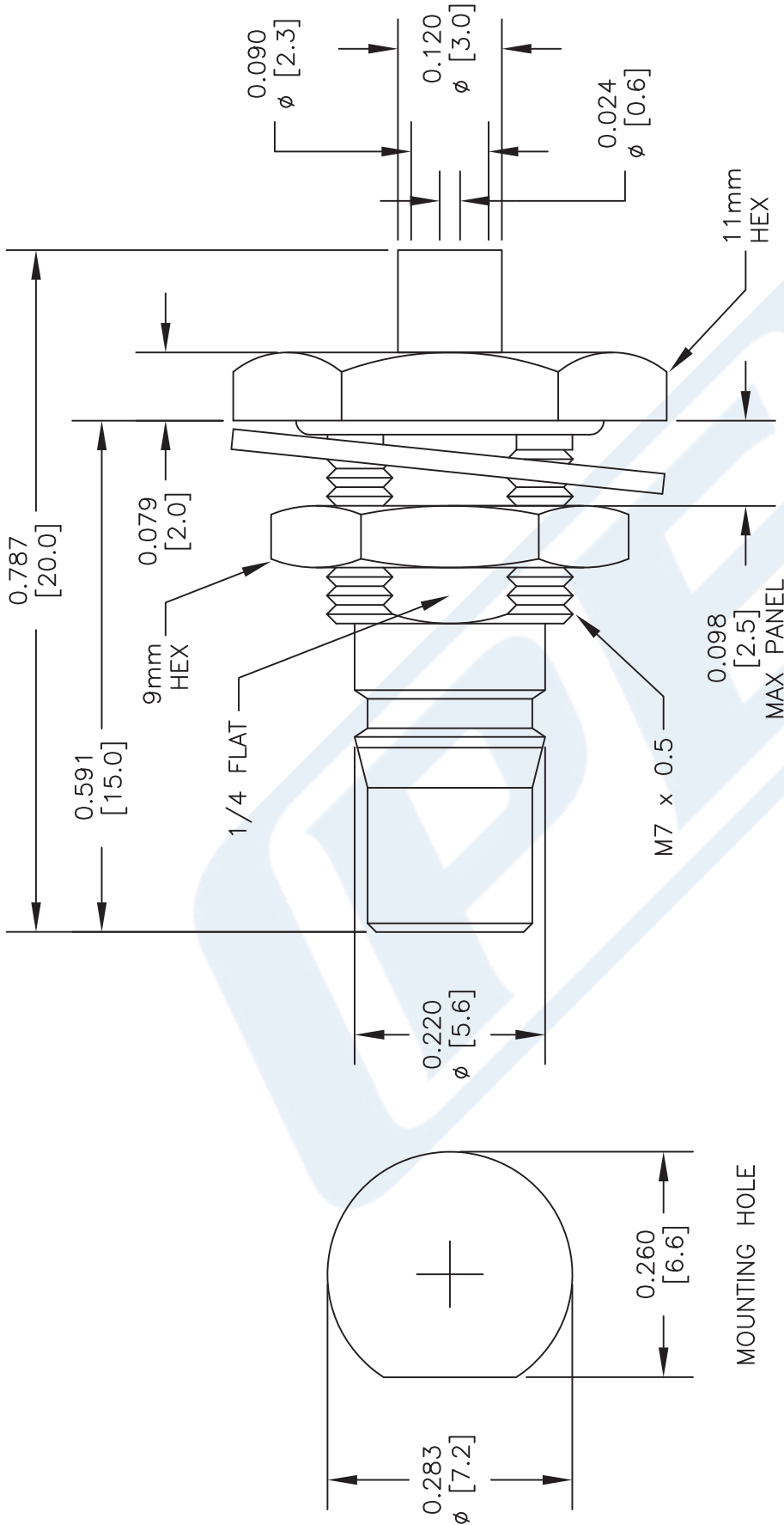

## ASSEMBLY PROCEDURES

1. STRIP CABLE AS SHOWN. DO NOT NICK CENTER CONDUCTOR.
2. PLACE CONTACT OVER CENTER CONDUCTOR AS SHOWN. SOLDER CONTACT TO CENTER CONDUCTOR AS SHOWN.
3. INSERT CABLE AND CONTACT INTO CONNECTOR BODY UNTIL FULLY ENGAGED. SOLDER BODY TO CABLE.

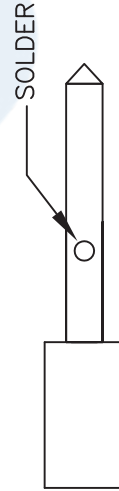
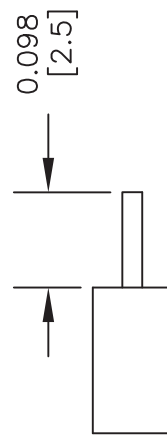

DWG TITLE

**PE45218**

- NOTES:
1. UNLESS OTHERWISE SPECIFIED ALL DIMENSIONS ARE NOMINAL.
  2. ALL SPECIFICATIONS ARE SUBJECT TO CHANGE WITHOUT NOTICE AT ANY TIME.
  3. DIMENSIONS ARE IN INCHES [mm].
  4. FITS MIL-C-17 AND EQUIVALENT CABLES.

**PE PASTERNAK**  
THE ENGINEER'S RF SOURCE  
Pasternack Enterprises, Inc.  
P.O. Box 16759 | Irvine | CA | 92623  
Phone: (949) 261-1920 | Fax: (949) 261-7451  
Website: www.pasternack.com | E-Mail: sales@pasternack.com

FSCM NO. 53919

CAD FILE 110216

SCALE N/A

SIZE A

2233



## SMA Male Connector Solder Attachment for PE-SR405AL, PE-SR405FL, RG405

### RF Connectors Technical Data Sheet

PE4005

#### Configuration

- SMA Male Connector
- MIL-STD-348A
- 50 Ohms
- Straight Body Geometry
- PE-SR405AL, PE-SR405FL, RG405 Interface Type
- Solder/Solder Attachment
- 5/16 inch Hex

#### Features

- Max. Operating Frequency 18 GHz
- Good VSWR of 1.5:1
- Gold Plated Brass Contact
- 50 µin minimum contact plating

#### Applications

- General Purpose Test
- Custom Cable Assemblies

#### Description

Pasternack's PE4005 SMA male connector with solder/solder attachment for PE-SR405AL, PE-SR405FL and RG405 is part of our full line of RF components available for same-day shipping. Our SMA male connector operates up to a maximum frequency of 18 GHz and offers good VSWR of 1.5:1.

Our SMA male connector PE4005 datasheet specifications and drawing with dimensions are shown below in this PDF. Pasternack's broad catalog of RF, microwave and millimeter wave connectors allows designers to configure and customize their signal connections however they like. Whether the need is to provide an I/O for a board design, or simply create a custom cable assembly configuration, Pasternack has the right connector for the job. Pasternack can also expertly build your custom cable assemblies for you and ship same-day.

#### Electrical Specifications

Description	Minimum	Typical	Maximum	Units
Frequency Range	DC		18	GHz
VSWR			1.5:1	
Operating Voltage (AC)			335	Vrms

#### Mechanical Specifications

##### Size

Length	0.406 in [10.31 mm]
Width/Dia.	0.315 in [8.00 mm]
Weight	0.011 lbs [4.99 g]
Mating Cycles	500 Cycles
Mating Torque	3 to 5 in-lbs [0.34 to 0.57 Nm]

Click the following link (or enter part number in "SEARCH" on website) to obtain additional part information including price, inventory and certifications: [SMA Male Connector Solder Attachment for PE-SR405AL, PE-SR405FL, RG405 PE4005](#)



SMA Male Connector Solder Attachment for PE-SR405AL, PE-SR405FL, RG405

RF Connectors Technical Data Sheet

PE4005

**Material Specifications**

Description	Material	Plating
Contact	Brass	Gold 50 µin minimum
Insulation	PTFE	
Body	Stainless Steel	Gold 10 µin minimum
Coupling Nut	Brass	Nickel 100 µin minimum

**Environmental Specifications**

**Temperature**

Operating Range

-65 to +165 deg C

**Compliance Certifications** (see [product page](#) for current document)

**Plotted and Other Data**

Notes:

SMA Male Connector Solder Attachment for PE-SR405AL, PE-SR405FL, RG405 from Pasternack Enterprises has same day shipment for domestic and International orders. Our RF, microwave and millimeter wave products maintain a 99% availability and are part of the broadest selection in the industry.

Click the following link (or enter part number in "SEARCH" on website) to obtain additional part information including price, inventory and certifications: [SMA Male Connector Solder Attachment for PE-SR405AL, PE-SR405FL, RG405 PE4005](#)

URL: <https://www.pasternack.com/sma-male-pe-sr405al-pe-sr405fl-pe-sr405flj-pe-sr405tn-rg405-connector-pe4005-p.aspx>

The information contained in this document is accurate to the best of our knowledge and representative of the part described herein. It may be necessary to make modifications to the part and/or the documentation of the part, in order to implement improvements. Pasternack reserves the right to make such changes as required. Unless otherwise stated, all specifications are nominal. Pasternack does not make any representation or warranty regarding the suitability of the part described herein for any particular purpose, and Pasternack does not assume any liability arising out of the use of any part or documentation.

# PE4005 CAD Drawing

SMA Male Connector Solder Attachment for PE-SR405AL, PE-SR405FL, RG405

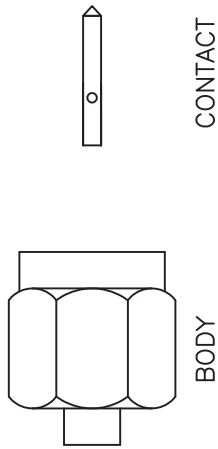

### ASSEMBLY PROCEDURES

1. STRIP CABLE AS SHOWN. DO NOT NICK CENTER CONDUCTOR.

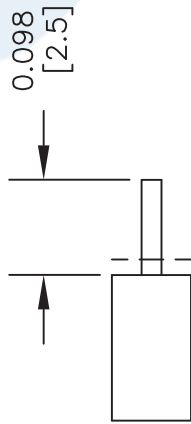

2. PLACE CONTACT OVER CENTER CONDUCTOR AS SHOWN. SOLDER CONTACT TO CENTER CONDUCTOR AS SHOWN.



3. INSERT CABLE AND CONTACT INTO CONNECTOR BODY UNTIL FULLY ENGAGED. SOLDER BODY TO CABLE.

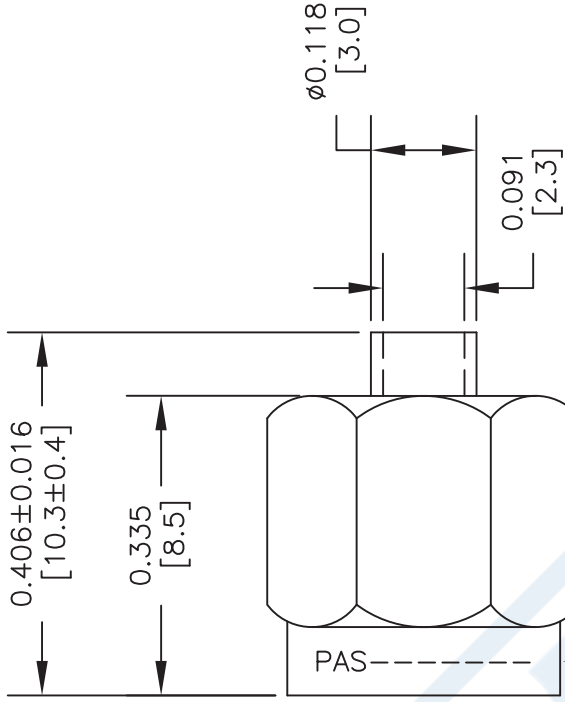
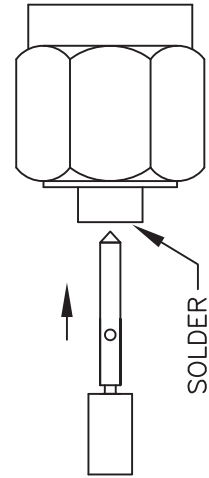

STANDARD TOLERANCES	
.X	±0.2
.XX	±0.1
.XXX	±0.05

\*STANDARD TOLERANCES APPLY ONLY TO DIMENSIONS IN INCHES

### NOTES:

1. UNLESS OTHERWISE SPECIFIED ALL DIMENSIONS ARE NOMINAL.
2. ALL SPECIFICATIONS ARE SUBJECT TO CHANGE WITHOUT NOTICE AT ANY TIME.
3. DIMENSIONS ARE IN INCHES [mm].

DWG TITLE

**PE4005**

FSCM NO. 53919

CAD FILE 071316

SCALE N/A

SIZE A

2233

**PE PASTERNAK**  
THE ENGINEER'S RF SOURCE

Pasternack Enterprises, Inc.  
P.O. Box 16759 | Irvine | CA | 92623  
Phone: (949) 261-1920 | Fax: (949) 261-7451  
Website: www.pasternack.com | E-Mail: sales@pasternack.com



## Formable 086 Semirigid Coax Cable with Tinned Braid Outer Conductor and Black FEP Jacket

### RF Cables Technical Data Sheet

PE-SR405FLJ

#### Configuration

- Formable Cable
- 1 Shield(s)

#### Features

- Dimensionally the same as standard solid outer conductor semi-rigid coax
- Standard semi-rigid connectors can be used
- Cable is hand formable and does not require special tools to bend
- Connectors are easily soldered to Tin soaked outer conductor
- Cable can be formed more than once without damage to outer conductor
- High RF Shielding >100 dB

#### Description

Formable semi-rigid coax is a hand formable version of standard semi-rigid that does not require complicated and costly pre-formed cable assemblies. Because the dimensions and electrical characteristics are so closely matched to semi-rigid coax, standard semi-rigid connectors can be used. The tin soaked copper braid outer shield provides excellent RF shielding. FEP Jacket reduces the chance of shorting exposed contacts or circuit conductors.

#### Electrical Specifications

Description	Minimum	Typical	Maximum	Units
Frequency Range	DC		61	GHz
Impedance		50		Ohms
Velocity of Propagation		69.5		%
Time Delay		1.43 [4.69]		ns/ft [ns/m]
Shielding Effectiveness	100			dB
Operating Voltage (AC)			1,500	Vrms
Inner Conductor DC Resistance			65.7	Ohms/1000ft
Outer Conductor DC Resistance			10.2	Ohms/1000ft
Nominal Capacitance		29 [95.14]		pF/ft [pF/m]

#### Performance by Frequency Band

Description	F1	F2	F3	F4	F5	Units
Frequency	0.5	1	5	10	20	GHz
Attenuation, Typ	15	22.5	54.9	81.2	120	dB/100ft
	49.21	73.82	180.12	266.4	393.7	dB/100m
Input Power (CW), Max	173.5	121.5	52.2	35.8	24.3	Watts

Click the following link (or enter part number in "SEARCH" on website) to obtain additional part information including price, inventory and certifications: [Formable PE-SR405FLJ Coax Cable with Outer Conductor and Black FEP Jacket PE-SR-405FLJ](#)



## Formable 086 Semirigid Coax Cable with Tinned Braid Outer Conductor and Black FEP Jacket

### RF Cables Technical Data Sheet

PE-SR405FLJ

#### Mechanical Specifications

Diameter	0.105 in [2.67 mm]
Weight	0.015 lbs/ft [0.02 Kg/m]
Min. Bend Radius (Installation)	0.5 in [12.7 mm]
Min. Bend Radius (Repeated)	0.787 in [19.99 mm]

#### Construction Specifications

Description	Material and Plating	Diameter
Inner Conductor	Copper Clad Steel, Silver, 1 Strands	0.02 in [0.51 mm]
Conductor Type	Solid	
Dielectric	PTFE	0.062 in [1.57 mm]
Outer Conductor	Tinned Copper Composite Braid	0.085 in [2.16 mm]
Jacket	FEP, Black	0.105 in [2.67 mm]

#### Environmental Specifications

##### Temperature

Operating Range	-55 to +125 deg C
-----------------	-------------------

#### Compliance Certifications (see [product page](#) for current document)

#### Plotted and Other Data

Notes:

Formable 086 Semirigid Coax Cable with Tinned Braid Outer Conductor and Black FEP Jacket from Pasternack Enterprises has same day shipment for domestic and International orders. Our RF, microwave and millimeter wave products maintain a 99.4% availability and are part of the broadest selection in the industry.

Click the following link (or enter part number in "SEARCH" on website) to obtain additional part information including price, inventory and certifications: [Formable PE-SR405FLJ Coax Cable with Outer Conductor and Black FEP Jacket PE-SR405FLJ](#)

URL: <https://www.pasternack.com/50-ohm-formable-086-semirigid-tinned-braid-outer-conductor-fep-jacket-black-pe-sr405flj-p.aspx>

The information contained in this document is accurate to the best of our knowledge and representative of the part described herein. It may be necessary to make modifications to the part and/or the documentation of the part, in order to implement improvements. Pasternack reserves the right to make such changes as required. Unless otherwise stated, all specifications are nominal. Pasternack does not make any representation or warranty regarding the suitability of the part described herein for any particular purpose, and Pasternack does not assume any liability arising out of the use of any part or documentation.

# PE-SR405FLJ CAD Drawing

Formable 086 Semirigid Coax Cable with Tinned Braid  
Outer Conductor and Black FEP Jacket



NOTES:  
1. UNLESS OTHERWISE SPECIFIED ALL DIMENSIONS ARE NOMINAL.  
2. ALL SPECIFICATIONS ARE SUBJECT TO CHANGE WITHOUT NOTICE AT ANY TIME.  
3. DIMENSIONS ARE IN INCHES [mm].

DWG TITLE  
**PE-SR405FLJ**

CAGE CODE 53919

CAD FILE 062817 SCALE N/A SIZE A 2233

**(PE) PASTERNAK®**  
THE ENGINEER'S RF SOURCE  
Pasternack Enterprises, Inc.  
P.O. Box 16759 | Irvine | CA | 92623  
Phone: (949) 261-1920 | Fax: (949) 261-7451  
Website: www.pasternack.com | E-Mail: sales@pasternack.com