



SMA Male Connector Solder Attachment for PE-SR402AL, PE-SR402FL, PE-SR402FLJ, PE-SR402TN, RG402

RF Connectors Technical Data Sheet

PE44691

Configuration

- SMA Male Connector
- 50 Ohms
- Straight Body Geometry
- PE-SR402AL, PE-SR402FL, PE-SR402FLJ, PE-SR402TN, RG402 Interface Type
- Solder Attachment
- 5/16 inch Hex

Features

- Max. Operating Frequency 18 GHz

Applications

- General Purpose Test
- Custom Cable Assemblies

Description

Pasternack's PE44691 SMA male connector with solder attachment for PE-SR402AL, PE-SR402FL, PE-SR402FLJ, PE-SR402TN and RG402 is part of our full line of RF components available for same-day shipping. Our SMA male connector operates up to a maximum frequency of 18 GHz.

Our SMA male connector PE44691 datasheet specifications and drawing with dimensions are shown below in this PDF. Pasternack's broad catalog of RF, microwave and millimeter wave connectors allows designers to configure and customize their signal connections however they like. Whether the need is to provide an I/O for a board design, or simply create a custom cable assembly configuration, Pasternack has the right connector for the job. Pasternack can also expertly build your custom cable assemblies for you and ship same-day.

Electrical Specifications

Description	Minimum	Typical	Maximum	Units
Frequency Range	DC		18	GHz

Mechanical Specifications

Size	
Length	0.441 in [11.2 mm]
Width/Dia.	0.315 in [8.00 mm]
Weight	0.005 lbs [2.27 g]
Mating Torque	8 to 10 in-lbs [0.90 to 1.13 Nm]

Click the following link (or enter part number in "SEARCH" on website) to obtain additional part information including price, inventory and certifications: [SMA Male Connector Solder Attachment for PE-SR402AL, PE-SR402FL, PE-SR402FLJ, PE-SR402TN, RG402 PE44691](#)



SMA Male Connector Solder Attachment for PE-SR402AL, PE-SR402FL, PE-SR402FLJ, PE-SR402TN, RG402

RF Connectors Technical Data Sheet

PE44691

Material Specifications

Description	Material	Plating
Body	Brass	Gold over Nickel
Coupling Nut	Passivated Stainless Steel	

Compliance Certifications (see [product page](#) for current document)

Plotted and Other Data

Notes:

SMA Male Connector Solder Attachment for PE-SR402AL, PE-SR402FL, PE-SR402FLJ, PE-SR402TN, RG402 from Pasternack Enterprises has same day shipment for domestic and International orders. Our RF, microwave and millimeter wave products maintain a 99.4% availability and are part of the broadest selection in the industry.

Click the following link (or enter part number in "SEARCH" on website) to obtain additional part information including price, inventory and certifications: [SMA Male Connector Solder Attachment for PE-SR402AL, PE-SR402FL, PE-SR402FLJ, PE-SR402TN, RG402 PE44691](#)

URL: <https://www.pasternack.com/sma-male-standard-pe-sr402al-pe-sr402fl-pe-sr402flj-connector-pe44691-p.aspx>

The information contained in this document is accurate to the best of our knowledge and representative of the part described herein. It may be necessary to make modifications to the part and/or the documentation of the part, in order to implement improvements. Pasternack reserves the right to make such changes as required. Unless otherwise stated, all specifications are nominal. Pasternack does not make any representation or warranty regarding the suitability of the part described herein for any particular purpose, and Pasternack does not assume any liability arising out of the use of any part or documentation.

PE44691 CAD Drawing

SMA Male Connector Solder Attachment for PE-SR402AL, PE-SR402FL, PE-SR402FLJ, PE-SR402TN, RG402

ASSEMBLY PROCEDURES

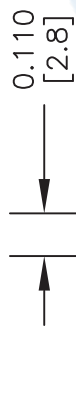

1. STRIP CABLE AS SHOWN.

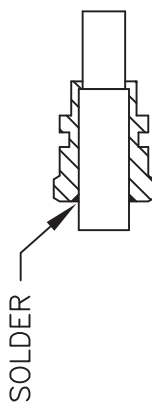

2. SOLDER CONNECTOR BODY.

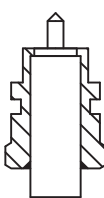

3. TRIM DIELECTRIC, DO NOT NICK CENTER CONDUCTOR AND POINT THE CENTER CONTACT OF CABLE.

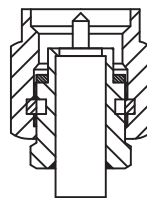

4. INSTALL THE COUPLING NUT.

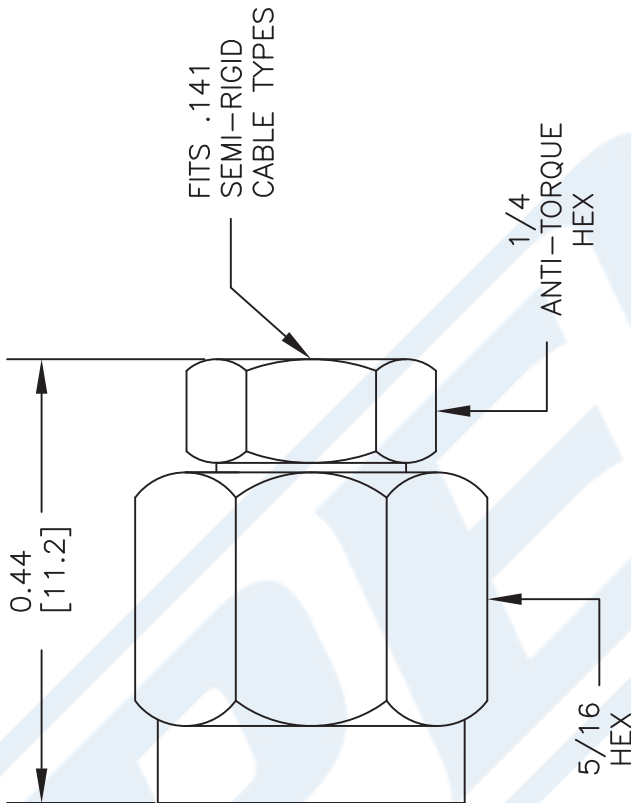

DWG TITLE

PE44691

NOTES:
1. UNLESS OTHERWISE SPECIFIED ALL DIMENSIONS ARE NOMINAL.
2. ALL SPECIFICATIONS ARE SUBJECT TO CHANGE WITHOUT NOTICE AT ANY TIME.
3. DIMENSIONS ARE IN INCHES [mm].
4. FITS MIL-C-17 AND EQUIVALENT CABLES.

REV. A

FSCM NO. 53919

CAD FILE 050412

SCALE N/A

SIZE A

2233

PE PASTERNAK
THE ENGINEER'S RF SOURCE

Pasternack Enterprises, Inc.
P.O. Box 16759 | Irvine | CA | 92623
Phone: (949) 261-1920 | Fax: (949) 261-7451
Website: www.pasternack.com | E-Mail: sales@pasternack.com



SMA Female Bulkhead Mount Connector Solder Attachment for PE-SR402AL, PE-SR402FL, PE-SR402FLJ, PE-SR402TN, RG402, .235 inch D Hole

RF Connectors Technical Data Sheet

PE4120

Configuration

- SMA Female Connector
- MIL-STD-348A
- 50 Ohms
- Straight Body Geometry
- PE-SR402AL, PE-SR402FL, PE-SR402FLJ, PE-SR402TN, RG402 Interface Type
- Solder/Solder Attachment
- Bulkhead

Features

- Max. Operating Frequency 18 GHz
- Gold Plated Beryllium Copper Contact
- 50 µin minimum contact plating

Applications

- General Purpose Test
- Rack and Panel Mount Applications
- Custom Cable Assemblies

Description

Pasternack's PE4120 SMA female bulkhead connector with solder/solder attachment for PE-SR402AL, PE-SR402FL, PE-SR402FLJ, PE-SR402TN and RG402 (.235 inch D hole) is part of our full line of RF components available for same-day shipping. Our SMA female connector operates up to a maximum frequency of 18 GHz. This SMA bulkhead connector allows designers to create external connections on their product enclosures, and can be used in a variety of other rack mount and panel mount applications.

Our SMA female bulkhead connector PE4120 datasheet specifications and drawing with dimensions are shown below in this PDF. Pasternack's broad catalog of RF, microwave and millimeter wave connectors allows designers to configure and customize their signal connections however they like. Whether the need is to provide an I/O for a board design, or simply create a custom cable assembly configuration, Pasternack has the right connector for the job. Pasternack can also expertly build your custom cable assemblies for you and ship same-day.

Electrical Specifications

Description	Minimum	Typical	Maximum	Units
Frequency Range	DC		18	GHz
Operating Voltage (AC)			500	Vrms
Dielectric Withstanding Voltage (AC)			1,000	Vrms

Performance by Frequency

Description	F1	F2	F3	F4	F5	Units
Frequency Range	DC to 6					GHz
VSWR, Max	1.23:1					

Click the following link (or enter part number in "SEARCH" on website) to obtain additional part information including price, inventory and certifications: [SMA Female Bulkhead Mount Connector Solder Attachment for PE-SR402AL, PE-SR402FL, PE-SR402FLJ, PE-SR402TN, RG402, .235 inch D Hole PE4120](#)



SMA Female Bulkhead Mount Connector Solder Attachment for PE-SR402AL, PE-SR402FL, PE-SR402FLJ, PE-SR402TN, RG402, .235 inch D Hole

RF Connectors Technical Data Sheet

PE4120

Mechanical Specifications

Size

Length	0.748 in [19 mm]
Width/Dia.	0.433 in [11.00 mm]
Weight	0.006 lbs [2.72 g]

Material Specifications

Description	Material	Plating
Contact	Beryllium Copper	Gold 50 µin minimum
Insulation	PTFE	
Body	Stainless Steel	Gold 30 µin minimum

Environmental Specifications

Temperature

Operating Range	-65 to +165 deg C
-----------------	-------------------

Compliance Certifications (see [product page](#) for current document)

Plotted and Other Data

Notes:

SMA Female Bulkhead Mount Connector Solder Attachment for PE-SR402AL, PE-SR402FL, PE-SR402FLJ, PE-SR402TN, RG402, .235 inch D Hole from Pasternack Enterprises has same day shipment for domestic and International orders. Our RF, microwave and millimeter wave products maintain a 99% availability and are part of the broadest selection in the industry.

Click the following link (or enter part number in "SEARCH" on website) to obtain additional part information including price, inventory and certifications: [SMA Female Bulkhead Mount Connector Solder Attachment for PE-SR402AL, PE-SR402FL, PE-SR402FLJ, PE-SR402TN, RG402, .235 inch D Hole PE4120](#)

URL: <https://www.pasternack.com/sma-female-standard-pe-sr402al-pe-sr402fl-rg402-connector-pe4120-p.aspx>

The information contained in this document is accurate to the best of our knowledge and representative of the part described herein. It may be necessary to make modifications to the part and/or the documentation of the part, in order to implement improvements. Pasternack reserves the right to make such changes as required. Unless otherwise stated, all specifications are nominal. Pasternack does not make any representation or warranty regarding the suitability of the part described herein for any particular purpose, and Pasternack does not assume any liability arising out of the use of any part or documentation.

PE4120 CAD Drawing

SMA Female Bulkhead Mount Connector Solder Attachment for PE-SR402AL, PE-SR402FL, PE-SR402FLJ, PE-SR402TN, RG402, .235 inch D Hole

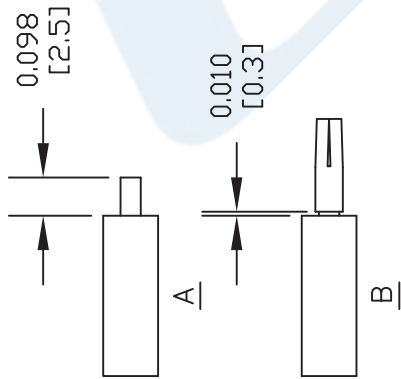
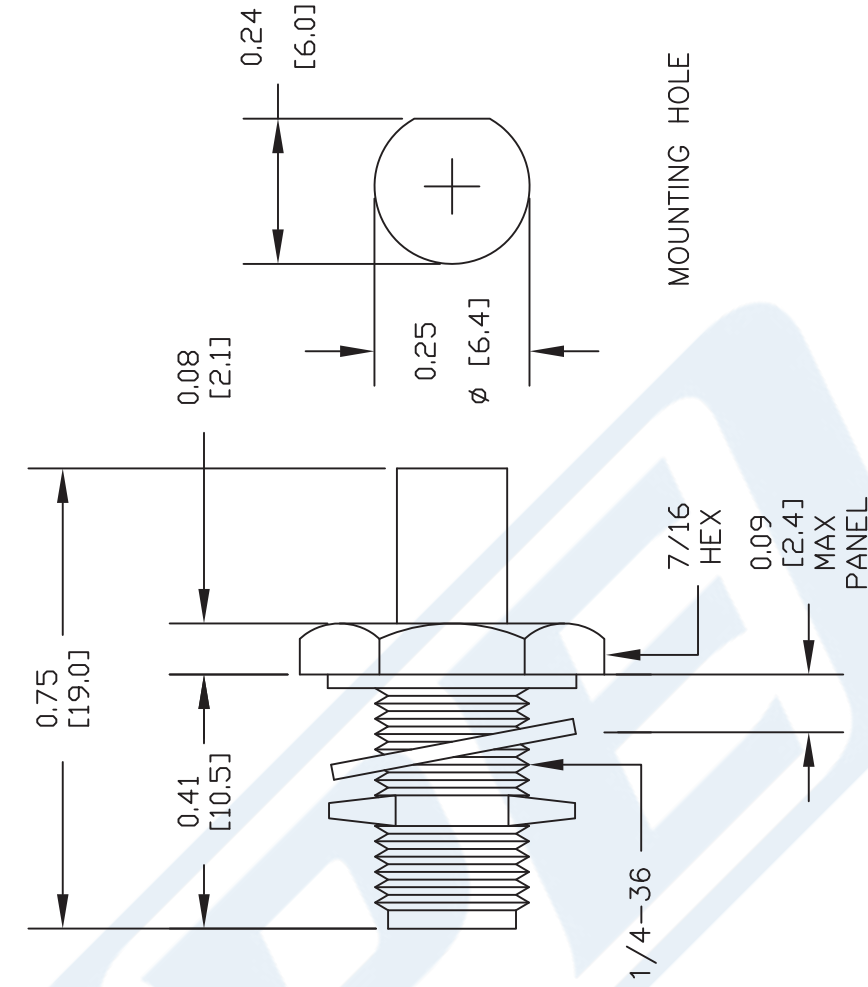

STRIPPING DIMENSIONS

ASSEMBLY PROCEDURES

1. STRIP CABLE AS SHOWN IN (A). DO NOT NICK CENTER CONDUCTOR.
2. SHIM CONTACT AS SHOWN IN (B) & SOLDER CONTACT TO CENTER CONDUCTOR.
3. INSERT CABLE INTO BODY UNTIL OUTER CONDUCTOR BOTTOMS OUT. SOLDER OUTER CONDUCTOR TO BODY.

DWG TITLE

PE4120

- NOTES:
1. UNLESS OTHERWISE SPECIFIED ALL DIMENSIONS ARE NOMINAL.
 2. ALL SPECIFICATIONS ARE SUBJECT TO CHANGE WITHOUT NOTICE AT ANY TIME.
 3. DIMENSIONS ARE IN INCHES [mm].
 4. FITS MIL-C-17 AND EQUIVALENT CABLES.

REV. A

FSCM NO. 53919

CAD FILE 073012

SCALE N/A

SIZE A

2231



PASTERNAK®
 Pasternack Enterprises, Inc.
 P.O. Box 16759 | Irvine | CA | 92623
Phone: (949) 261-1920 | **Fax:** (949) 261-7451
Website: www.pasternack.com | **E-Mail:** sales@pasternack.com



Formable 141 Semirigid Coax Cable with Tinned Braid Outer Conductor and Black FEP Jacket

RF Cables Technical Data Sheet

PE-SR402FLJ

Configuration

- Formable Cable
- 1 Shield(s)

Features

Description

Formable semi-rigid coax is a hand formable version of standard semi-rigid that does not require complicated and costly pre-formed cable assemblies. Because the dimensions and electrical characteristics are so closely matched to semi-rigid coax, standard semi-rigid connectors can be used. The tin soaked copper braid outer shield provides excellent RF shielding. FEP Jacket reduces the chance of shorting exposed contacts or circuit conductors.

Electrical Specifications

Description	Minimum	Typical	Maximum	Units
Frequency Range	DC		34	GHz
Impedance		50		Ohms
Velocity of Propagation		70		%
Time Delay		1.43 4.69		ns/ft ns/m
Shielding Effectiveness	100			dB
Operating Voltage (AC)			1,900	Vrms
Dielectric Withstanding Voltage (AC)			3,000	Vrms
Inner Conductor DC Resistance			8.23	Ohms/1000ft
Nominal Capacitance		29 [95.14]		pF/ft [pF/m]
Insulation Resistance	1,524			MOhms/1000ft

Performance by Frequency Band

Description	F1	F2	F3	F4	F5	Units
Frequency	0.5	1	5	10	20	GHz
Attenuation, Typ	8.23	12.5	32	48.158	73.152	dB/100ft
	27	41.01	104.99	158	240	dB/100m
Input Power (CW), Max	436.5	303.4	126.7	85.5	56.6	Watts

Mechanical Specifications

Diameter	0.161 in [4.09 mm]
Weight	0.032 lbs/ft [0.05 Kg/m]

Click the following link (or enter part number in "SEARCH" on website) to obtain additional part information including price, inventory and certifications: [Formable PE-SR402FLJ Coax Cable with Tinned Copper Braid Outer Conductor and Black FEP Jacket PE-SR402FLJ](#)



Formable 141 Semirigid Coax Cable with Tinned Braid Outer Conductor and Black FEP Jacket

RF Cables Technical Data Sheet

PE-SR402FLJ

Min. Bend Radius (Installation)	0.315 in [8 mm]
Min. Bend Radius (Repeated)	1.575 in [40.01 mm]

Construction Specifications

Description	Material and Plating	Diameter
Inner Conductor	Copper, Silver1	0.036 in 0.91 mm
Conductor Type	Solid	
Dielectric	PTFE	0.117 in 2.97 mm
First Shield	Tinned Copper Braid	0.139 in 3.53 mm
Jacket	FEP, Black	0.161 in [4.09 mm]

Environmental Specifications

Temperature

Operating Range	-65 to +150 deg C
Storage Range	10 to +35 deg C

Compliance Certifications (see [product page](#) for current document)

Plotted and Other Data

Notes:

Formable 141 Semirigid Coax Cable with Tinned Braid Outer Conductor and Black FEP Jacket from Pasternack Enterprises has same day shipment for domestic and International orders. Our RF, microwave and millimeter wave products maintain a 99.4% availability and are part of the broadest selection in the industry.

Click the following link (or enter part number in "SEARCH" on website) to obtain additional part information including price, inventory and certifications: [Formable PE-SR402FLJ Coax Cable with Tinned Copper Braid Outer Conductor and Black FEP Jacket PE-SR402FLJ](#)

URL: <https://www.pasternack.com/50-ohm-formable-141-semirigid-tinned-braid-outer-conductor-fep-jacket-black-pe-sr402flj-p.aspx>

The information contained in this document is accurate to the best of our knowledge and representative of the part described herein. It may be necessary to make modifications to the part and/or the documentation of the part, in order to implement improvements. Pasternack reserves the right to make such changes as required. Unless otherwise stated, all specifications are nominal. Pasternack does not make any representation or warranty regarding the suitability of the part described herein for any particular purpose, and Pasternack does not assume any liability arising out of the use of any part or documentation.

PE-SR402FLJ CAD Drawing

Formable 141 Semirigid Coax Cable with Tinned Braid
Outer Conductor and Black FEP Jacket



NOTES:
 1. UNLESS OTHERWISE SPECIFIED ALL DIMENSIONS ARE NOMINAL.
 2. ALL SPECIFICATIONS ARE SUBJECT TO CHANGE WITHOUT NOTICE AT ANY TIME.
 3. DIMENSIONS ARE IN INCHES [mm].

DWG TITLE
PE-SR402FLJ

41742

SIZE A

SCALE N/A

CAD FILE 111716

FSCM NO. 53919

PE PASTERNAK
 THE ENGINEER'S RF SOURCE
 Pasternack Enterprises, Inc.
 P.O. Box 16759 | Irvine | CA | 92623
 Phone: (949) 261-1920 | Fax: (949) 261-7451
 Website: www.pasternack.com | E-Mail: sales@pasternack.com