

MATERIALS

BODY	BRASS NICKEL PLATED
CONTACT	GOLD PLATED
INSULATOR	PTFE

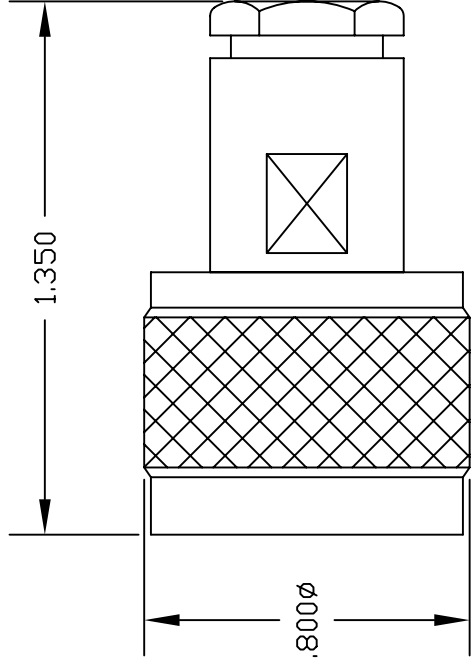

ASSEMBLY PROCEDURES

1. SLIDE CLAMP NUT (1), WASHER (2) & GASKET (3) OVER CABLE. STRIP CABLE AS SHOWN. DO NOT NICK BRAID WHILE CUTTING JACKET. TAPER END OF BRAID TO PERMIT ASSEMBLY OF BRAID CLAMP (4). SLIDE BRAID CLAMP (4) OVER BRAID & SEAT AGAINST CABLE.

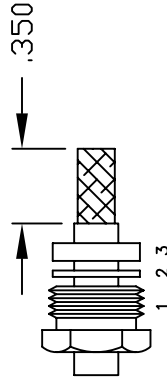

2. FORM BRAID OVER CLAMP NUT (4). TRIM BRAID BACK TO SHOULDER. CUT DIELECTRIC & CENTER CONDUCTOR TO DIMENSION SHOWN. DO NOT NICK CENTER CONDUCTOR. SOLDER CONTACT TO CENTER CONDUCTOR. REMOVE EXCESS SOLDER. DO NOT OVER HEAT DIELECTRIC. INSERT CABLE ASSEMBLY INTO BODY & TIGHTEN.

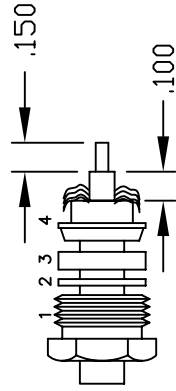

NOTE: INSERT PTFE BEFORE CONTACT. WITH OPEN END SLIDE OVER CENTER CONDUCTOR RESTING AGAINST DIELECTRIC.



PASTERNAK ENTERPRISES, INC.
 P.O. BOX 16759, IRVINE, CA 92623
 PHONE (949) 261-1920 FAX (949) 261-7451
 WEB ADDRESS: www.pasternack.com
 E-MAIL ADDRESS: sales@pasternack.com
COAXIAL & FIBER OPTICS

DES. N MALE, CLAMP ATTACHMENT FOR RG174, RG188 & RG316

DWG TITLE

PE4224

REV. -	FSCM NO. 53919	CAD FILE	042309	SCALE	N/A	SIZE	A	147
--------	----------------	----------	--------	-------	-----	------	---	-----

NOTES:

1. UNLESS OTHERWISE SPECIFIED ALL DIMENSIONS ARE NOMINAL.
2. ALL SPECIFICATIONS ARE SUBJECT TO CHANGE WITHOUT NOTICE AT ANY TIME.
3. DIMENSIONS ARE IN INCHES.



TNC Male Right Angle Connector Clamp/Solder Attachment For RG174, RG316, RG188

RF Connectors
Technical Data Sheet

PE4454

Configuration

- TNC Male Connector
- 50 Ohms
- Right Angle Body Geometry
- Connector Interface Types: RG174, RG316, RG188

Applications

- General Purpose Test
- Custom Cable Assemblies

Description

Pasternack's PE4454 TNC male right angle connector with clamp/solder attachment for RG174, RG316 and RG188 is part of our full line of RF components available for same-day shipping. Its right angle body geometry allows for easier connections in tight spaces.

Our TNC male right angle connector PE4454 datasheet specifications and drawing with dimensions are shown below in this PDF. Pasternack's broad catalog of RF, microwave and millimeter wave connectors allows designers to configure and customize their signal connections however they like. Whether the need is to provide an I/O for a board design, or simply create a custom cable assembly configuration, Pasternack has the right connector for the job. Pasternack can also expertly build your custom cable assemblies for you and ship same-day.

Mechanical Specifications

Weight 0.096 lbs [43.54 g]

Material Specifications

Description	Material	Plating
Body	Brass	Nickel

Environmental Specifications

Compliance Certifications (see [product page](#) for current document)

Plotted and Other Data

Notes:

Click the following link (or enter part number in "SEARCH" on website) to obtain additional part information including price, inventory and certifications: [TNC Male Right Angle Connector Clamp/Solder Attachment For RG174, RG316, RG188 PE4454](#)



TNC Male Right Angle Connector Clamp/Solder Attachment For RG174, RG316, RG188

RF Connectors
Technical Data Sheet

PE4454

Assembly Instruction

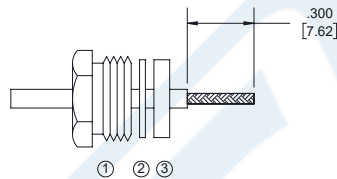

1. SLIDE CLAMP NUT ①, WASHER ② & GASKET ③ OVER CABLE. STRIP CABLE AS SHOWN. DO NOT NICK BRAID WHILE CUTTING JACKET. TAPER END OF BRAID TO PERMIT ASSEMBLY OF CLAMP.

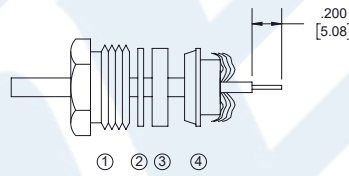

2. SLIDE BRAID CLAMP ④ OVER BRAID & SEAT AGAINST CABLE. FORM BRAID OVER CLAMP NUT. TRIM BRAID BACK TO SHOULDER. CUT DIELECTRIC & CENTER CONDUCTOR TO DIMENSION SHOWN. DO NOT NICK CENTER CONDUCTOR.

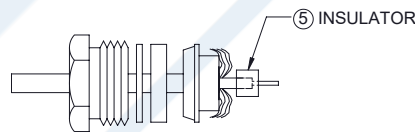

3. SLIDE INSULATOR ⑤ AGAINST THE BRAID CLAMP. SOFT SOLDER CONTACT ⑥ TO CENTER CONDUCTOR. REMOVE EXCESS SOLDER. DO NOT OVER HEAT DIELECTRIC. INSERT CABLE ASSEMBLY INTO BODY ⑦ & TIGHTEN BY CLAMP NUT ONLY.

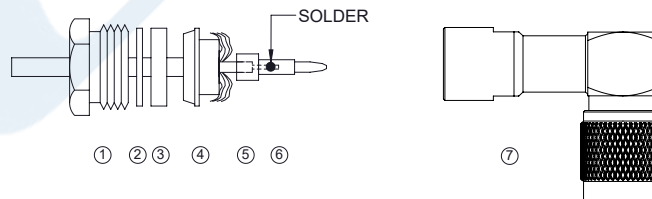

Click the following link (or enter part number in "SEARCH" on website) to obtain additional part information including price, inventory and certifications: [TNC Male Right Angle Connector Clamp/Solder Attachment For RG174, RG316, RG188 PE4454](#)



TNC Male Right Angle Connector Clamp/Solder Attachment For RG174, RG316, RG188

RF Connectors Technical Data Sheet

PE4454

TNC Male Right Angle Connector Clamp/Solder Attachment For RG174, RG316, RG188 from Pasternack Enterprises has same day shipment for domestic and International orders. Our RF, microwave and millimeter wave products maintain a 99.4% availability and are part of the broadest selection in the industry.

Click the following link (or enter part number in "SEARCH" on website) to obtain additional part information including price, inventory and certifications: [TNC Male Right Angle Connector Clamp/Solder Attachment For RG174, RG316, RG188 PE4454](https://www.pasternack.com/tnc-male-standard-rg174-rg316-rg188-connector-pe4454-p.aspx)

URL: <https://www.pasternack.com/tnc-male-standard-rg174-rg316-rg188-connector-pe4454-p.aspx>

The information contained in this document is accurate to the best of our knowledge and representative of the part described herein. It may be necessary to make modifications to the part and/or the documentation of the part, in order to implement improvements. Pasternack reserves the right to make such changes as required. Unless otherwise stated, all specifications are nominal. Pasternack does not make any representation or warranty regarding the suitability of the part described herein for any particular purpose, and Pasternack does not assume any liability arising out of the use of any part or documentation.

PE4454 CAD Drawing

TNC Male Right Angle Connector Clamp/Solder Attachment For RG174, RG316, RG188

REV.	DESCRIPTION	DATE	APPROVED
A	PCR PE4454	3/24/2020	S.ELLIS

REVISIONS	
REV.	DESCRIPTION
A	PCR PE4454

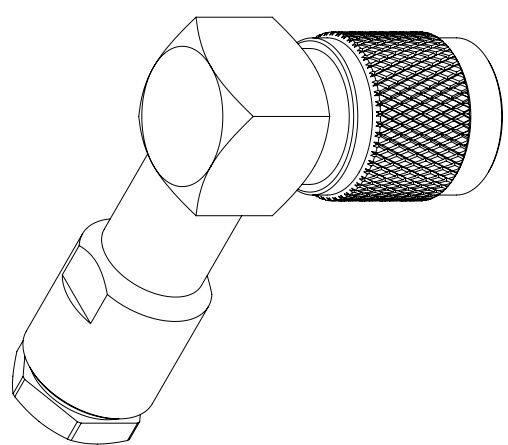
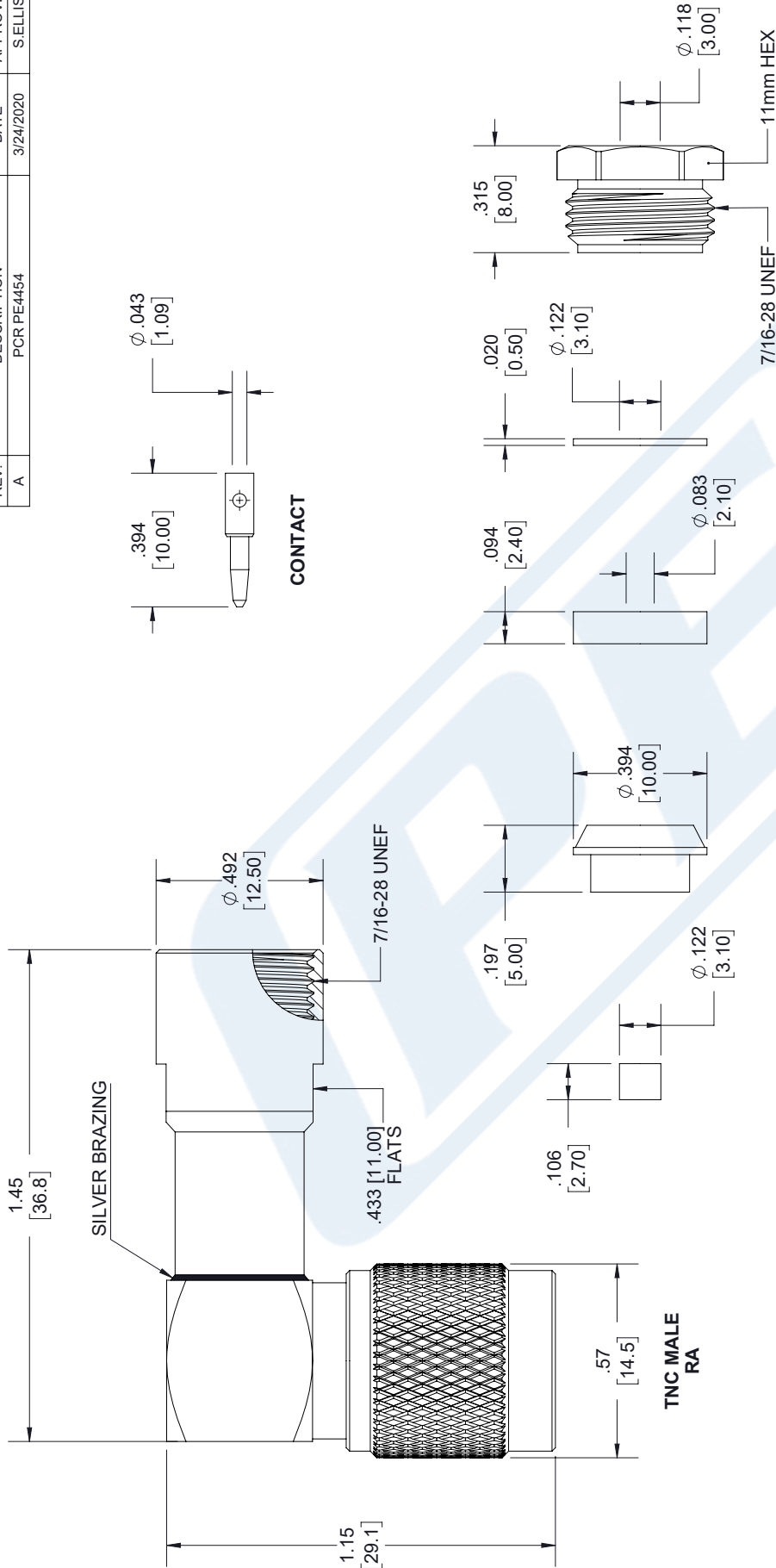

PE PASTERNAK
an INFINITO brand

Pasternack Enterprises, Inc.
P. O. Box 16759, Irvine, CA 92623.
Phone: 1.949.261.1920 | 1.866.727.8376
Fax: 1.949.261.7451
Website: www.pasternack.com
E-mail: sales@pasternack.com

THIRD-ANGLE PROJECTION

THE INFORMATION AND DESIGN IN THIS DOCUMENT IS THE PROPERTY OF PASTERNAK CORPORATION. ALL RIGHTS RESERVED.

SHEET 1 OF 2
SCALE N/A

UNLESS OTHERWISE SPECIFIED LEADING DIMENSIONS ARE INCHES DIMENSIONS IN [] ARE MILLIMETERS

TOLERANCES:
 .X = ±.2 [5.08] FRACTIONS ± 1/32
 .XX = ±.02 [.51] ANGLES ± 1°
 .XXX = ±.005 [.13] CABLE LENGTH (L) TOLERANCES:
 L ≤ 12 [305] = +1 [25] / -0
 12 [305] < L ≤ 60 [1524] = +2 [51] / -0
 60 [1524] < L ≤ 120 [3048] = +4 [102] / -0
 120 [3048] < L ≤ 300 [7620] = +6 [152] / -0
 300 [7620] < L = +5% / L / -0

ALL DIMENSIONS SHOWN ARE FOR REFERENCE ONLY.

SIZE CAGE CODE DRAWN BY ITEM NO. REV

A 53919 K.DANG PE4454 A

THESE COMMODITIES, TECHNOLOGY OR SOFTWARE WERE EXPORTED FROM THE UNITED STATES IN ACCORDANCE WITH THE EXPORT ADMINISTRATION REGULATIONS. DIVERSION CONTRARY TO U.S. LAW PROHIBITED.

Flexible RG174 Coax Cable Single Shielded with Black PVC Jacket

RF Cables Technical Data Sheet

Times Microwave Systems Coax Cable Specification

Configuration

- Flexible Cable
- 1 Shield(s)

Electrical Specifications

Description	Minimum	Typical	Maximum	Units
Frequency Range	DC		1,000	MHz
Impedance		50		Ohms
Velocity of Propagation		66		%
Nominal Capacitance		31.08 [101.97]		pF/ft [pF/m]

Performance by Frequency Band

Description	F1	F2	F3	F4	F5	Units
Frequency	100	400	1,000			MHz
Attenuation, Typ	8.4	19	32			dB/100ft dB/100m
	27.56	62.34	104.99			

Mechanical Specifications

Diameter	0.11 in [2.79 mm]
Weight	0.009 lbs/ft [0.01 Kg/m]

Construction Specifications

Description	Material and Plating	Diameter
Inner Conductor	Copper Clad Steel, 7 Strands	0.019 in [0.48 mm]
Conductor Type	Stranded	
Dielectric	PE	0.06 in [1.52 mm]
First Shield	Tinned Copper Braid	0.078 in [1.98 mm]

Click the following link (or enter part number in "SEARCH" on website) to obtain additional part information including price, inventory and certifications: [Flexible RG174 Coax Cable Single Shielded with Black PVC Jacket RG174A/U](#)

Flexible RG174 Coax Cable Single
Shielded with Black PVC Jacket

RF Cables
Technical Data Sheet

Jacket	PVC, Black	0.11 in [2.79 mm]
--------	------------	-------------------

Environmental Specifications

Temperature

Operating Range

-40 to +80 deg C

Compliance Certifications (see [product page](#) for current document)

Plotted and Other Data

Notes:

Flexible RG174 Coax Cable Single Shielded with Black PVC Jacket from Pasternack Enterprises has same day shipment for domestic and International orders. Our RF, microwave and millimeter wave products maintain a 99.4% availability and are part of the broadest selection in the industry.

Click the following link (or enter part number in "SEARCH" on website) to obtain additional part information including price, inventory and certifications: [Flexible RG174 Coax Cable Single Shielded with Black PVC Jacket RG174A/U](#)

URL: <https://www.pasternack.com/flexible-0.100-rg174-50-ohm-coax-cable-pvc-jacket-rg174a-u-p.aspx>

The information contained in this document is accurate to the best of our knowledge and representative of the part described herein. It may be necessary to make modifications to the part and/or the documentation of the part, in order to implement improvements. Pasternack reserves the right to make such changes as required. Unless otherwise stated, all specifications are nominal. Pasternack does not make any representation or warranty regarding the suitability of the part described herein for any particular purpose, and Pasternack does not assume any liability arising out of the use of any part or documentation.

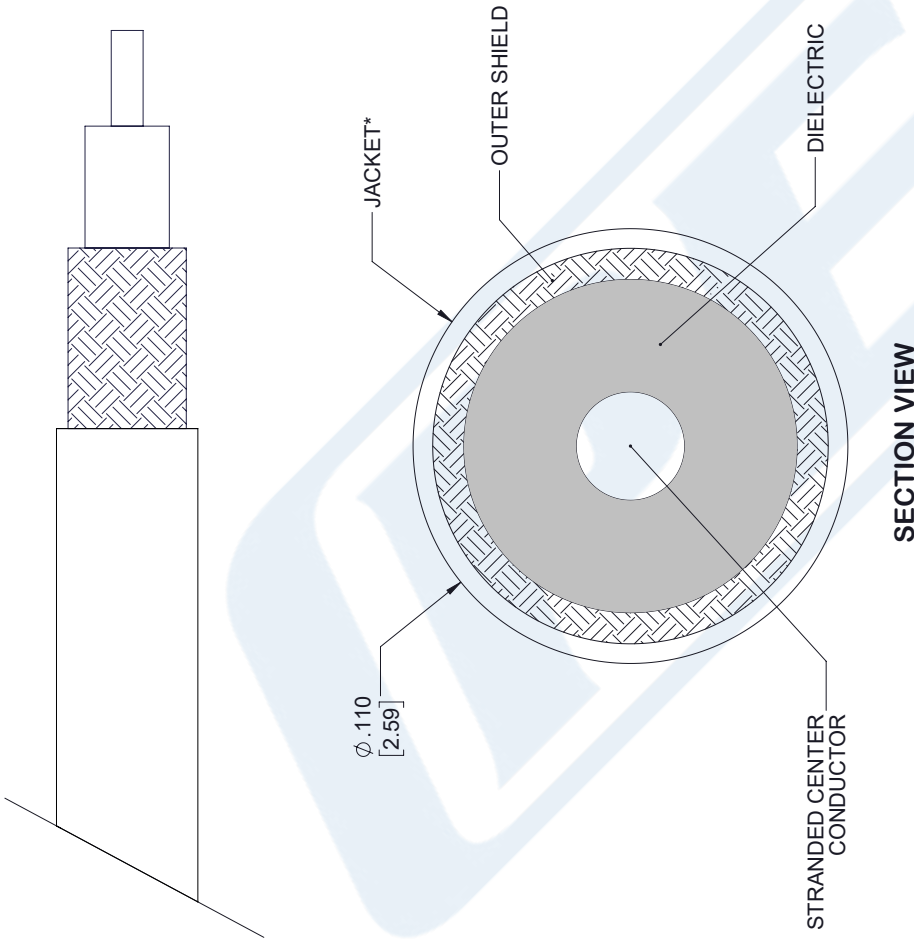

NOTE:

*STANDARD TOLERANCES APPLY ONLY TO DIMENSIONS IN INCHES

STANDARD	TOLERANCES
.X	± 0.2
.XX	± 0.01
.XXX	± 0.005

NOTES:
 1. UNLESS OTHERWISE SPECIFIED ALL DIMENSIONS ARE NOMINAL.
 2. ALL SPECIFICATIONS ARE SUBJECT TO CHANGE WITHOUT NOTICE AT ANY TIME
 3. DIMENSIONS ARE IN INCHES [mm].

DWG TITLE
RG174A/U

CAGE CODE **53919**

PASTERNAK®
 THE ENGINEER'S RF SOURCE
 Pasternack Enterprises, Inc.
 P.O. Box 16759 | Irvine | CA | 92623
Phone: (949) 261-1920 | **Fax:** (949) 261-7451
Website: www.pasternack.com | **E-Mail:** sales@pasternack.com

CAD FILE 05/25/18

SCALE N/A

SIZE A

7361