



## 4.3-10 Male Low PIM Push-On Connector Solder Attachment for PE-1/2SFHC, IP67 Rated

### RF Connectors Technical Data Sheet

PE45300

#### Configuration

- Push-On 4.3-10 Male Connector
- Straight Body Geometry
- PE-1/2SFHC Interface Type
- Solder/Solder Attachment
- Low PIM Design

#### Features

- Max. Operating Frequency 6 GHz
- Excellent VSWR of 1.12:1
- PIM levels lower than -166 dBc
- Silver Plated Brass Contact
- IP 67 (Mated)
- Low Coupling Torque
- Corrosion Resistant Tri-Metal Finish
- Low-PIM rating of -166 dBc

#### Applications

- General Purpose Test
- Wireless Communications
- Custom Cable Assemblies
- Low PIM Applications
- Mobile Communications Systems
- Base Stations
- Distributed Antenna Systems (DAS)
- Small Cells
- Feeder Cables

#### Description

Pasternack's PE45300 4.3-10 male push-on connector with solder/solder attachment for PE-1/2SFHC is part of our full line of RF components available for same-day shipping. Our 4.3-10 male connector operates up to a maximum frequency of 6 GHz and offers excellent VSWR of 1.12:1. The 4.3-10 male connector also has low passive intermodulation of -166 dBc. The connector has an IP67 rating to protect against dust and temporary moisture protection under immersion conditions.

Our 4.3-10 male connector PE45300 datasheet specifications and drawing with dimensions are shown below in this PDF. Pasternack's broad catalog of RF, microwave and millimeter wave connectors allows designers to configure and customize their signal connections however they like. Whether the need is to provide an I/O for a board design, or simply create a custom cable assembly configuration, Pasternack has the right connector for the job. Pasternack can also expertly build your custom cable assemblies for you and ship same-day.

#### Electrical Specifications

Description	Minimum	Typical	Maximum	Units
Frequency Range	DC		6	GHz
VSWR			1.12:1	
Insertion Loss			0.13	dB
Passive Intermodulation		-166		dBc
Operating Voltage (AC)			1,000	Vrms
Dielectric Withstanding Voltage (AC)			2,500	Vrms
Insulation Resistance	5,000			MOhms

Click the following link (or enter part number in "SEARCH" on website) to obtain additional part information including price, inventory and certifications: [4.3-10 Male Low PIM Push-On Connector Solder Attachment for PE-1/2SFHC, IP67 Rated PE45300](#)



4.3-10 Male Low PIM Push-On Connector Solder Attachment for PE-1/2SFHC, IP67 Rated

RF Connectors Technical Data Sheet

PE45300

**Mechanical Specifications**

**Size**

Length	1.06 in [26.92 mm]
Width/Dia.	1 in [25.40 mm]
Weight	0.073 lbs [33.11 g]
Mating Cycles	100 Cycles

**Material Specifications**

Description	Material	Plating
Contact	Brass	Silver
Insulation	PTFE	
Body	Brass	Tri-Metal
Coupling Nut	Brass	Tri-Metal
Gasket	EPDM Rubber	

**Environmental Specifications**

**Temperature**

Operating Range	-55 to +90 deg C
Ingress Protection (IP) Rating	IP 67 (Mated)

Click the following link (or enter part number in "SEARCH" on website) to obtain additional part information including price, inventory and certifications: [4.3-10 Male Low PIM Push-On Connector Solder Attachment for PE-1/2SFHC, IP67 Rated PE45300](#)



## 4.3-10 Male Low PIM Push-On Connector Solder Attachment for PE-1/2SFHC, IP67 Rated

### RF Connectors Technical Data Sheet

PE45300

**Compliance Certifications** (see [product page](#) for current document)

#### Plotted and Other Data

Notes:

4.3-10 Male Low PIM Push-On Connector Solder Attachment for PE-1/2SFHC, IP67 Rated from Pasternack Enterprises has same day shipment for domestic and International orders. Our RF, microwave and millimeter wave products maintain a 99.4% availability and are part of the broadest selection in the industry.

Click the following link (or enter part number in "SEARCH" on website) to obtain additional part information including price, inventory and certifications: [4.3-10 Male Low PIM Push-On Connector Solder Attachment for PE-1/2SFHC, IP67 Rated PE45300](#)

URL: <https://www.pasternack.com/4.3-10-male-pe-1-2sfhc-connector-pe45300-p.aspx>

The information contained in this document is accurate to the best of our knowledge and representative of the part described herein. It may be necessary to make modifications to the part and/or the documentation of the part, in order to implement improvements. Pasternack reserves the right to make such changes as required. Unless otherwise stated, all specifications are nominal. Pasternack does not make any representation or warranty regarding the suitability of the part described herein for any particular purpose, and Pasternack does not assume any liability arising out of the use of any part or documentation.

# PE45300 CAD Drawing

4.3-10 Male Low PIM Push-On Connector Solder Attachment for PE-1/2SFHC, IP67 Rated

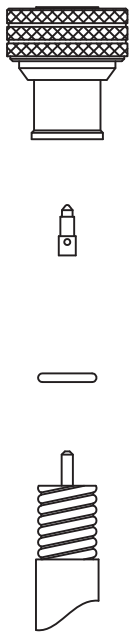

CABLE INSULATOR CONTACT BODY

### ASSEMBLY PROCEDURES

1. STRIP CABLE AS SHOWN, CHAMFER CENTER CONDUCTOR & DEBURR CABLE.

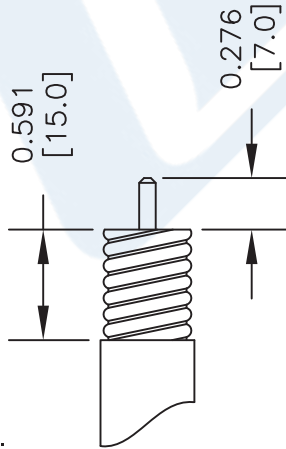

2. INSERT INSULATOR CLIP, INSERT CENTER CONTACT AND SOLDER. WRAP THE CABLE BY SOLDER WIRE (Dia 1.2mm).



3. PUSH THE CONNECTOR BODY INTO THE CABLE, UNTIL IT STOPS. SOLDER THE CONNECTOR BODY WITH CABLE.

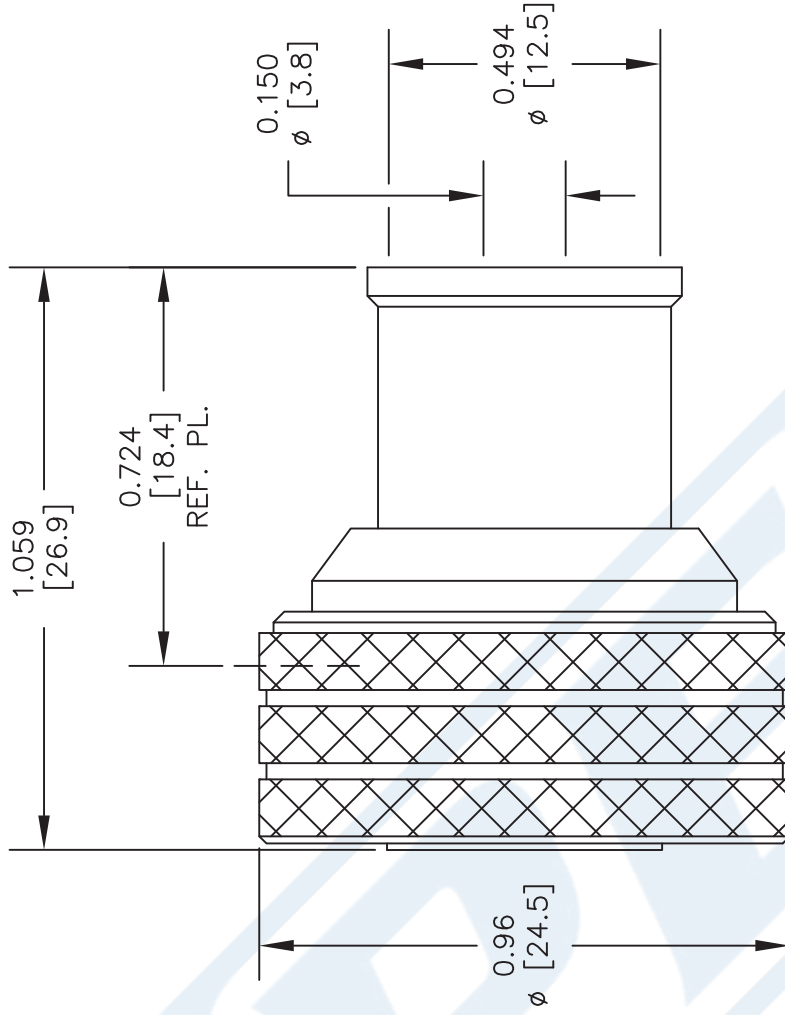
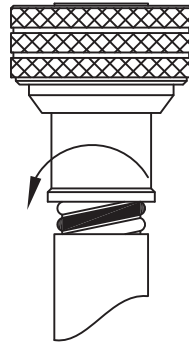

### STANDARD TOLERANCES

.X ±0.2  
.XX ±0.1  
.XXX ±0.05

\*STANDARD TOLERANCES APPLY ONLY TO DIMENSIONS IN INCHES

### NOTES:

1. UNLESS OTHERWISE SPECIFIED ALL DIMENSIONS ARE NOMINAL.
2. ALL SPECIFICATIONS ARE SUBJECT TO CHANGE WITHOUT NOTICE AT ANY TIME.
3. DIMENSIONS ARE IN INCHES [mm].

DWG TITLE

**PE45300**

CAGE CODE 53919

CAD FILE 011917

SCALE N/A

SIZE A

2233

**(PE) PASTERNAK®**  
THE ENGINEER'S RF SOURCE

Pasternack Enterprises, Inc.  
P.O. Box 16759 | Irvine | CA | 92623  
Phone: (949) 261-1920 | Fax: (949) 261-7451  
Website: www.pasternack.com | E-Mail: sales@pasternack.com



## 4.3-10 Male Low PIM Connector Solder Attachment for PE-1/2SFHC, IP67 Rated

### RF Connectors Technical Data Sheet

PE45299

#### Configuration

- 4.3-10 Male Connector
- Straight Body Geometry
- PE-1/2SFHC Interface Type
- Solder/Solder Attachment
- 22 mm Hex
- Low PIM Design

#### Features

- Max. Operating Frequency 6 GHz
- Excellent VSWR of 1.15:1
- PIM levels lower than -166 dBc
- Silver Plated Brass Contact
- IP 67 (Mated)
- Low Coupling Torque
- Corrosion Resistant Tri-Metal Finish
- Low-PIM rating of -166 dBc

#### Applications

- General Purpose Test
- Wireless Communications
- Custom Cable Assemblies
- Low PIM Applications
- Mobile Communications Systems
- Base Stations
- Distributed Antenna Systems (DAS)
- Small Cells
- Feeder Cables

#### Description

Pasternack's PE45299 4.3-10 male connector with solder/solder attachment for PE-1/2SFHC is part of our full line of RF components available for same-day shipping. Our 4.3-10 male connector operates up to a maximum frequency of 6 GHz and offers excellent VSWR of 1.15:1. The 4.3-10 male connector also has low passive intermodulation of -166 dBc. The connector has an IP67 rating to protect against dust and temporary moisture protection under immersion conditions.

Our 4.3-10 male connector PE45299 datasheet specifications and drawing with dimensions are shown below in this PDF. Pasternack's broad catalog of RF, microwave and millimeter wave connectors allows designers to configure and customize their signal connections however they like. Whether the need is to provide an I/O for a board design, or simply create a custom cable assembly configuration, Pasternack has the right connector for the job. Pasternack can also expertly build your custom cable assemblies for you and ship same-day.

#### Electrical Specifications

Description	Minimum	Typical	Maximum	Units
Frequency Range	DC		6	GHz
VSWR			1.15:1	
Insertion Loss			0.13	dB
Passive Intermodulation		-166		dBc
Operating Voltage (AC)			1,000	Vrms
Dielectric Withstanding Voltage (AC)			2,500	Vrms
Insulation Resistance	5,000			MOhms

Click the following link (or enter part number in "SEARCH" on website) to obtain additional part information including price, inventory and certifications: [4.3-10 Male Low PIM Connector Solder Attachment for PE-1/2SFHC, IP67 Rated PE45299](#)



4.3-10 Male Low PIM Connector Solder Attachment for PE-1/2SFHC, IP67 Rated

RF Connectors Technical Data Sheet

PE45299

**Mechanical Specifications**

**Size**

Length	1.1 in [27.94 mm]
Width/Dia.	0.96 in [24.38 mm]
Weight	0.067 lbs [30.39 g]
Mating Cycles	100 Cycles

**Material Specifications**

Description	Material	Plating
Contact	Brass	Silver
Insulation	PTFE	
Body	Brass	Tri-Metal
Coupling Nut	Brass	Tri-Metal
Gasket	EPDM Rubber	

**Environmental Specifications**

**Temperature**

Operating Range	-55 to +90 deg C
Ingress Protection (IP) Rating	IP 67 (Mated)

Click the following link (or enter part number in "SEARCH" on website) to obtain additional part information including price, inventory and certifications: [4.3-10 Male Low PIM Connector Solder Attachment for PE-1/2SFHC, IP67 Rated PE45299](#)



## 4.3-10 Male Low PIM Connector Solder Attachment for PE-1/2SFHC, IP67 Rated

### RF Connectors Technical Data Sheet

PE45299

**Compliance Certifications** (see [product page](#) for current document)

#### Plotted and Other Data

Notes:

4.3-10 Male Low PIM Connector Solder Attachment for PE-1/2SFHC, IP67 Rated from Pasternack Enterprises has same day shipment for domestic and International orders. Our RF, microwave and millimeter wave products maintain a 99.4% availability and are part of the broadest selection in the industry.

Click the following link (or enter part number in "SEARCH" on website) to obtain additional part information including price, inventory and certifications: [4.3-10 Male Low PIM Connector Solder Attachment for PE-1/2SFHC, IP67 Rated PE45299](#)

URL: <https://www.pasternack.com/4.3-10-male-pe-1-2sfhc-connector-pe45299-p.aspx>

The information contained in this document is accurate to the best of our knowledge and representative of the part described herein. It may be necessary to make modifications to the part and/or the documentation of the part, in order to implement improvements. Pasternack reserves the right to make such changes as required. Unless otherwise stated, all specifications are nominal. Pasternack does not make any representation or warranty regarding the suitability of the part described herein for any particular purpose, and Pasternack does not assume any liability arising out of the use of any part or documentation.

# PE45299 CAD Drawing

4.3-10 Male Low PIM Connector Solder Attachment for PE-1/2SFHC, IP67 Rated

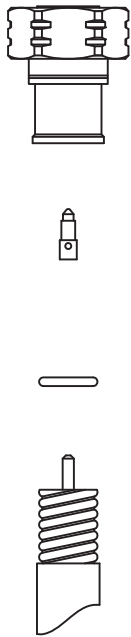

CABLE INSULATOR CONTACT BODY

### ASSEMBLY PROCEDURES

1. STRIP CABLE AS SHOWN, CHAMFER CENTER CONDUCTOR & DEBURR CABLE.

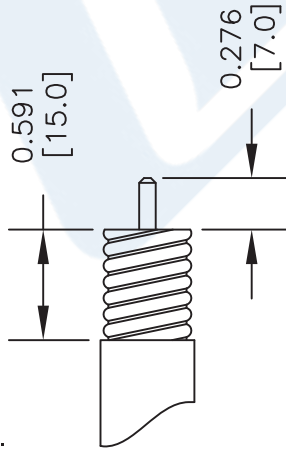

2. INSERT INSULATOR CLIP. INSERT CENTER CONTACT AND SOLDER. WRAP THE CABLE BY SOLDER WIRE (Dia 1.2mm).



3. PUSH THE CONNECTOR BODY INTO THE CABLE, UNTIL IT STOPS. SOLDER THE CONNECTOR BODY WITH CABLE.

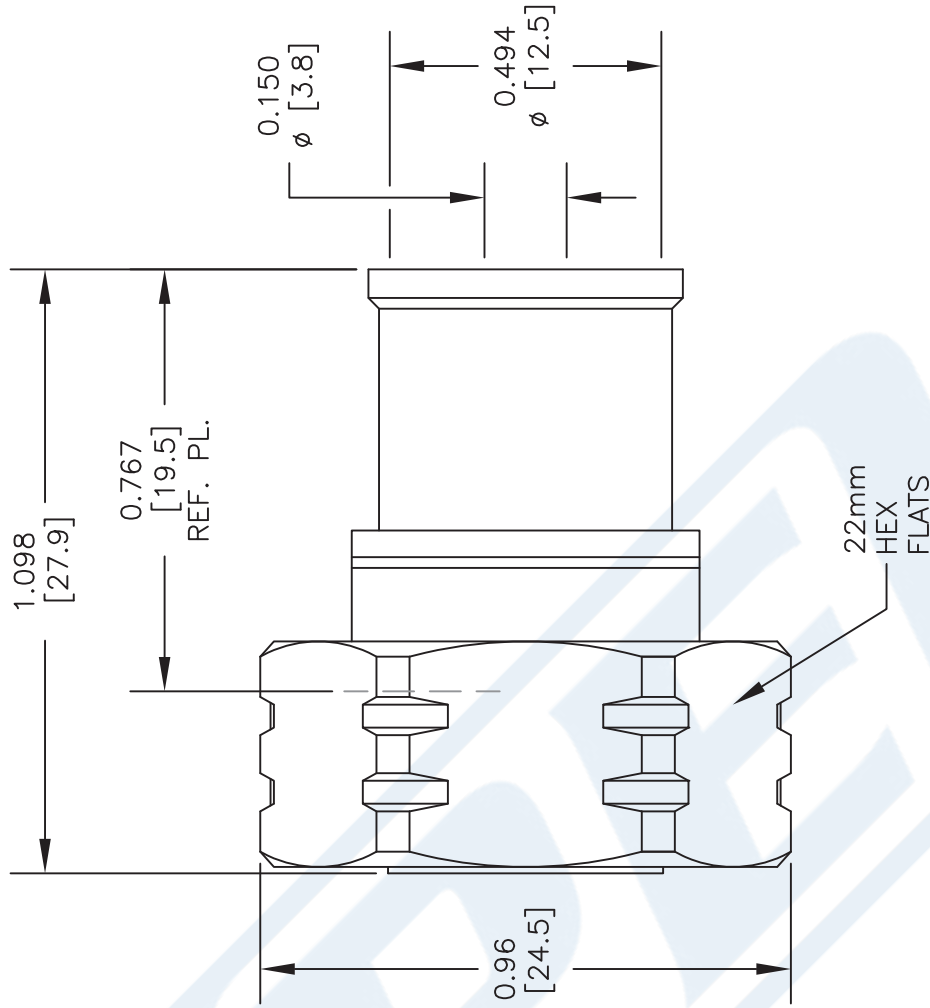
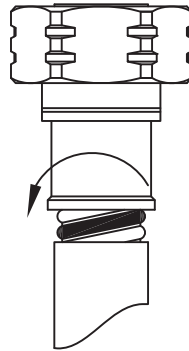

### STANDARD TOLERANCES

.X ±0.2  
.XX ±0.1  
.XXX ±0.05

\*STANDARD TOLERANCES APPLY ONLY TO DIMENSIONS IN INCHES

### NOTES:

1. UNLESS OTHERWISE SPECIFIED ALL DIMENSIONS ARE NOMINAL.
2. ALL SPECIFICATIONS ARE SUBJECT TO CHANGE WITHOUT NOTICE AT ANY TIME.
3. DIMENSIONS ARE IN INCHES [mm].

DWG TITLE

**PE45299**

CAGE CODE 53919

CAD FILE 011917

SCALE N/A

SIZE A

2233



THE ENGINEER'S RF SOURCE  
Pasternack Enterprises, Inc.  
P.O. Box 16759 | Irvine | CA | 92623

Phone: (949) 261-1920 | Fax: (949) 261-7451

Website: www.pasternack.com | E-Mail: sales@pasternack.com



## Low Loss 1/2 inch Superflexible Corrugated Coax Cable with Black PE Jacket

### RF Cables Technical Data Sheet

PE-1/2SFHC

#### Configuration

- Low Loss Corrugated Cable
- 1 Shield(s)

#### Features

- Low Passive Intermodulation
- Solid copper outer conductor provides the highest possible RF shielding
- Superflexible helically corrugated copper outer conductor enables a small bending radius
- Excellent return loss performance
- Highly foamed dielectric provides low attenuation

#### Description

Our corrugated cables and Low PIM connector combinations result in cable assemblies with excellent Passive Intermodulation performance. Solid copper outer conductors provide the highest possible RF shielding. This Superflexible cable features excellent return loss performance. The highly foamed dielectric and optimized dimensions of these cables result in excellent low attenuation values. The Superflexible helically corrugated copper outer conductor allows for a small bending radius.

#### Electrical Specifications

Description	Minimum	Typical	Maximum	Units
Frequency Range	DC		10.2	GHz
Cutoff Frequency		13		GHz
Impedance		50		Ohms
Velocity of Propagation		82		%
Shielding Effectiveness	120			dB
Operating Voltage (AC)			1,000	Vrms
Dielectric Withstanding Voltage (AC)			2,500	Vrms
Inner Conductor DC Resistance			0.91	Ohms/1000ft
Outer Conductor DC Resistance			1.08	Ohms/1000ft
Nominal Capacitance		25.3 [83.01]		pF/ft [pF/m]
Nominal Inductance		0.059 [0.19]		uH/ft [uH/m]

Click the following link (or enter part number in "SEARCH" on website) to obtain additional part information including price, inventory and certifications: [Low Loss 1/2 inch Superflexible Corrugated Coax Cable with Black PE Jacket PE-1/2SFHC](#)



## Low Loss 1/2 inch Superflexible Corrugated Coax Cable with Black PE Jacket

### RF Cables Technical Data Sheet

PE-1/2SFHC

#### Performance by Frequency Band

Description	F1	F2	F3	F4	F5	Units
Frequency	0.1	0.45	0.9	1	1.8	GHz
Attenuation, Typ	1.01	2.22	3.22	3.41	4.72	dB/100ft
	3.31	7.28	10.56	11.19	15.49	dB/100m
Input Power (CW), Max	2,590	1,180	810	770	560	Watts

Description	F6	F7	F8	F9	F10	Units
Frequency	2	3	4	5	6	GHz
Attenuation, Typ	5.01	6.3	7.44	8.48	9.44	dB/100ft
	16.44	20.67	24.41	27.82	30.97	dB/100m
Input Power (CW), Max	530	420	350	31	280	Watts

#### Mechanical Specifications

Diameter	0.519 in [13.18 mm]
Weight	0.132 lbs/ft [0.2 Kg/m]
Number of Bends, Min	20
Min. Bend Radius (Installation)	0.6 in [15.24 mm]
Min. Bend Radius (Repeated)	1.18 in [29.97 mm]
Tensile Strength	79 lbs [35.83 kg]

#### Construction Specifications

Description	Material and Plating	Diameter
Inner Conductor	Copper Clad Aluminum <sup>1</sup>	0.141 in 3.58 mm
Conductor Type	Solid	
Dielectric	PE (F)	0.378 in 9.6 mm
Outer Conductor	Helically Corrugated Copper Tube	0.468 in 11.89 mm
Jacket	PE, Black	0.519 in [13.18 mm]

Click the following link (or enter part number in "SEARCH" on website) to obtain additional part information including price, inventory and certifications: [Low Loss 1/2 inch Superflexible Corrugated Coax Cable with Black PE Jacket PE-1/2SFHC](#)



## Low Loss 1/2 inch Superflexible Corrugated Coax Cable with Black PE Jacket

### RF Cables Technical Data Sheet

PE-1/2SFHC

#### Environmental Specifications

##### Temperature

Operating Range

-55 to +85 deg C

**Compliance Certifications** (see [product page](#) for current document)

#### Plotted and Other Data

Notes:

Low Loss 1/2 inch Superflexible Corrugated Coax Cable with Black PE Jacket from Pasternack Enterprises has same day shipment for domestic and International orders. Our RF, microwave and millimeter wave products maintain a 99.4% availability and are part of the broadest selection in the industry.

Click the following link (or enter part number in "SEARCH" on website) to obtain additional part information including price, inventory and certifications: [Low Loss 1/2 inch Superflexible Corrugated Coax Cable with Black PE Jacket PE-1/2SFHC](#)

URL: <https://www.pasternack.com/50-ohm-low-loss-corrugated-1-2-superflexible-helical-coax-pe-1-2sfhc-p.aspx>

The information contained in this document is accurate to the best of our knowledge and representative of the part described herein. It may be necessary to make modifications to the part and/or the documentation of the part, in order to implement improvements. Pasternack reserves the right to make such changes as required. Unless otherwise stated, all specifications are nominal. Pasternack does not make any representation or warranty regarding the suitability of the part described herein for any particular purpose, and Pasternack does not assume any liability arising out of the use of any part or documentation.

# PE-1/2SFHC CAD Drawing

Low Loss 1/2 inch Superflexible Corrugated Coax Cable with Black PE Jacket

REVISIONS			
REV.	DESCRIPTION	DATE	APPROVED
1.1	PCR PE-1/2SFHC 20190708	07/16/19	S.ELLIS

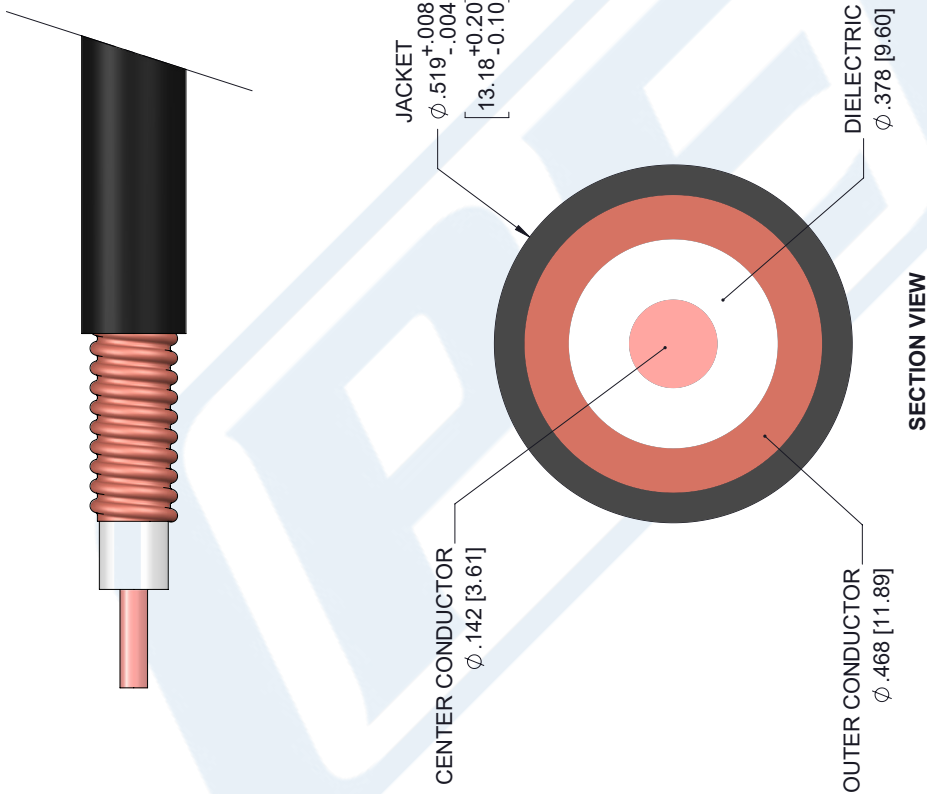

UNLESS OTHERWISE SPECIFIED LEADING DIMENSIONS ARE INCHES DIMENSIONS IN [ ] ARE MILLIMETERS	
TOLERANCES:	
X±.2 [5.08]	FRACTIONS ±.132
.XX±.01 [.25]	ANGLES ± 1°
.XXX±.005 [.13]	
ALL DIMENSIONS SHOWN ARE FOR REFERENCE ONLY.	
THIRD-ANGLE PROJECTION	

**(PE) PASTERNAK**  
an INFINITO brand

Pasternack Enterprises, Inc.  
P.O. Box 16759, Irvine, CA 92623.  
Phone: 1.949.261.1920 | 1.866.727.8376  
Fax: 1.949.261.7451  
www.pasternack.com | e-mail: sales@pasternack.com

SIZE [CAGE] DRAWN BY PART NUMBER REV  
A 53919 K.DANG PE-1/2SFHC 1.1

THE INFORMATION AND DESIGN IN THIS DOCUMENT IS THE PROPERTY OF PASTERNAK CORPORATION. ALL RIGHTS RESERVED.

SHEET 1 OF 1  
SCALE N/A

THESE COMMODITIES, TECHNOLOGY OR SOFTWARE WERE EXPORTED FROM THE UNITED STATES IN ACCORDANCE WITH THE EXPORT ADMINISTRATION REGULATIONS. DIVERSION CONTRARY TO U.S. LAW PROHIBITED.