



TNC Female Bulkhead Mount Connector Solder Attachment for PE-SR405AL, PE-SR405FL, PE-SR405FLJ, PE-SR405TN, RG405

RF Connectors Technical Data Sheet

PE44714

Configuration

- TNC Female Connector
- 50 Ohms
- Straight Body Geometry
- Connector Interface Types: PE-SR405AL, PE-SR-405FL, PE-SR405FLJ, PE-SR405TN, RG405
- Bulkhead

Features

- Max. Operating Frequency 6 GHz
- Gold over Nickel Plated Beryllium Copper Contact

Applications

- General Purpose Test
- Rack and Panel Mount Applications
- Custom Cable Assemblies

Description

Pasternack's PE44714 TNC female bulkhead connector with solder/solder attachment for PE-SR405AL, PE-SR405FL, PE-SR405FLJ, PE-SR405TN and RG405 is part of our full line of RF components available for same-day shipping. Our TNC female connector operates up to a maximum frequency of 6 GHz. This TNC bulkhead connector allows designers to create external connections on their product enclosures, and can be used in a variety of other rack mount and panel mount applications.

Our TNC female bulkhead connector PE44714 datasheet specifications and drawing with dimensions are shown below in this PDF. Pasternack's broad catalog of RF, microwave and millimeter wave connectors allows designers to configure and customize their signal connections however they like. Whether the need is to provide an I/O for a board design, or simply create a custom cable assembly configuration, Pasternack has the right connector for the job. Pasternack can also expertly build your custom cable assemblies for you and ship same-day.

Electrical Specifications

Description	Minimum	Typical	Maximum	Units
Frequency Range	DC		6	GHz

Mechanical Specifications

Size	
Length	0.992 in [25.2 mm]
Width/Dia.	0.69 in [17.53 mm]
Weight	0.038 lbs [17.24 g]

Click the following link (or enter part number in "SEARCH" on website) to obtain additional part information including price, inventory and certifications: [TNC Female Bulkhead Mount Connector Solder Attachment for PE-SR405AL, PE-SR405FL, PE-SR405FLJ, PE-SR405TN, RG405 PE44714](#)



TNC Female Bulkhead Mount Connector Solder Attachment for PE-SR405AL, PE-SR405FL, PE-SR405FLJ, PE-SR405TN, RG405

RF Connectors
Technical Data Sheet

PE44714

Material Specifications

Description	Material	Plating
Contact	Beryllium Copper	Gold over Nickel
Insulation	PTFE	
Body	Brass	Nickel

Environmental Specifications

Compliance Certifications (see [product page](#) for current document)

Plotted and Other Data

Notes:

TNC Female Bulkhead Mount Connector Solder Attachment for PE-SR405AL, PE-SR405FL, PE-SR405FLJ, PE-SR405TN, RG405 from Pasternack Enterprises has same day shipment for domestic and International orders. Our RF, microwave and millimeter wave products maintain a 99.4% availability and are part of the broadest selection in the industry.

Click the following link (or enter part number in "SEARCH" on website) to obtain additional part information including price, inventory and certifications: [TNC Female Bulkhead Mount Connector Solder Attachment for PE-SR405AL, PE-SR405FL, PE-SR405FLJ, PE-SR405TN, RG405 PE44714](#)

URL: <https://www.pasternack.com/tnc-female-standard-pe-sr405al-pe-sr405fl-pe-sr405flj-connector-pe44714-p.aspx>

The information contained in this document is accurate to the best of our knowledge and representative of the part described herein. It may be necessary to make modifications to the part and/or the documentation of the part, in order to implement improvements. Pasternack reserves the right to make such changes as required. Unless otherwise stated, all specifications are nominal. Pasternack does not make any representation or warranty regarding the suitability of the part described herein for any particular purpose, and Pasternack does not assume any liability arising out of the use of any part or documentation.

PE44714 CAD Drawing

TNC Female Bulkhead Mount Connector Solder Attachment for PE-SR405AL, PE-SR405FL, PE-SR405FLJ, PE-SR405TN, RG405

REVISIONS

REV.	DESCRIPTION	DATE	APPROVED
A	PCR PE44714 20200925	11/19/20	SRAUTUS

ASSEMBLY PROCEDURES

1. STRIP CABLE AS SHOWN. DO NOT NICK CENTER CONDUCTOR.

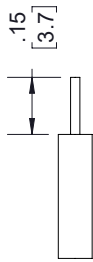

2. INSERT CLAMP NUT THROUGH CABLE. PLACE WASHER OVER CENTER CONDUCTOR. SOLDER CONTACT TO CENTER CONDUCTOR.

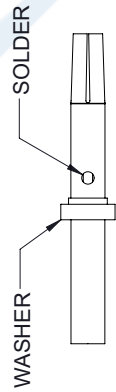

3. ASSEMBLE CONTACT, INSULATOR AND BODY TOGETHER. SCREW CLAMP NUT INTO THE BODY UNTIL IT BOTTOMS OUT.

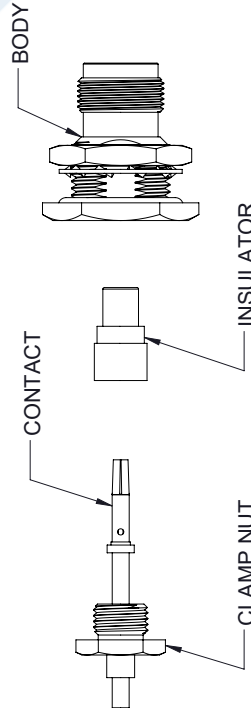

4. SOLDER OUTER CONDUCTOR TO CLAMP NUT AND TIGHTEN CLAMP NUT TO BODY.

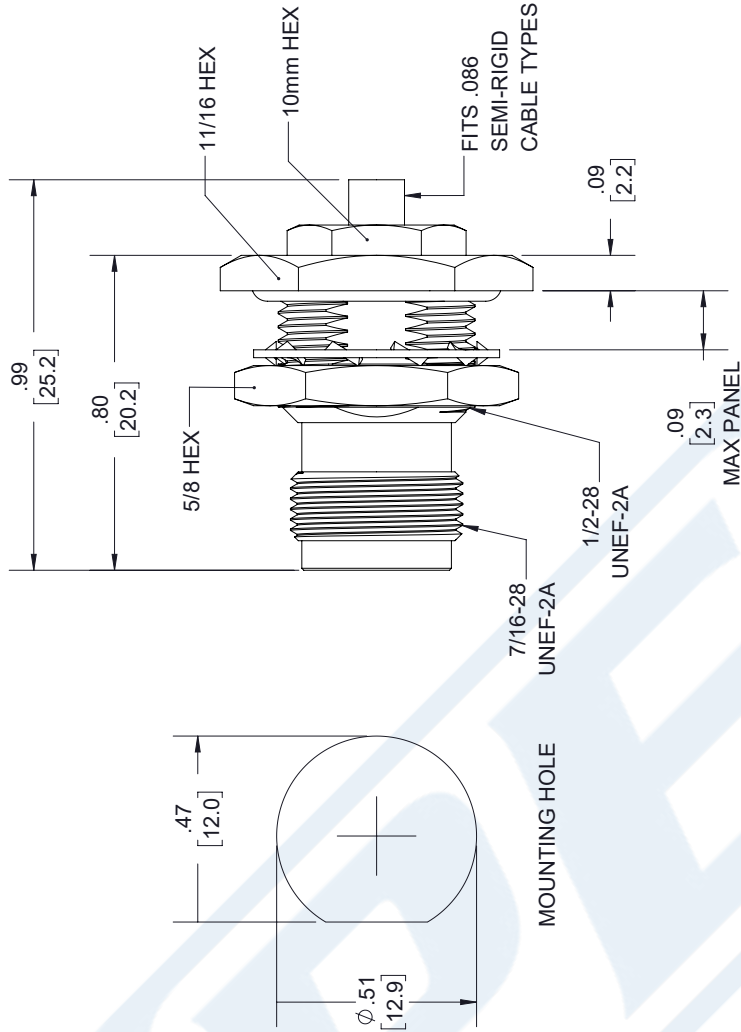
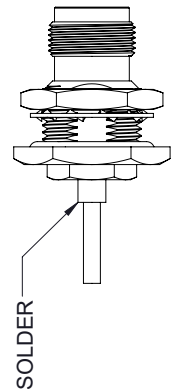

UNLESS OTHERWISE SPECIFIED LEADING DIMENSIONS ARE INCHES DIMENSIONS IN [] ARE MILLIMETERS

TOLERANCES:
 .X = ±.2 [5.08] FRACTIONS ± 1/32
 .XX = ±.02 [.51] ANGLES ± 1°
 .XXX = ±.005 [.13]
 CABLE LENGTH (L) TOLERANCES:
 L ≤ 12 [305] = +1 [25] / -0
 12 [305] < L ≤ 60 [1524] = +2 [51] / -0
 60 [1524] < L ≤ 120 [3048] = +4 [102] / -0
 120 [3048] < L ≤ 300 [7620] = +6 [152] / -0
 300 [7620] < L = +5%L / -0
 ALL DIMENSIONS SHOWN ARE FOR REFERENCE ONLY.



THE INFORMATION AND DESIGN INFORMATION IS THE PROPERTY OF PASTERNAK CORPORATION ALL RIGHTS RESERVED.

SHEET 1 OF 1

SCALE N/A



Pasternack Enterprises, Inc.
 P.O. Box 16759, Irvine, CA 92623.
 Phone: 1.949.261.1920 | 1.866.727.8376
 Fax: 1.949.261.7451
 Website: www.pasternack.com
 E-mail: sales@pasternack.com

ITEM NO. PE44714

SIZE A CAGE CODE 53919 DRAWN BY SLI

REV A



SMP Female Push-On Connector Solder Attachment for RG405, PE-SR405AL, PE-SR405FL, PE-SR405FLJ, Up To 8 GHz

RF Connectors Technical Data Sheet

PE45285

Configuration

- Push-On SMP Female Connector
- MIL-STD-348A
- 50 Ohms
- Straight Body Geometry
- RG405, PE-SR405AL, PE-SR405FL, PE-SR405FLJ Interface Type
- Solder/Solder Attachment

Features

- Max. Operating Frequency 8 GHz
- Excellent VSWR of 1.15:1
- Gold Plated Beryllium Copper Contact
- Contact plating according to MIL-DTL-45204
- Blind Mate Connector

Applications

- General Purpose Test
- Custom Cable Assemblies

Description

Pasternack's PE45285 SMP female push-on connector with solder/solder attachment for RG405, PE-SR405AL, PE-SR405FL and PE-SR405FLJ is part of our full line of RF components available for same-day shipping. Our SMP female connector operates up to a maximum frequency of 8 GHz and offers excellent VSWR of 1.15:1. The Pasternack blind mate connector is ideal for applications where direct visual or tactile access to the connection point is not possible, for example, when two circuit boards need to be mated.

Our SMP female connector PE45285 datasheet specifications and drawing with dimensions are shown below in this PDF. Pasternack's broad catalog of RF, microwave and millimeter wave connectors allows designers to configure and customize their signal connections however they like. Whether the need is to provide an I/O for a board design, or simply create a custom cable assembly configuration, Pasternack has the right connector for the job. Pasternack can also expertly build your custom cable assemblies for you and ship same-day. Pasternack 8 GHz SMP connectors are designed to offer a low cost alternative where the SMP form factor is desired but the standard SMP frequency range is not needed. The line of 8 GHz SMP connectors is fully compatible with industry standard SMP and GPO® connectors. These SMP connectors offer a low cost high performance blind-mate solution for lower frequency applications. The Male versions of the 8 GHz SMP is available in Full Detent, Limited Detent, and Smooth Bore versions.

Electrical Specifications

Description	Minimum	Typical	Maximum	Units
Frequency Range	DC		8	GHz
VSWR			1.15:1	

Mechanical Specifications

Size

- Length 0.25 in [6.35 mm]
- Width/Dia. 0.157 in [3.99 mm]

Click the following link (or enter part number in "SEARCH" on website) to obtain additional part information including price, inventory and certifications: [SMP Female Push-On Connector Solder Attachment for RG405, PE-SR405AL, PE-SR405FL, PE-SR405FLJ, Up To 8 GHz PE45285](#)



SMP Female Push-On Connector Solder Attachment for RG405,
PE-SR405AL, PE-SR405FL, PE-SR405FLJ, Up To 8 GHz

RF Connectors Technical Data Sheet

PE45285

Weight 0.0014 lbs [0.64 g]

Material Specifications

Description	Material	Plating
Contact	Beryllium Copper	Gold MIL-DTL-45204
Insulation	PTFE	
Outer Conductor	Beryllium Copper	Gold MIL-DTL-45204
Body	Beryllium Copper	Gold MIL-DTL-45204

Environmental Specifications

Temperature

Operating Range

-55 to +155 deg C

Humidity

MIL-STD-202, Method 106 (except 7b omitted)

Shock

MIL-STD-202, Method 213, Condition I

Vibration

MIL-STD-202, Method 204, Condition D

Salt Spray

MIL-STD-202, Method 101, Condition B

Click the following link (or enter part number in "SEARCH" on website) to obtain additional part information including price, inventory and certifications: [SMP Female Push-On Connector Solder Attachment for RG405, PE-SR405AL, PE-SR405FL, PE-SR405FLJ, Up To 8 GHz PE45285](#)



SMP Female Push-On Connector Solder Attachment for RG405,
PE-SR405AL, PE-SR405FL, PE-SR405FLJ, Up To 8 GHz

RF Connectors Technical Data Sheet

PE45285

Compliance Certifications (see [product page](#) for current document)

Plotted and Other Data

Notes:

SMP Female Push-On Connector Solder Attachment for RG405, PE-SR405AL, PE-SR405FL, PE-SR405FLJ, Up To 8 GHz from Pasternack Enterprises has same day shipment for domestic and International orders. Our RF, microwave and millimeter wave products maintain a 99% availability and are part of the broadest selection in the industry.

Click the following link (or enter part number in "SEARCH" on website) to obtain additional part information including price, inventory and certifications: [SMP Female Push-On Connector Solder Attachment for RG405, PE-SR405AL, PE-SR405FL, PE-SR405FLJ, Up To 8 GHz PE45285](#)

URL: <https://www.pasternack.com/smp-female-push-on-rg405-pe-sr405al-pe-sr405fl-pe-sr405flj-connector-pe45285-p.aspx>

The information contained in this document is accurate to the best of our knowledge and representative of the part described herein. It may be necessary to make modifications to the part and/or the documentation of the part, in order to implement improvements. Pasternack reserves the right to make such changes as required. Unless otherwise stated, all specifications are nominal. Pasternack does not make any representation or warranty regarding the suitability of the part described herein for any particular purpose, and Pasternack does not assume any liability arising out of the use of any part or documentation.

PE45285 CAD Drawing

SMP Female Push-On Connector Solder Attachment for RG405, PE-SR405AL, PE-SR405FL, PE-SR405FLJ, Up To 8 GHz

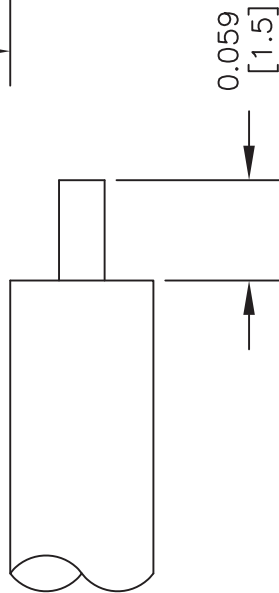
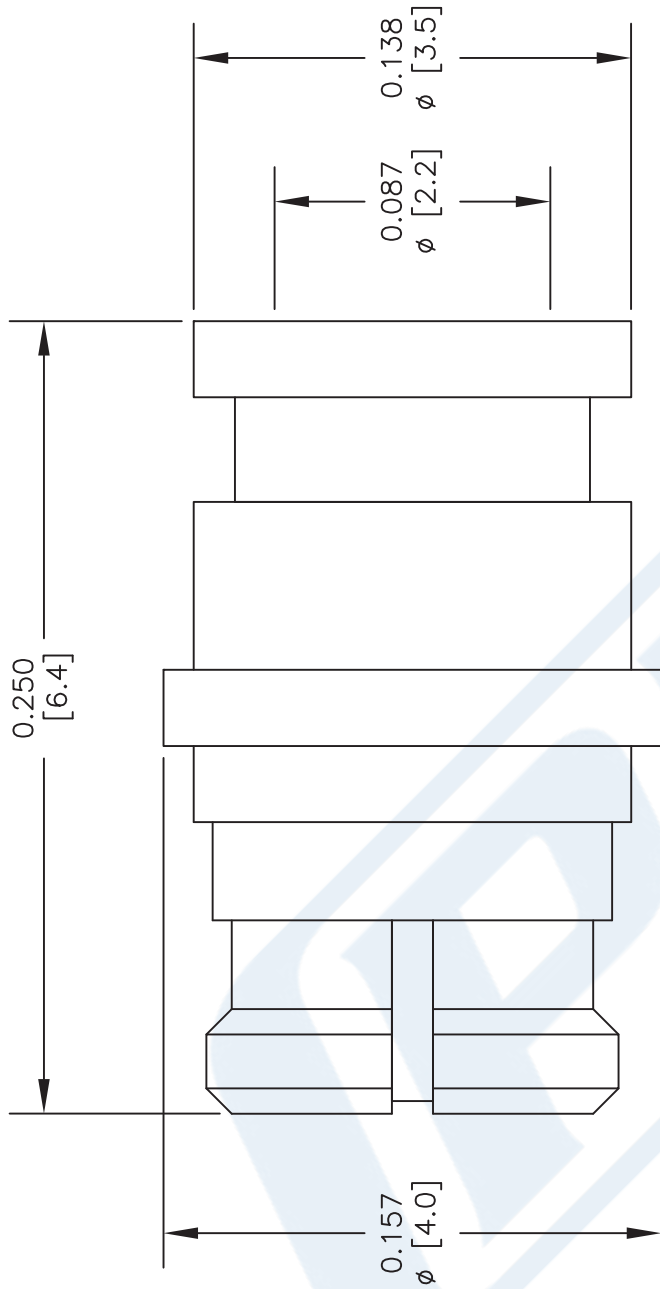

STRIPPING DIMENSIONS ASSEMBLY PROCEDURES

1. STRIP CABLE AS SHOWN. DO NOT NICK CENTER CONDUCTOR.
2. SOLDER CONTACT TO CENTER CONDUCTOR.
3. INSERT CABLE INTO BODY UNTIL IT BOTTOMS OUT. SOLDER OUTER CONDUCTOR TO BODY.

DWG TITLE

PE45285

- NOTES:
1. UNLESS OTHERWISE SPECIFIED ALL DIMENSIONS ARE NOMINAL.
 2. ALL SPECIFICATIONS ARE SUBJECT TO CHANGE WITHOUT NOTICE AT ANY TIME.
 3. DIMENSIONS ARE IN INCHES [mm].
 4. FITS MIL-C-17 AND EQUIVALENT CABLES.

PE PASTERNAK
THE ENGINEERS' RF SOURCE
Pasternack Enterprises, Inc.
P.O. Box 16759 | Irvine | CA | 92623
Phone: (949) 261-1920 | Fax: (949) 261-7451
Website: www.pasternack.com | E-Mail: sales@pasternack.com

FSCM NO. 53919

CAD FILE 081616

SCALE N/A

SIZE A

2233



Formable 086 Semirigid Coax Cable with Tinned Braid Outer Conductor and Black FEP Jacket

RF Cables Technical Data Sheet

PE-SR405FLJ

Configuration

- Formable Cable
- 1 Shield(s)

Features

- Dimensionally the same as standard solid outer conductor semi-rigid coax
- Standard semi-rigid connectors can be used
- Cable is hand formable and does not require special tools to bend
- Connectors are easily soldered to Tin soaked outer conductor
- Cable can be formed more than once without damage to outer conductor
- High RF Shielding >100 dB

Description

Formable semi-rigid coax is a hand formable version of standard semi-rigid that does not require complicated and costly pre-formed cable assemblies. Because the dimensions and electrical characteristics are so closely matched to semi-rigid coax, standard semi-rigid connectors can be used. The tin soaked copper braid outer shield provides excellent RF shielding. FEP Jacket reduces the chance of shorting exposed contacts or circuit conductors.

Electrical Specifications

Description	Minimum	Typical	Maximum	Units
Frequency Range	DC		61	GHz
Impedance		50		Ohms
Velocity of Propagation		69.5		%
Time Delay		1.43 [4.69]		ns/ft [ns/m]
Shielding Effectiveness	100			dB
Operating Voltage (AC)			1,500	Vrms
Inner Conductor DC Resistance			65.7	Ohms/1000ft
Outer Conductor DC Resistance			10.2	Ohms/1000ft
Nominal Capacitance		29 [95.14]		pF/ft [pF/m]

Performance by Frequency Band

Description	F1	F2	F3	F4	F5	Units
Frequency	0.5	1	5	10	20	GHz
Attenuation, Typ	15	22.5	54.9	81.2	120	dB/100ft
	49.21	73.82	180.12	266.4	393.7	dB/100m
Input Power (CW), Max	173.5	121.5	52.2	35.8	24.3	Watts

Click the following link (or enter part number in "SEARCH" on website) to obtain additional part information including price, inventory and certifications: [Formable PE-SR405FLJ Coax Cable with Outer Conductor and Black FEP Jacket PE-SR-405FLJ](#)



Formable 086 Semirigid Coax Cable with Tinned Braid Outer Conductor and Black FEP Jacket

RF Cables Technical Data Sheet

PE-SR405FLJ

Mechanical Specifications

Diameter	0.105 in [2.67 mm]
Weight	0.015 lbs/ft [0.02 Kg/m]
Min. Bend Radius (Installation)	0.5 in [12.7 mm]
Min. Bend Radius (Repeated)	0.787 in [19.99 mm]

Construction Specifications

Description	Material and Plating	Diameter
Inner Conductor	Copper Clad Steel, Silver, 1 Strands	0.02 in [0.51 mm]
Conductor Type	Solid	
Dielectric	PTFE	0.062 in [1.57 mm]
Outer Conductor	Tinned Copper Composite Braid	0.085 in [2.16 mm]
Jacket	FEP, Black	0.105 in [2.67 mm]

Environmental Specifications

Temperature

Operating Range	-55 to +125 deg C
-----------------	-------------------

Compliance Certifications (see [product page](#) for current document)

Plotted and Other Data

Notes:

Formable 086 Semirigid Coax Cable with Tinned Braid Outer Conductor and Black FEP Jacket from Pasternack Enterprises has same day shipment for domestic and International orders. Our RF, microwave and millimeter wave products maintain a 99.4% availability and are part of the broadest selection in the industry.

Click the following link (or enter part number in "SEARCH" on website) to obtain additional part information including price, inventory and certifications: [Formable PE-SR405FLJ Coax Cable with Outer Conductor and Black FEP Jacket PE-SR405FLJ](#)

URL: <https://www.pasternack.com/50-ohm-formable-086-semirigid-tinned-braid-outer-conductor-fep-jacket-black-pe-sr405flj-p.aspx>

The information contained in this document is accurate to the best of our knowledge and representative of the part described herein. It may be necessary to make modifications to the part and/or the documentation of the part, in order to implement improvements. Pasternack reserves the right to make such changes as required. Unless otherwise stated, all specifications are nominal. Pasternack does not make any representation or warranty regarding the suitability of the part described herein for any particular purpose, and Pasternack does not assume any liability arising out of the use of any part or documentation.

PE-SR405FLJ CAD Drawing

Formable 086 Semirigid Coax Cable with Tinned Braid
Outer Conductor and Black FEP Jacket



NOTES:
1. UNLESS OTHERWISE SPECIFIED ALL DIMENSIONS ARE NOMINAL.
2. ALL SPECIFICATIONS ARE SUBJECT TO CHANGE WITHOUT NOTICE AT ANY TIME.
3. DIMENSIONS ARE IN INCHES [mm].

DWG TITLE
PE-SR405FLJ

CAGE CODE 53919

CAD FILE 062817

SCALE N/A

SIZE A

2233



Pasternack Enterprises, Inc.
P.O. Box 16759 | Irvine | CA | 92623
Phone: (949) 261-1920 | Fax: (949) 261-7451
Website: www.pasternack.com | E-Mail: sales@pasternack.com