



BNC Male Connector Crimp/Solder Attachment for RG213, RG215, RG8

RF Connectors Technical Data Sheet

PE4378

Configuration

- BNC Male Connector
- MIL-STD-348A
- 50 Ohms
- Straight Body Geometry
- RG213, RG215, RG8 Interface Type
- Crimp/Solder Attachment

Features

- Max. Operating Frequency 4 GHz
- Good VSWR of 1.5:1
- Gold Plated Brass Contact
- 30 µin minimum contact plating

Applications

- General Purpose Test
- Custom Cable Assemblies

Description

Pasternack's PE4378 BNC male connector with crimp/solder attachment for RG213, RG215 and RG8 is part of our full line of RF components available for same-day shipping. Our BNC male connector operates up to a maximum frequency of 4 GHz and offers good VSWR of 1.5:1.

Our BNC male connector PE4378 datasheet specifications and drawing with dimensions are shown below in this PDF. Pasternack's broad catalog of RF, microwave and millimeter wave connectors allows designers to configure and customize their signal connections however they like. Whether the need is to provide an I/O for a board design, or simply create a custom cable assembly configuration, Pasternack has the right connector for the job. Pasternack can also expertly build your custom cable assemblies for you and ship same-day.

Electrical Specifications

| Description | Minimum | Typical | Maximum | Units |
|------------------------|---------|---------|---------|-------|
| Frequency Range | DC | | 4 | GHz |
| VSWR | | | 1.5:1 | |
| Operating Voltage (AC) | | | 500 | Vrms |

Mechanical Specifications

Size

| | |
|------------|---------------------|
| Length | 1.37 in [34.8 mm] |
| Width/Dia. | 0.57 in [14.48 mm] |
| Weight | 0.036 lbs [16.33 g] |

Click the following link (or enter part number in "SEARCH" on website) to obtain additional part information including price, inventory and certifications: [BNC Male Connector Crimp/Solder Attachment for RG213, RG215, RG8 PE4378](#)



BNC Male Connector Crimp/Solder Attachment for RG213, RG215, RG8

RF Connectors Technical Data Sheet

PE4378

Material Specifications

| Description | Material | Plating |
|--------------|----------|---------------------------|
| Contact | Brass | Gold 30 µin minimum |
| Insulation | PTFE | |
| Body | Brass | Nickel 100 µin minimum |
| Coupling Nut | Brass | Nickel 100 µin minimum |

Environmental Specifications

Temperature

Operating Range

-65 to +165 deg C

Compliance Certifications (see [product page](#) for current document)

Plotted and Other Data

Notes:

BNC Male Connector Crimp/Solder Attachment for RG213, RG215, RG8 from Pasternack Enterprises has same day shipment for domestic and International orders. Our RF, microwave and millimeter wave products maintain a 99% availability and are part of the broadest selection in the industry.

Click the following link (or enter part number in "SEARCH" on website) to obtain additional part information including price, inventory and certifications: [BNC Male Connector Crimp/Solder Attachment for RG213, RG215, RG8 PE4378](#)

URL: <https://www.pasternack.com/bnc-male-rg213-rg8-connector-pe4378-p.aspx>

The information contained in this document is accurate to the best of our knowledge and representative of the part described herein. It may be necessary to make modifications to the part and/or the documentation of the part, in order to implement improvements. Pasternack reserves the right to make such changes as required. Unless otherwise stated, all specifications are nominal. Pasternack does not make any representation or warranty regarding the suitability of the part described herein for any particular purpose, and Pasternack does not assume any liability arising out of the use of any part or documentation.

PE4378 CAD Drawing

BNC Male Connector Crimp/Solder Attachment for RG213, RG215, RG8

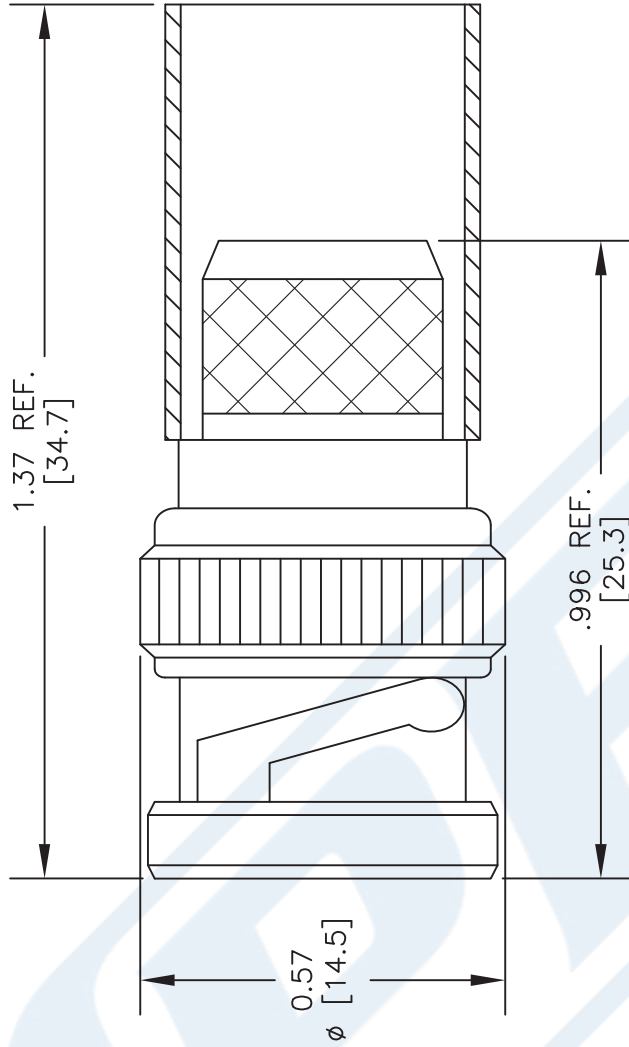

STRIPPING DIMENSIONS

CRIMP SIZE REQUIRED

CONTACT: SOLDER
 FERRULE: .429" HEX CRIMP TOOL

DWG TITLE

PE4378

NOTES:
 1. UNLESS OTHERWISE SPECIFIED ALL DIMENSIONS ARE NOMINAL.
 2. ALL SPECIFICATIONS ARE SUBJECT TO CHANGE WITHOUT NOTICE AT ANY TIME.
 3. DIMENSIONS ARE IN INCHES [mm].
 4. FITS MIL-C-17 AND EQUIVALENT CABLES.

FSCM NO. 53919

2233

SIZE A

SCALE N/A

CAD FILE 110612-B



PASTERNAK®
 Pasternack Enterprises, Inc.
 P.O. Box 16759 | Irvine | CA | 92623
 Phone: (949) 261-1920 | Fax: (949) 261-7451
 Website: www.pasternack.com | E-Mail: sales@pasternack.com



N Female Connector Clamp/Solder (Captive Contact)
Attachment for RG213, RG214, RG8, RG9, RG11,
RG225, RG393, RG144, RG216, RG215

RF Connectors
Technical Data Sheet

PE4059

Configuration

- N Female Connector
- MIL-STD-348
- 50 Ohms
- Straight Body Geometry
- RG213, RG214, RG8, RG9, RG11, RG225, RG393, RG144, RG216, RG215 Interface Type
- Clamp/Solder (Captive Contact) Attachment

Features

- Silver Plated Contact
- Contact plating according to QQ-S-365

Applications

- General Purpose Test
- Custom Cable Assemblies

Description

Pasternack's PE4059 type N female connector with clamp/solder (captive contact) attachment for RG213, RG214, RG8, RG9, RG11, RG225, RG393, RG144, RG216 and RG215 is part of our full line of RF components available for same-day shipping.

Our type N female connector PE4059 datasheet specifications and drawing with dimensions are shown below in this PDF. Pasternack's broad catalog of RF, microwave and millimeter wave connectors allows designers to configure and customize their signal connections however they like. Whether the need is to provide an I/O for a board design, or simply create a custom cable assembly configuration, Pasternack has the right connector for the job. Pasternack can also expertly build your custom cable assemblies for you and ship same-day.

Mechanical Specifications

| | |
|-------------|---------------------|
| Size | |
| Length | 1.56 in [39.62 mm] |
| Width/Dia. | 0.75 in [19.05 mm] |
| Weight | 0.108 lbs [48.99 g] |

Material Specifications

| Description | Material | Plating |
|-------------|----------|--------------------|
| Contact | | Silver QQ-S-365 |
| Insulation | PTFE | |
| Body | Brass | Nickel QQ-N-290 |

Click the following link (or enter part number in "SEARCH" on website) to obtain additional part information including price, inventory and certifications: [N Female Connector Clamp/Solder \(Captive Contact\) Attachment for RG213, RG214, RG8, RG9, RG11, RG225, RG393, RG144, RG216, RG215 PE4059](#)



N Female Connector Clamp/Solder (Captive Contact)
Attachment for RG213, RG214, RG8, RG9, RG11,
RG225, RG393, RG144, RG216, RG215

RF Connectors
Technical Data Sheet

PE4059

Environmental Specifications

Compliance Certifications (see [product page](#) for current document)

Plotted and Other Data

Notes:

Click the following link (or enter part number in "SEARCH" on website) to obtain additional part information including price, inventory and certifications: [N Female Connector Clamp/Solder \(Captive Contact\) Attachment for RG213, RG214, RG8, RG9, RG11, RG225, RG393, RG144, RG216, RG215 PE4059](#)



N Female Connector Clamp/Solder (Captive Contact)
Attachment for RG213, RG214, RG8, RG9, RG11,
RG225, RG393, RG144, RG216, RG215

RF Connectors
Technical Data Sheet

PE4059

Assembly Instruction

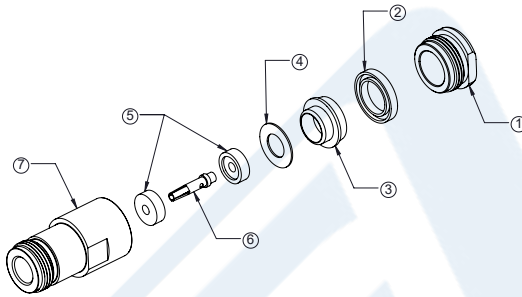

1. SLIDE CLAMP NUT (1) AND GASKET (2) OVER CABLE. STRIP CABLE AS SHOWN. DO NOT NICK BRAID WHILE CUTTING JACKET. TAPER END OF BRAID TO PERMIT ASSEMBLY OF CLAMP.

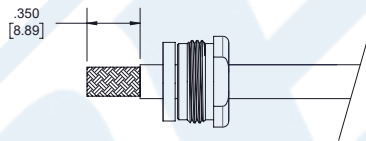

2. SLIDE BRAID CLAMP (3) OVER BRAID & SEAT AGAINST CABLE. FORM BRAID OVER BRAID CLAMP (3). TRIM BRAID BACK TO SHOULDER. CUT DIELECTRIC & CENTER CONDUCTOR TO DIMENSIONS SHOWN. DO NOT NICK CENTER CONDUCTOR.

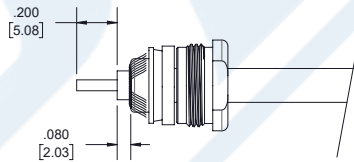

3. SLIDE WASHER (4) AGAINST THE BRAID CLAMP (3) AND HOLD BRAID IN PLACE. SLIDE HALF-INSULATOR (5) BEFORE SOLDER CONTACT (6) TO CENTER CONDUCTOR. SOLDER & REMOVE EXCESS SOLDER. DO NOT OVER HEAT DIELECTRIC. SLIDE A REST HAFT-INSULATOR (5) TO LOCKED CONTACT. INSERT CABLE ASSEMBLY INTO BODY (7) & TIGHTEN.

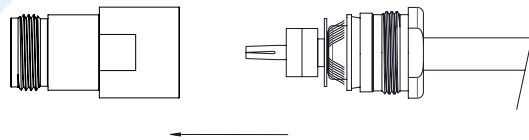
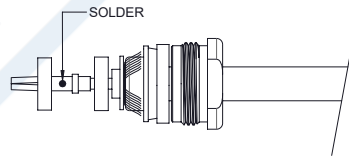

Click the following link (or enter part number in "SEARCH" on website) to obtain additional part information including price, inventory and certifications: [N Female Connector Clamp/Solder \(Captive Contact\) Attachment for RG213, RG214, RG8, RG9, RG11, RG225, RG393, RG144, RG216, RG215 PE4059](#)



N Female Connector Clamp/Solder (Captive Contact)
Attachment for RG213, RG214, RG8, RG9, RG11,
RG225, RG393, RG144, RG216, RG215

RF Connectors
Technical Data Sheet

PE4059

N Female Connector Clamp/Solder (Captive Contact) Attachment for RG213, RG214, RG8, RG9, RG11, RG225, RG393, RG144, RG216, RG215 from Pasternack Enterprises has same day shipment for domestic and International orders. Our RF, microwave and millimeter wave products maintain a 99.4% availability and are part of the broadest selection in the industry.

Click the following link (or enter part number in "SEARCH" on website) to obtain additional part information including price, inventory and certifications: [N Female Connector Clamp/Solder \(Captive Contact\) Attachment for RG213, RG214, RG8, RG9, RG11, RG225, RG393, RG144, RG216, RG215 PE4059](https://www.pasternack.com/n-female-standard-rg213-rg214-rg8-rg9-rg11-rg225-rg393-connector-pe4059-p.aspx)

URL: <https://www.pasternack.com/n-female-standard-rg213-rg214-rg8-rg9-rg11-rg225-rg393-connector-pe4059-p.aspx>

The information contained in this document is accurate to the best of our knowledge and representative of the part described herein. It may be necessary to make modifications to the part and/or the documentation of the part, in order to implement improvements. Pasternack reserves the right to make such changes as required. Unless otherwise stated, all specifications are nominal. Pasternack does not make any representation or warranty regarding the suitability of the part described herein for any particular purpose, and Pasternack does not assume any liability arising out of the use of any part or documentation.

PE4059 CAD Drawing

N Female Connector Clamp/Solder (Captive Contact) Attachment for RG213, RG214, RG8, RG9, RG11, RG225, RG393, RG144, RG216, RG215

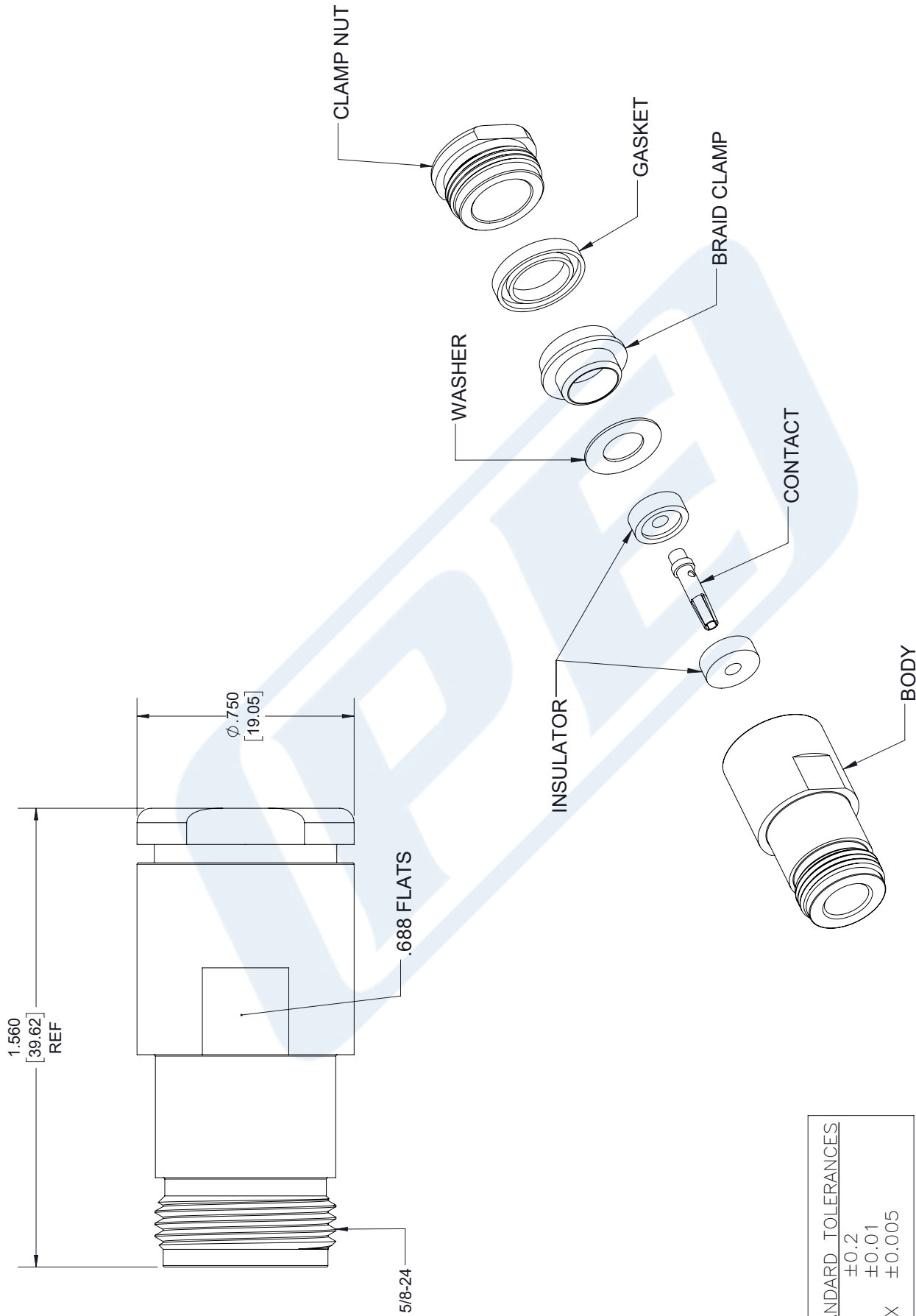

| STANDARD TOLERANCES | |
|---------------------|--------|
| .X | ±0.2 |
| .XX | ±0.01 |
| .XXX | ±0.005 |

*STANDARD TOLERANCES APPLY ONLY TO DIMENSIONS IN INCHES



Pasternack Enterprises, Inc.
 P.O. Box 16759 | Irvine | CA | 92623
 Phone: (949) 261-1920 | Fax: (949) 261-7451
 Website: www.pasternack.com | E-Mail: sales@pasternack.com

DWG TITLE

PE4059

NOTES:
 1. UNLESS OTHERWISE SPECIFIED ALL DIMENSIONS ARE NOMINAL.
 2. ALL SPECIFICATIONS ARE SUBJECT TO CHANGE WITHOUT NOTICE AT ANY TIME.
 3. DIMENSIONS ARE IN INCHES [mm].

CAGE CODE 53919

CAD FILE 05/01/18

SCALE N/A

SIZE A

7361



Flexible RG8 Coax Cable Single Shielded with Black PVC (NC) Jacket

RF Cables Technical Data Sheet

RG8A/U

Times Microwave Systems Coax Cable Specification Configuration

- Flexible Cable
- 1 Shield(s)

Electrical Specifications

| Description | Minimum | Typical | Maximum | Units |
|-------------------------|---------|---------------|---------|--------------|
| Frequency Range | DC | | 1,000 | MHz |
| Impedance | | 50 | | Ohms |
| Velocity of Propagation | | 66 | | % |
| Nominal Capacitance | | 30.8 [101.05] | | pF/ft [pF/m] |

Performance by Frequency Band

| Description | F1 | F2 | F3 | F4 | F5 | Units |
|------------------|------|------|------|-------|-------|----------|
| Frequency | 1 | 10 | 50 | 400 | 700 | MHz |
| Attenuation, Typ | 0.2 | 0.6 | 1.3 | 4.1 | 6.5 | dB/100ft |
| | 0.66 | 1.97 | 4.27 | 13.45 | 21.33 | dB/100m |

| Description | F6 | F7 | F8 | F9 | F10 | Units |
|------------------|-------|-------|----|----|-----|----------|
| Frequency | 900 | 1,000 | | | | MHz |
| Attenuation, Typ | 7.6 | 8 | | | | dB/100ft |
| | 24.93 | 26.25 | | | | dB/100m |

Mechanical Specifications

| | |
|----------|--------------------------|
| Diameter | 0.405 in [10.29 mm] |
| Weight | 0.105 lbs/ft [0.16 Kg/m] |

Construction Specifications

| Description | Material and Plating | Diameter |
|-----------------|----------------------|--------------------|
| Inner Conductor | Copper, 7 Strands | 0.085 in [2.16 mm] |

Click the following link (or enter part number in "SEARCH" on website) to obtain additional part information including price, inventory and certifications: [Flexible RG8 Coax Cable Single Shielded with Black PVC \(NC\) Jacket RG8A/U](#)



Flexible RG8 Coax Cable Single Shielded with Black PVC (NC) Jacket

RF Cables Technical Data Sheet

RG8A/U

| | | |
|----------------|-----------------|---------------------|
| Conductor Type | Stranded | |
| Dielectric | PE | 0.285 in [7.24 mm] |
| First Shield | Copper Braid | 0.318 in [8.08 mm] |
| Jacket | PVC (NC), Black | 0.405 in [10.29 mm] |

Environmental Specifications

Temperature

Operating Range -40 to +80 deg C

Compliance Certifications (see [product page](#) for current document)

Plotted and Other Data

Notes:

Flexible RG8 Coax Cable Single Shielded with Black PVC (NC) Jacket from Pasternack Enterprises has same day shipment for domestic and International orders. Our RF, microwave and millimeter wave products maintain a 99.4% availability and are part of the broadest selection in the industry.

Click the following link (or enter part number in "SEARCH" on website) to obtain additional part information including price, inventory and certifications: [Flexible RG8 Coax Cable Single Shielded with Black PVC \(NC\) Jacket RG8A/U](#)

URL: <https://www.pasternack.com/flexible-0.405-rg8-52-ohm-coax-cable-pvc-jacket-rg8a-u-p.aspx>

The information contained in this document is accurate to the best of our knowledge and representative of the part described herein. It may be necessary to make modifications to the part and/or the documentation of the part, in order to implement improvements. Pasternack reserves the right to make such changes as required. Unless otherwise stated, all specifications are nominal. Pasternack does not make any representation or warranty regarding the suitability of the part described herein for any particular purpose, and Pasternack does not assume any liability arising out of the use of any part or documentation.

RG8A/U CAD Drawing

Flexible RG8 Coax Cable Single Shielded with Black PVC (NC) Jacket

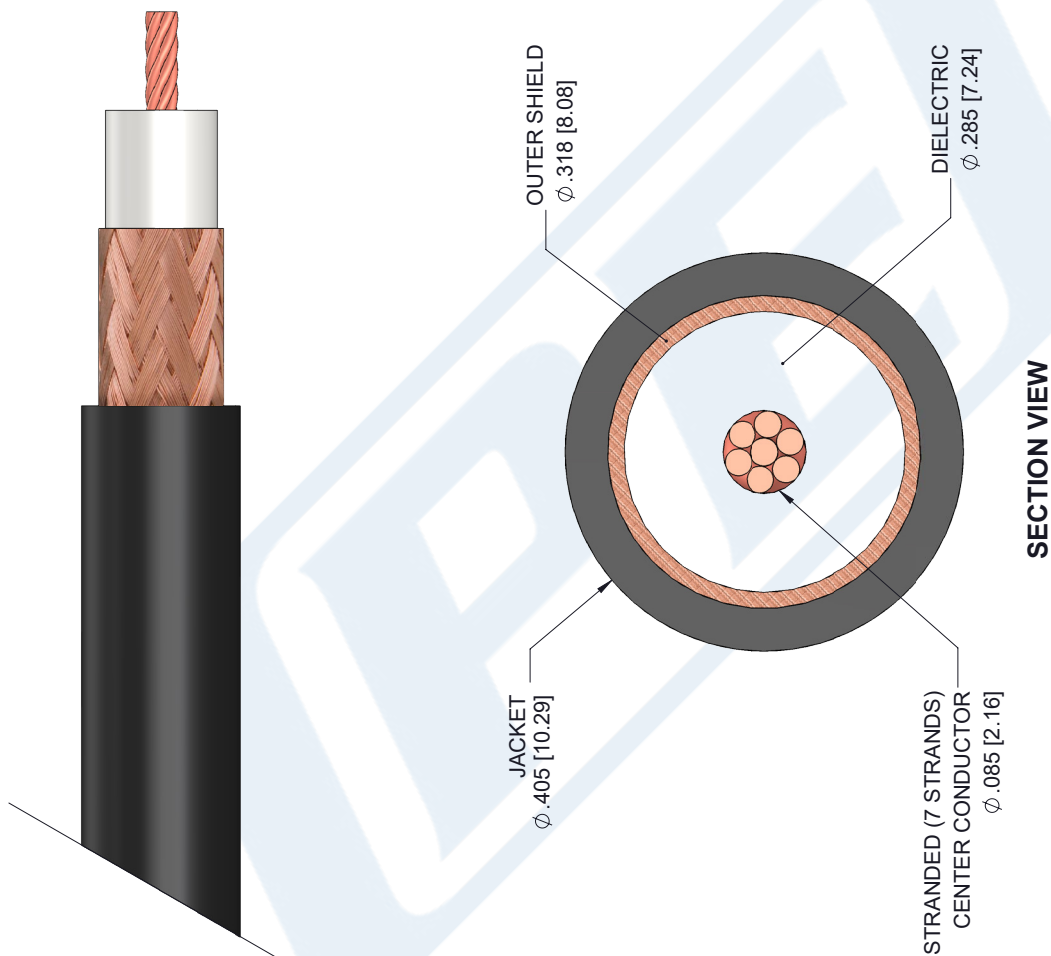

| STANDARD TOLERANCES | |
|---------------------|--------|
| .X | ±0.2 |
| .XX | ±0.01 |
| .XXX | ±0.005 |

*STANDARD TOLERANCES APPLY ONLY TO DIMENSIONS IN INCHES



Pasternack Enterprises, Inc.
 P.O. Box 16759 | Irvine | CA | 92623
Phone: (949) 261-1920 | **Fax:** (949) 261-7451
Website: www.pasternack.com | **E-Mail:** sales@pasternack.com

DWG TITLE

RG8A/U

NOTES:
 1. UNLESS OTHERWISE SPECIFIED ALL DIMENSIONS ARE NOMINAL.
 2. ALL SPECIFICATIONS ARE SUBJECT TO CHANGE WITHOUT NOTICE AT ANY TIME.
 3. DIMENSIONS ARE IN INCHES [mm].

CAGE CODE 53919

CAD FILE 12/21/18

SCALE N/A

SIZE A

7361