

NOTICE OF PROPRIETARY RIGHTS THIS DOCUMENT CONTAINS CONFIDENTIAL TECHNICAL DATA, INCLUDING TRADE SECRETS, PROPRIETARY TO TIMES MICROWAVE SYSTEMS. DISCLOSURE OF THIS DATA IS EXPRESSLY CONDITIONED UPON YOUR ASSENT THAT ITS USE IS LIMITED TO USE WITHIN YOUR COMPANY ONLY. ANY OTHER USE IS STRICTLY PROHIBITED WITHOUT THE PRIOR WRITTEN CONSENT OF TIMES MICROWAVE SYSTEMS.

SYM	REVISION DESCRIPTION	DFTM	DATE	APPD	DATE
A	RELEASED FOR PRODUCTION	K.A.M.	5/20/11	J.D.B.	6/9/11

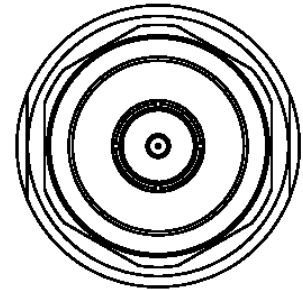
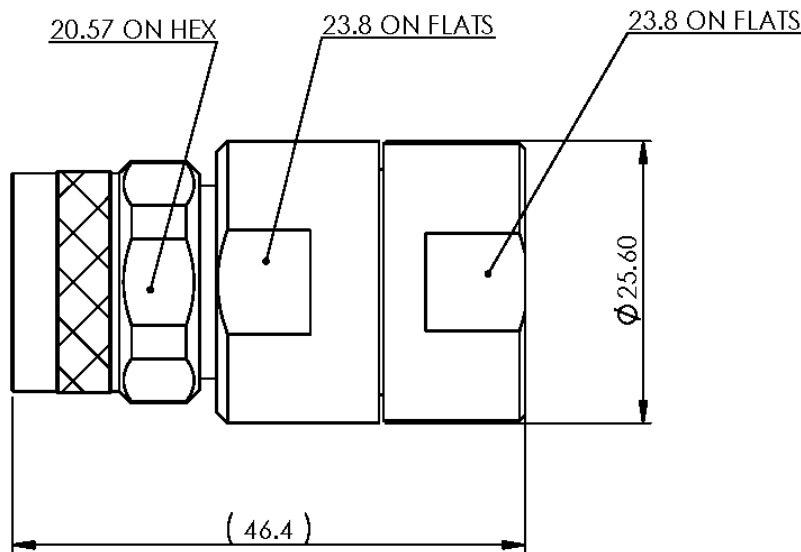
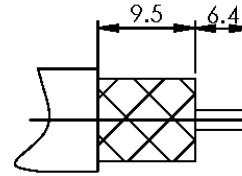

Reference standard IEC60169-16

I. Electric Performance

Nominal Impedance(Ω): 50
 Frequency Range: DC-6GHz
 VSWR: ≤ 1.35
 Insert Loss: ≤ 0.10 (0-3G)
 Insulation resistance ($M\Omega$): > 5000
 Proof voltage (V): 2500
 Conductor resistance ($m\Omega$):
 outer conductor < 0.4
 inner conductor < 0.8

II. Mechanical Performance

Whorl pull: 500N
 Nut torque: 5N.m
 Tensile force(cable-connect): 300N
 Torsion(cable-connect): 3N.m

II. Material and plating :

Component	Material	Plating
inner conductor	Beryllium copper	Au $>1.27\mu m$
outer conductor	Brass	Copper-tin-zinc $>2\mu m$
insulator	PTFE	
nut	Brass	Copper-tin-zinc $>2\mu m$

III. Environment

Temp.range	-55°C~+155°C
Thermal shock	US MIL-STD 202,Meth.107,Cond.B
Vibration	US MIL-STD 202,Meth.204,Cond.B
Shock	US MIL-STD 202,Meth.213,Cond.I
Weather standard	IEC 68 55 /155/ 56
ROHS compliant	

V. Assemble: inner and outer conductor installed

MATL:	UNLESS OTHERWISE SPECIFIED		DFTM: K. A. M.	TIMES MICROWAVE SYSTEMS			
	ALL DIMENSIONS ARE IN mm		DATE: 5/20/11				
USED ON:			CHKD: J. D. B.	CONNECTOR, NM FOR LMR-600 (EZ-600-NMC-2-D)			
			DATE: 6/9/11				
SCALE: ~	DWG. SIZE: A	DO NOT SCALE DRAWING	CODE IDENT: 68999	DATE: 6/9/11	SHEET: 1 of 1	SD3190-2641	REV: A

NOTICE OF PROPRIETARY RIGHTS THIS DOCUMENT CONTAINS CONFIDENTIAL TECHNICAL DATA, INCLUDING TRADE SECRETS, PROPRIETARY TO TIMES MICROWAVE SYSTEMS. DISCLOSURE OF THIS DATA IS EXPRESSLY CONDITIONED UPON YOUR ASSENT THAT ITS USE IS LIMITED TO USE WITHIN YOUR COMPANY ONLY. ANY OTHER USE IS STRICTLY PROHIBITED WITHOUT THE PRIOR WRITTEN CONSENT OF TIMES MICROWAVE SYSTEMS.

SYM	REVISION DESCRIPTION	DFTM	DATE	APPD	DATE
A	RELEASED FOR PRODUCTION	K.A.M.	5/20/11	J.D.B.	6/9/11

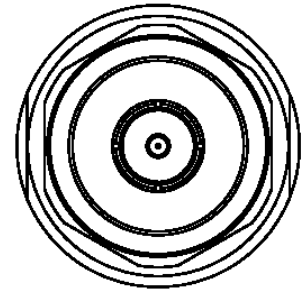
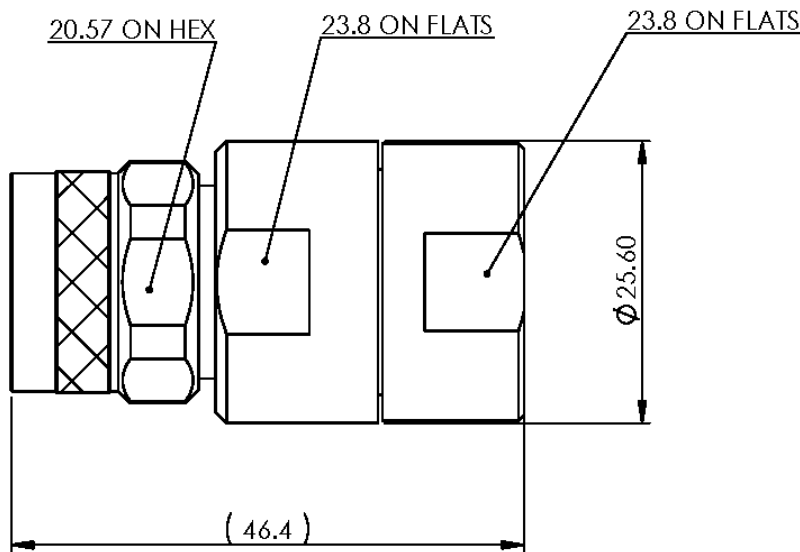
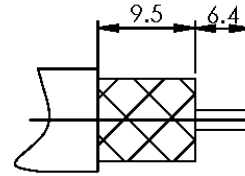

Reference standard IEC60169-16

I. Electric Performance

Nominal Impedance(Ω): 50
 Frequency Range: DC-6GHz
 VSWR: ≤ 1.35
 Insert Loss: ≤ 0.10 (0-3G)
 Insulation resistance ($M\Omega$): > 5000
 Proof voltage (V): 2500
 Conductor resistance ($m\Omega$):
 outer conductor < 0.4
 inner conductor < 0.8

II. Mechanical Performance

Whorl pull: 500N
 Nut torque: 5N.m
 Tensile force(cable-connect): 300N
 Torsion(cable-connect): 3N.m

II. Material and plating :

Component	Material	Plating
inner conductor	Beryllium copper	Au $>1.27\mu m$
outer conductor	Brass	Copper-tin-zinc $>2\mu m$
insulator	PTFE	
nut	Brass	Copper-tin-zinc $>2\mu m$

III. Environment

Temp.range	-55°C~+155°C
Thermal shock	US MIL-STD 202,Meth.107,Cond.B
Vibration	US MIL-STD 202,Meth.204,Cond.B
Shock	US MIL-STD 202,Meth.213,Cond.I
Weather standard	IEC 68 55 /155/ 56
ROHS compliant	

V. Assemble: inner and outer conductor installed

MATL:	UNLESS OTHERWISE SPECIFIED		DFTM: K. A. M.	TIMES MICROWAVE SYSTEMS			
	ALL DIMENSIONS ARE IN mm		DATE: 5/20/11				
USED ON:			CHKD: J. D. B.	CONNECTOR, NM FOR LMR-600 (EZ-600-NMC-2-D)			
			DATE: 6/9/11				
SCALE: ~	DWG. SIZE: A	DO NOT SCALE DRAWING	CODE IDENT: 68999	DATE: 6/9/11	1 of 1	SD3190-2641	REV: A



LMR-LW600 Light weight version of the 600 series Low Loss Coax

Times Microwave Systems Coax Cable Specification

Configuration

- Low Loss, Outdoor Flexible Cable
- 2 Shield(s)

Features

- Light Weight Coax with Aluminum Shielding
- Max Operating Frequency of 8 GHz
- Phase Velocity 85% VoP
- Max Operating Temperature +85°C
- PE Jacket
- Min Install Bend Radius of 1.5 inches

Applications

- Antenna Installs
- RF Test Systems
- General Purpose RF Interconnect
- Laboratory Applications

Description

LMR-LW600 Light weight version of the 600 series Low Loss Coax from Times Microwave is part of the large product offering by Pasternack of radio frequency coaxial cable types specifically stocked to be ready for same-day shipment. Pasternack LMR-LW600 coax cable is manufactured in a flexible design and has a 50 Ohm impedance. This low loss and light weight flexible 50 Ohm coax cable LMR-LW600 is constructed with a 0.590 inch diameter and Black PE jacket.

LMR-LW600 flexible 50 Ohm coax cable with PE jacket is rated for a 8 GHz maximum operating frequency. This 50 Ohm 0.590 inch diameter and low loss flexible coax cable is built with an aluminum double shield count and RF shielding of 90 dB. Times Microwave LMR-LW600 PE coax is constructed with Foam PE dielectric and a maximum operating temperature of 85 degrees C. Pasternack's offering of LMR-LW600 coax cable provides specs for this wire on its RF coax cable LMR-LW600 datasheet.

LMR-LW600 cable is part of more than one million RF, microwave parts in stock at Pasternack. This Times Microwave low loss and light weight LMR-LW600 coax cable is ready to buy and can be shipped worldwide. Pasternack also maintains a wide selection of other radio frequency coaxial cable types that ship same-day from our warehouse as with the rest of our other RF/microwave components.

* LMR™ is a trademark of Times Microwave Systems.

Electrical Specifications

Description	Minimum	Typical	Maximum	Units
Frequency Range	DC		8	GHz
Impedance		50		Ohms
Velocity of Propagation		85		%
Time Delay		1.17 [3.84]		ns/ft [ns/m]
Shielding Effectiveness	90			dB
Dielectric Withstanding Voltage (DC)			4,000	Vdc
Jacket Spark			8,000	Vrms

Click the following link (or enter part number in "SEARCH" on website) to obtain additional part information including price, inventory and certifications: [LMR-LW600 Light weight version of the 600 series Low Loss Coax LMR-LW600](#)



LMR-LW600 Light weight version of the 600 series Low Loss Coax

RF Cables Technical Data Sheet



LMR-LW600

Inner Conductor DC Resistance	0.53	Ohms/1000ft
Outer Conductor DC Resistance	4.4	Ohms/1000ft
Nominal Capacitance	23.4 [76.77]	pF/ft [pF/m]
Nominal Inductance	0.058 [0.19]	uH/ft [uH/m]
Input Power (Peak)	40	kWatts

Performance by Frequency Band

Description	F1	F2	F3	F4	F5	Units
Frequency	0.05	0.15	0.45	0.9	1.5	GHz
Attenuation, Typ	0.5	1	1.7	2.5	3.3	dB/100ft
	1.64	3.28	5.58	8.2	10.83	dB/100m
Input Power (CW), Max	4,240	2,410	1,350	930	700	Watts

Description	F6	F7	F8	F9	F10	Units
Frequency	1.8	2	2.5	5.8	8	GHz
Attenuation, Typ	3.7	3.9	4.4	7.3	8.8	dB/100ft
	12.14	12.8	14.44	23.95	28.87	dB/100m
Input Power (CW), Max	630	590	520	320	260	Watts

Mechanical Specifications

Diameter	0.59 in [14.99 mm]
Weight	0.099 lbs/ft [0.15 kg/m]
Min. Bend Radius (Installation)	1.5 in [38.1 mm]
Min. Bend Radius (Repeated)	6 in [152.4 mm]
Bending Moment	2.75 lbs-ft [3.73 N-m]
Tensile Strength	260 lbs [117.93 kg]
Flat Plate Crush	60 lbs/in [1.07 kg/mm]

Construction Specifications

Description	Material and Plating	Diameter
Inner Conductor	Copper, 1 Strand	0.176 in [4.47 mm]
Conductor Type	Solid	

Click the following link (or enter part number in "SEARCH" on website) to obtain additional part information including price, inventory and certifications: [LMR-LW600 Light weight version of the 600 series Low Loss Coax LMR-LW600](#)



LMR-LW600 Light weight version of the 600 series Low Loss Coax

RF Cables Technical Data Sheet



LMR-LW600

Dielectric	Foam PE	0.455 in [11.56 mm]
First Shield	Aluminum Tape	[]
Second Shield	Aluminium	[]
Jacket	PE, Black	0.59 in [14.99 mm]

Environmental Specifications

Temperature

Operating Range	-40 to +85 deg C
Installation Range	-40 to +85 deg C
Storage Range	-70 to +85 deg C

Compliance Certifications (see [product page](#) for current document)

Plotted and Other Data

Notes:

LMR-LW600 Light weight version of the 600 series Low Loss Coax from Pasternack Enterprises has same day shipment for domestic and International orders. Our RF, microwave and millimeter wave products maintain a 99.4% availability and are part of the broadest selection in the industry.

Click the following link (or enter part number in "SEARCH" on website) to obtain additional part information including price, inventory and certifications: [LMR-LW600 Light weight version of the 600 series Low Loss Coax LMR-LW600](#)

URL: <https://www.pasternack.com/low-loss-flexible-lmr-lw600-pe-jacket-aluminum-tape-over-aluminium-outer-conductor-double-shielded-lmr-lw600-p.aspx>

The information contained in this document is accurate to the best of our knowledge and representative of the part described herein. It may be necessary to make modifications to the part and/or the documentation of the part, in order to implement improvements. Pasternack reserves the right to make such changes as required. Unless otherwise stated, all specifications are nominal. Pasternack does not make any representation or warranty regarding the suitability of the part described herein for any particular purpose, and Pasternack does not assume any liability arising out of the use of any part or documentation.

REVISIONS		
REV.	DESCRIPTION	DATE
A	INITIAL RELEASE	06-04-2021
		APPROVED
		SELLIS

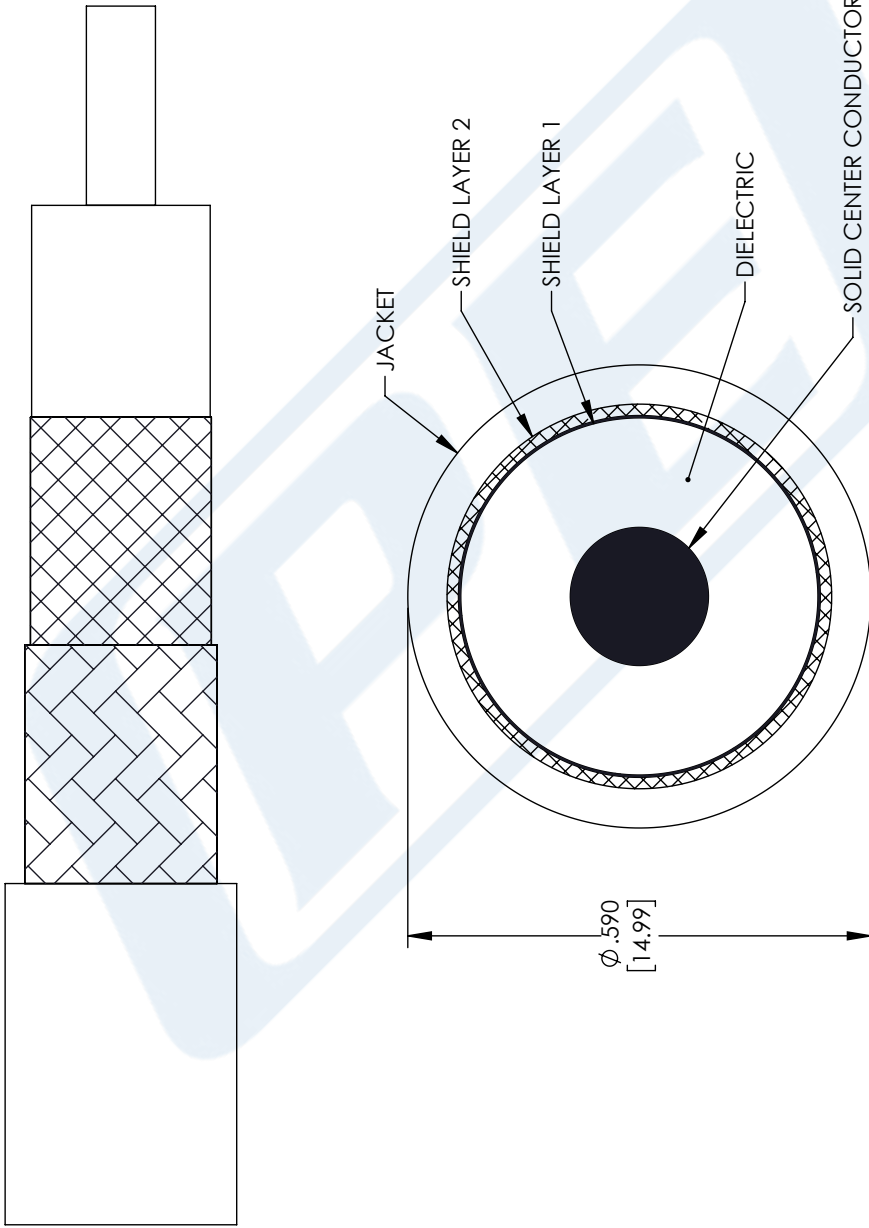

UNLESS OTHERWISE SPECIFIED
 LEADING DIMENSIONS ARE INCHES
 DIMENSIONS IN [] ARE MILLIMETERS

TOLERANCES:

.X = ±.2 [.508] FRACTIONS ± 1/32
 .XX = ±.02 [.51] ANGLES ± 1°
 .XXX = ±.005 [.13]

CABLE LENGTH (L) TOLERANCES:

L ≤ 12 [305] = +1 [25] / -0
 12 [305] < L ≤ 60 [1524] = +2 [51] / -0
 60 [1524] < L ≤ 120 [3048] = +4 [102] / -0
 120 [3048] < L ≤ 300 [7620] = +6 [152] / -0
 300 [7620] < L = +5% / -0

ALL DIMENSIONS SHOWN
 ARE FOR REFERENCE ONLY.

PE PASTERNAK
 an INFINITI brand

Pasternack Enterprises, Inc.
 P. O. Box 16759, Irvine, CA 92623.
 Phone: 1.949.261.1920 | 1.866.727.8376
 Fax: 1.949.261.7451
 Website: www.pasternack.com
 E-mail: sales@pasternack.com

SIZE [CAGE CODE] DRAWN BY ITEM NO.
 A 53919 MVEERAPPAN LMR-LW600

THIRD-ANGLE PROJECTION

THE INFORMATION AND DESIGN IN THIS DOCUMENT IS THE PROPERTY OF PASTERNAK CORPORATION ALL RIGHTS RESERVED.

SHEET 1 OF 1

SCALE N/A

REV A

THESE COMMODITIES, TECHNOLOGY OR SOFTWARE WERE EXPORTED FROM THE UNITED STATES IN ACCORDANCE WITH THE EXPORT ADMINISTRATION REGULATIONS. DIVERSION CONTRARY TO U.S. LAW PROHIBITED.