



SMA Male Connector Solder Attachment for PE-SR405AL, PE-SR405FL, RG405

RF Connectors Technical Data Sheet

PE4005

Configuration

- SMA Male Connector
- MIL-STD-348A
- 50 Ohms
- Straight Body Geometry
- PE-SR405AL, PE-SR405FL, RG405 Interface Type
- Solder/Solder Attachment
- 5/16 inch Hex

Features

- Max. Operating Frequency 18 GHz
- Good VSWR of 1.5:1
- Gold Plated Brass Contact
- 50 µin minimum contact plating

Applications

- General Purpose Test
- Custom Cable Assemblies

Description

Pasternack's PE4005 SMA male connector with solder/solder attachment for PE-SR405AL, PE-SR405FL and RG405 is part of our full line of RF components available for same-day shipping. Our SMA male connector operates up to a maximum frequency of 18 GHz and offers good VSWR of 1.5:1.

Our SMA male connector PE4005 datasheet specifications and drawing with dimensions are shown below in this PDF. Pasternack's broad catalog of RF, microwave and millimeter wave connectors allows designers to configure and customize their signal connections however they like. Whether the need is to provide an I/O for a board design, or simply create a custom cable assembly configuration, Pasternack has the right connector for the job. Pasternack can also expertly build your custom cable assemblies for you and ship same-day.

Electrical Specifications

Description	Minimum	Typical	Maximum	Units
Frequency Range	DC		18	GHz
VSWR			1.5:1	
Operating Voltage (AC)			335	Vrms

Mechanical Specifications

Size

Length	0.406 in [10.31 mm]
Width/Dia.	0.315 in [8.00 mm]
Weight	0.011 lbs [4.99 g]
Mating Cycles	500 Cycles
Mating Torque	3 to 5 in-lbs [0.34 to 0.57 Nm]

Click the following link (or enter part number in "SEARCH" on website) to obtain additional part information including price, inventory and certifications: [SMA Male Connector Solder Attachment for PE-SR405AL, PE-SR405FL, RG405 PE4005](#)



SMA Male Connector Solder Attachment for PE-SR405AL, PE-SR405FL, RG405

RF Connectors Technical Data Sheet

PE4005

Material Specifications

Description	Material	Plating
Contact	Brass	Gold 50 µin minimum
Insulation	PTFE	
Body	Stainless Steel	Gold 10 µin minimum
Coupling Nut	Brass	Nickel 100 µin minimum

Environmental Specifications

Temperature

Operating Range

-65 to +165 deg C

Compliance Certifications (see [product page](#) for current document)

Plotted and Other Data

Notes:

SMA Male Connector Solder Attachment for PE-SR405AL, PE-SR405FL, RG405 from Pasternack Enterprises has same day shipment for domestic and International orders. Our RF, microwave and millimeter wave products maintain a 99% availability and are part of the broadest selection in the industry.

Click the following link (or enter part number in "SEARCH" on website) to obtain additional part information including price, inventory and certifications: [SMA Male Connector Solder Attachment for PE-SR405AL, PE-SR405FL, RG405 PE4005](#)

URL: <https://www.pasternack.com/sma-male-pe-sr405al-pe-sr405fl-pe-sr405flj-pe-sr405tn-rg405-connector-pe4005-p.aspx>

The information contained in this document is accurate to the best of our knowledge and representative of the part described herein. It may be necessary to make modifications to the part and/or the documentation of the part, in order to implement improvements. Pasternack reserves the right to make such changes as required. Unless otherwise stated, all specifications are nominal. Pasternack does not make any representation or warranty regarding the suitability of the part described herein for any particular purpose, and Pasternack does not assume any liability arising out of the use of any part or documentation.

PE4005 CAD Drawing

SMA Male Connector Solder Attachment for PE-SR405AL, PE-SR405FL, RG405

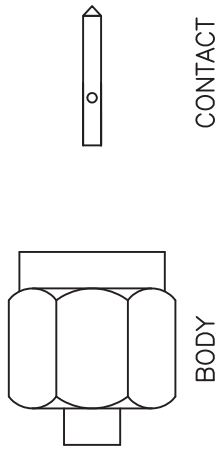

CONTACT

BODY

ASSEMBLY PROCEDURES

1. STRIP CABLE AS SHOWN. DO NOT NICK CENTER CONDUCTOR.

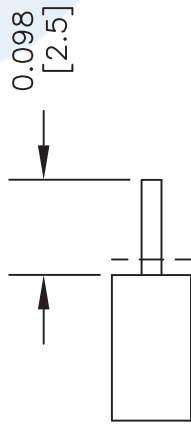

2. PLACE CONTACT OVER CENTER CONDUCTOR AS SHOWN. SOLDER CONTACT TO CENTER CONDUCTOR AS SHOWN.

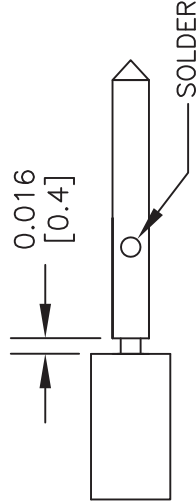

3. INSERT CABLE AND CONTACT INTO CONNECTOR BODY UNTIL FULLY ENGAGED. SOLDER BODY TO CABLE.

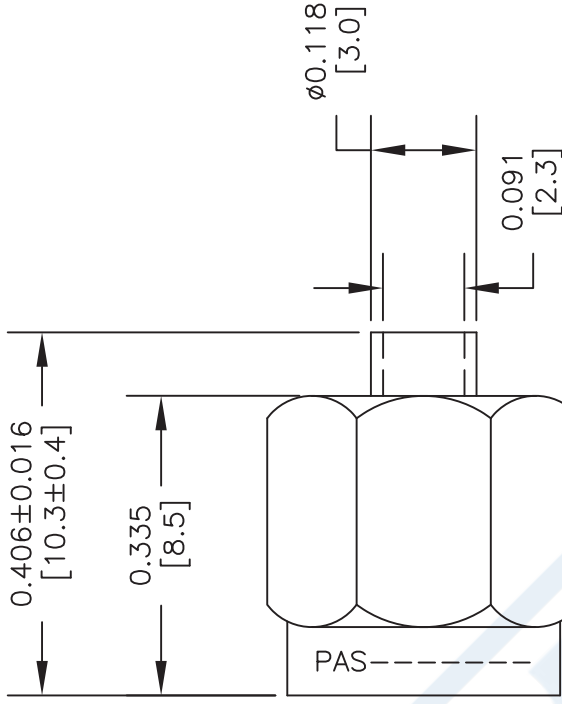
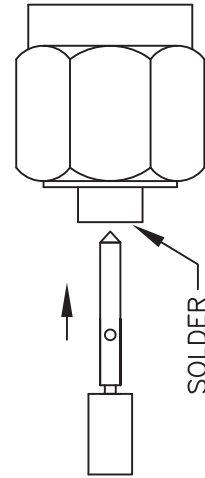

"PASTERNAK
PE4005"

STANDARD TOLERANCES	
.X	±0.2
.XX	±0.1
.XXX	±0.05

*STANDARD TOLERANCES APPLY ONLY TO DIMENSIONS IN INCHES

NOTES:

1. UNLESS OTHERWISE SPECIFIED ALL DIMENSIONS ARE NOMINAL.
2. ALL SPECIFICATIONS ARE SUBJECT TO CHANGE WITHOUT NOTICE AT ANY TIME.
3. DIMENSIONS ARE IN INCHES [mm].

DWG TITLE

PE4005

FSCM NO. 53919

CAD FILE

071316

SCALE N/A

SIZE A

2233

PE PASTERNAK
THE ENGINEER'S RF SOURCE

Pasternack Enterprises, Inc.
P.O. Box 16759 | Irvine | CA | 92623
Phone: (949) 261-1920 | Fax: (949) 261-7451
Website: www.pasternack.com | E-Mail: sales@pasternack.com



SMA Male Connector Solder Attachment for
RG405, RG405 Tinned, PE-SR405AL, PE-
SR405FL, PE-SR405FLJ, PE-SR405TN

RF Connectors
Technical Data Sheet

PE45480

Configuration

- SMA Male Connector
- 50 Ohms
- Straight Body Geometry
- Connector Interface Types: RG405, RG405 Tinned, PE-SR405AL, PE-SR405FL, PE-SR405FLJ, PE-SR405TN

Features

- Max. Operating Frequency 26.5 GHz
- Excellent VSWR of 1.14:1
- Gold Plated Beryllium Copper Contact
- Contact plating according to ASTM-B488

Applications

- General Purpose Test
- Custom Cable Assemblies

Description

Pasternack's PE45480 SMA male connector with solder attachment for RG405, RG405 Tinned, PE-SR405AL, PE-SR405FL, PE-SR405FLJ and PE-SR405TN is part of our full line of RF components available for same-day shipping. Our SMA male connector operates up to a maximum frequency of 26.5 GHz and offers excellent VSWR of 1.14:1.

Our SMA male connector PE45480 datasheet specifications and drawing with dimensions are shown below in this PDF. Pasternack's broad catalog of RF, microwave and millimeter wave connectors allows designers to configure and customize their signal connections however they like. Whether the need is to provide an I/O for a board design, or simply create a custom cable assembly configuration, Pasternack has the right connector for the job. Pasternack can also expertly build your custom cable assemblies for you and ship same-day.

Electrical Specifications

Description	Minimum	Typical	Maximum	Units
Frequency Range	DC		26.5	GHz
VSWR			1.14:1	
Dielectric Withstanding Voltage (AC)			1,000	Vrms
High Potential Voltage			670	Vrms
Corona Discharge			250	Vrms
Insulation Resistance	5,000			MOhms
RF Leakage	-90			dB

Click the following link (or enter part number in "SEARCH" on website) to obtain additional part information including price, inventory and certifications: [SMA Male Connector Solder Attachment for RG405, RG405 Tinned, PE-SR405AL, PE-SR-405FL, PE-SR405FLJ, PE-SR405TN PE45480](#)



SMA Male Connector Solder Attachment for
RG405, RG405 Tinned, PE-SR405AL, PE-
SR405FL, PE-SR405FLJ, PE-SR405TN

RF Connectors
Technical Data Sheet

PE45480

Performance by Frequency

Description	F1	F2	F3	F4	F5	Units
Frequency Range	DC to 18	18 to 26.5				GHz
VSWR, Max	1.11:1	1.14:1				

Electrical Specification Notes:
Insertion Loss = 0.04*SQRT(Fghz) dB

Mechanical Specifications

Mating Cycles 500 Cycles
Mating Torque 7 to 10 in-lbs [0.79 to 1.13 Nm]

Material Specifications

Description	Material	Plating
Contact	Beryllium Copper	Gold ASTM-B488
Insulation	PTFE	
Body	Beryllium Copper	Gold ASTM-B488
Coupling Nut	Steel	
Gasket	Silicone Rubber	

Environmental Specifications

Temperature
Operating Range -65 to +165 deg C
Shock MIL-STD-202, Method 213, Condition I
Vibration MIL-STD-202, Method 204, Condition D
Thermal Shock MIL-STD-202, Method 107, Condition B

Compliance Certifications (see [product page](#) for current document)

Plotted and Other Data

Notes:

Click the following link (or enter part number in "SEARCH" on website) to obtain additional part information including price, inventory and certifications: [SMA Male Connector Solder Attachment for RG405, RG405 Tinned, PE-SR405AL, PE-SR-405FL, PE-SR405FLJ, PE-SR405TN PE45480](#)



SMA Male Connector Solder Attachment for
RG405, RG405 Tinned, PE-SR405AL, PE-
SR405FL, PE-SR405FLJ, PE-SR405TN

RF Connectors
Technical Data Sheet

PE45480

Assembly Instruction

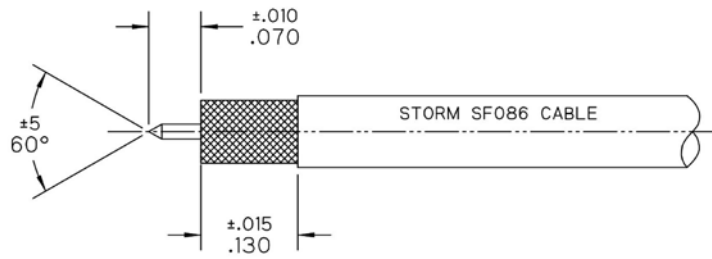

STEP 1:

- TRIM CABLE TO EXPOSE CENTER CONDUCTOR AND BRAID AS SHOWN.

STEP 2:

- INSERT CABLE INTO CONNECTOR UNTIL CENTER CONDUCTOR PLUGS IN AND CABLE FULLY SEATS IN CONNECTOR BORE.
- SOLDER BRAID TO BODY WHERE SHOWN APPLYING HEAT TO SHORT BODY TAIL SHOULDER INSIDE COUPLING NUT.

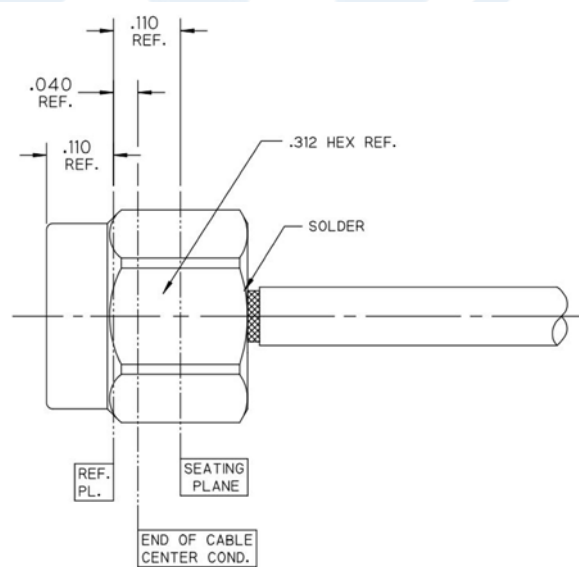

Click the following link (or enter part number in "SEARCH" on website) to obtain additional part information including price, inventory and certifications: [SMA Male Connector Solder Attachment for RG405, RG405 Tinned, PE-SR405AL, PE-SR-405FL, PE-SR405FLJ, PE-SR405TN PE45480](#)



SMA Male Connector Solder Attachment for
RG405, RG405 Tinned, PE-SR405AL, PE-
SR405FL, PE-SR405FLJ, PE-SR405TN

RF Connectors Technical Data Sheet

PE45480

SMA Male Connector Solder Attachment for RG405, RG405 Tinned, PE-SR405AL, PE-SR405FL, PE-SR405FLJ, PE-SR405TN from Pasternack Enterprises has same day shipment for domestic and International orders. Our RF, microwave and millimeter wave products maintain a 99.4% availability and are part of the broadest selection in the industry.

Click the following link (or enter part number in "SEARCH" on website) to obtain additional part information including price, inventory and certifications: [SMA Male Connector Solder Attachment for RG405, RG405 Tinned, PE-SR405AL, PE-SR405FL, PE-SR405FLJ, PE-SR405TN PE45480](https://www.pasternack.com/sma-male-rg405-rg405-tinned-connector-pe45480-p.aspx)

URL: <https://www.pasternack.com/sma-male-rg405-rg405-tinned-connector-pe45480-p.aspx>

The information contained in this document is accurate to the best of our knowledge and representative of the part described herein. It may be necessary to make modifications to the part and/or the documentation of the part, in order to implement improvements. Pasternack reserves the right to make such changes as required. Unless otherwise stated, all specifications are nominal. Pasternack does not make any representation or warranty regarding the suitability of the part described herein for any particular purpose, and Pasternack does not assume any liability arising out of the use of any part or documentation.

PE45480 CAD Drawing

SMA Male Connector Solder Attachment for RG405, RG405 Tinned,
PE-SR405AL, PE-SR405FL, PE-SR405FLJ, PE-SR405TN

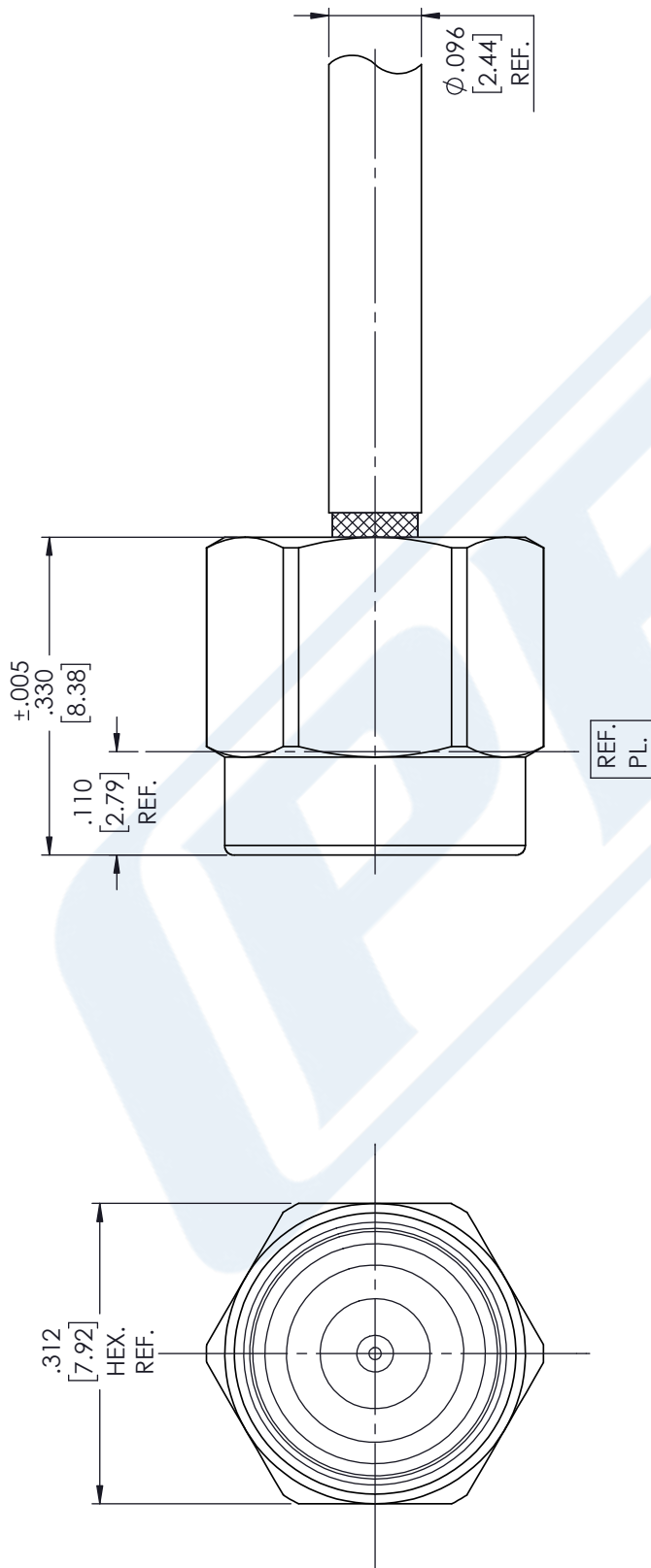

STANDARD TOLERANCES

- .X ±0.2
- .XX ±0.01
- .XXX ±0.005

*STANDARD TOLERANCES APPLY ONLY TO DIMENSIONS IN INCHES
 NOTES: DISTANCE FROM END OF CABLE CENTER COND. TO REF. PL. IS .040



Pasternack Enterprises, Inc.
 P.O. Box 16759 | Irvine | CA | 92623
Phone: (949) 261-1920 | **Fax:** (949) 261-7451
Website: www.pasternack.com | **E-Mail:** sales@pasternack.com

DWG TITLE

PE45480

CAGE CODE 53919

NOTES:
 1. UNLESS OTHERWISE SPECIFIED ALL DIMENSIONS ARE NOMINAL.
 2. ALL SPECIFICATIONS ARE SUBJECT TO CHANGE WITHOUT NOTICE AT ANY TIME.
 3. DIMENSIONS ARE IN INCHES [mm].

CAD FILE 07/26/18

SCALE N/A

SIZE A

CN2379

086 Semi-rigid Coax Cable with Copper Outer Conductor

TECHNICAL DATA SHEET

RG405/U

086 Semi-rigid Coax Cable with Copper Outer Conductor

Configuration

Inner Conductor Material and Plating	Copper Clad Steel, Silver
Dielectric Type	PTFE
Shield Materials	Copper
Jacket Material and Color	Tan

Electrical Specifications

Impedance, Ohms	50
Maximum Operating Frequency, GHz	40
Dielectric Withstanding Voltage, Vrms	5,000

Electrical Specifications by Frequency

Frequency 1

Frequency, MHz	1000
Attenuation, dB/100ft [dB/100m]	22 [72.18]
Power Handling, Watts	130

Frequency 2

Frequency, GHz	10
Attenuation, dB/100ft [dB/100m]	80 [262.47]
Power Handling, Watts	35

Frequency 3

Frequency, GHz	20
Attenuation, dB/100ft [dB/100m]	120 [393.7]
Power Handling, Watts	20

Mechanical Specifications

Temperature

Operating Range, deg C	-55 to +125
------------------------	-------------

Inner Conductor

Number of Strands	1
Material	Copper Clad Steel
Plating	Silver
Diameter, in [mm]	0.02 [0.51]

Dielectric:

Type	PTFE
Diameter, in [mm]	0.066 [1.68]

Click the following link (or enter part number in "SEARCH" on website) to obtain additional part information including price, inventory and certifications: [086 Semi-rigid Coax Cable with Copper Outer Conductor RG405/U](#)

The information contained in this document is accurate to the best of our knowledge and representative of the part described herein. It may be necessary to make modifications to the part and/or the documentation of the part, in order to implement improvements. Pasternack reserves the right to make such changes as required. Unless otherwise stated, all specifications are nominal.

086 Semi-rigid Coax Cable with Copper Outer Conductor

TECHNICAL DATA SHEET

RG405/U

Shield:

Number of	1
Material 1	Copper
Diameter, in [mm]	0.087 [2.21]

Jacket:

Color	Tan
One Time Minimum Bend Radius, in [mm]	0.05 [1.27]
Weight, lbs/ft [Kg/m]	0.015 [0.02]

Compliance Certifications (visit www.Pasternack.com for current document)

RoHS Compliant	Yes
----------------	-----

Plotted and Other Data

Notes: Values at 25 °C, sea level

086 Semi-rigid Coax Cable with Copper Outer Conductor from Pasternack Enterprises has same day shipment for domestic and International orders. Our RF, microwave and fiber optic products maintain a 99% availability and are part of the broadest selection in the industry.

Click the following link (or enter part number in "SEARCH" on website) to obtain additional part information including price, inventory and certifications: [086 Semi-rigid Coax Cable with Copper Outer Conductor RG405/U](#)

URL: <http://www.pasternack.com/semirigid-0.085-rg405-50-ohm-coax-cable-copper-rg405-u-p.aspx>

The information contained in this document is accurate to the best of our knowledge and representative of the part described herein. It may be necessary to make modifications to the part and/or the documentation of the part, in order to implement improvements. Pasternack reserves the right to make such changes as required. Unless otherwise stated, all specifications are nominal.

RG405/U CAD Drawing

086 Semi-rigid Coax Cable with Copper Outer Conductor



NOTES:
 1. UNLESS OTHERWISE SPECIFIED ALL DIMENSIONS ARE NOMINAL.
 2. ALL SPECIFICATIONS ARE SUBJECT TO CHANGE WITHOUT NOTICE AT ANY TIME.
 3. DIMENSIONS ARE IN INCHES [mm].

DWG TITLE
RG405/U

FSCM NO. 53919

CAD FILE 022908

SCALE N/A

SIZE A

2233

PE PASTERNAK®
 Pasternack Enterprises, Inc.
 P.O. Box 16759 | Irvine | CA | 92623
Phone: (949) 261-1920 | **Fax:** (949) 261-7451
Website: www.pasternack.com | **E-Mail:** sales@pasternack.com