



SMA Male Right Angle Connector Clamp/Solder Attachment for RG58, RG55, RG142, RG223, RG303, RG400, LMR-195, PE-C195

RF Connectors
Technical Data Sheet

PE45048

Configuration

- SMA Male Connector
- MIL-STD-348
- 50 Ohms
- Right Angle Body Geometry
- Connector Interface Types: RG58, RG55, RG142, RG223, RG303, RG400, LMR-195, PE-C195
- 5/16 inch Hex

Features

- Max. Operating Frequency 12.44 GHz
- Gold over Nickel Plated Brass Contact
- Contact plating according to MIL-G-45204

Applications

- General Purpose Test
- Custom Cable Assemblies

Description

Pasternack's PE45048 SMA male right angle connector with clamp/solder attachment for RG58, RG55, RG142, RG223, RG303, RG400, LMR-195 and PE-C195 is part of our full line of RF components available for same-day shipping. Our SMA male connector operates up to a maximum frequency of 12.44 GHz. Its right angle body geometry allows for easier connections in tight spaces.

Our SMA male right angle connector PE45048 datasheet specifications and drawing with dimensions are shown below in this PDF. Pasternack's broad catalog of RF, microwave and millimeter wave connectors allows designers to configure and customize their signal connections however they like. Whether the need is to provide an I/O for a board design, or simply create a custom cable assembly configuration, Pasternack has the right connector for the job. Pasternack can also expertly build your custom cable assemblies for you and ship same-day.

Electrical Specifications

Description	Minimum	Typical	Maximum	Units
Frequency Range	DC		12.44	GHz
Operating Voltage (DC)			335	Vdc
Dielectric Withstanding Voltage (AC)			1,000	Vrms
Insulation Resistance	5,000			MOhms

Mechanical Specifications

Size	
Length	0.74 in [18.8 mm]
Width/Dia.	0.312 in [7.92 mm]
Height	0.69 in [17.53 mm]
Weight	0.015 lbs [6.8 g]

Click the following link (or enter part number in "SEARCH" on website) to obtain additional part information including price, inventory and certifications: [SMA Male Right Angle Connector Clamp/Solder Attachment for RG58, RG55, RG142, RG223, RG303, RG400, LMR-195, PE-C195 PE45048](#)



SMA Male Right Angle Connector Clamp/Solder Attachment for RG58, RG55, RG142, RG223, RG303, RG400, LMR-195, PE-C195

RF Connectors
Technical Data Sheet

PE45048

Material Specifications

Description	Material	Plating
Contact	Brass	Gold over Nickel MIL-G-45204
Insulation	PTFE	
Body	Brass	Nickel QQ-N-290
Coupling Nut	Brass	Nickel QQ-N-290

Environmental Specifications

Temperature

Operating Range

-65 to +165 deg C

Compliance Certifications (see [product page](#) for current document)

Plotted and Other Data

Notes:

SMA Male Right Angle Connector Clamp/Solder Attachment for RG58, RG55, RG142, RG223, RG303, RG400, LMR-195, PE-C195 from Pasternack Enterprises has same day shipment for domestic and International orders. Our RF, microwave and millimeter wave products maintain a 99.4% availability and are part of the broadest selection in the industry.

Click the following link (or enter part number in "SEARCH" on website) to obtain additional part information including price, inventory and certifications: [SMA Male Right Angle Connector Clamp/Solder Attachment for RG58, RG55, RG142, RG223, RG303, RG400, LMR-195, PE-C195 PE45048](#)

URL: <https://www.pasternack.com/sma-male-rg58-rg55-rg223-rg303-rg400-lmr-195-connector-pe45048-p.aspx>

The information contained in this document is accurate to the best of our knowledge and representative of the part described herein. It may be necessary to make modifications to the part and/or the documentation of the part, in order to implement improvements. Pasternack reserves the right to make such changes as required. Unless otherwise stated, all specifications are nominal. Pasternack does not make any representation or warranty regarding the suitability of the part described herein for any particular purpose, and Pasternack does not assume any liability arising out of the use of any part or documentation.

PE45048 CAD Drawing

SMA Male Right Angle Connector Clamp/Solder Attachment for RG58, RG55, RG142, RG223, RG303, RG400, LMR-195, PE-C195

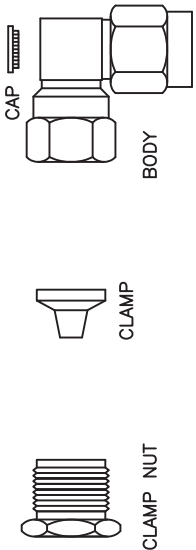

ASSEMBLY PROCEDURES

1. SLIDE NUT ONTO CABLE AS SHOWN. CUT CABLE SQUARE.

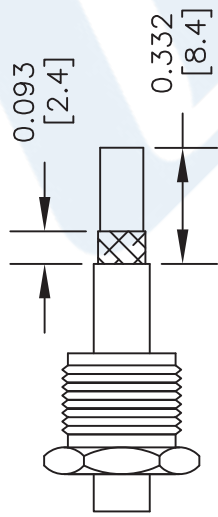

2. SLIDE CLAMP OVER DIELECTRIC AND UNDER BRAID UNTIL JACKET STOPS AGAINST SHOULDER. TWO SLITS IN THE JACKET 180° APART.

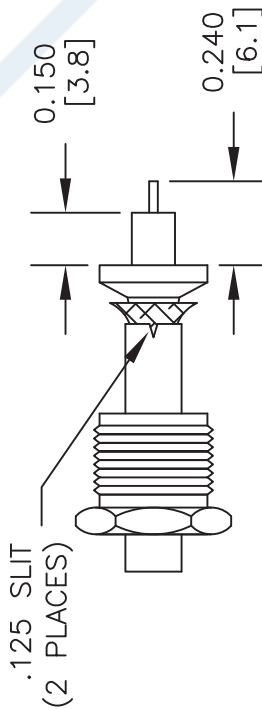

3. SLIDE ASSEMBLY INTO REAR OF BODY, WITH CENTER CONDUCTOR STARTING INTO SLOT OF CONTACT.

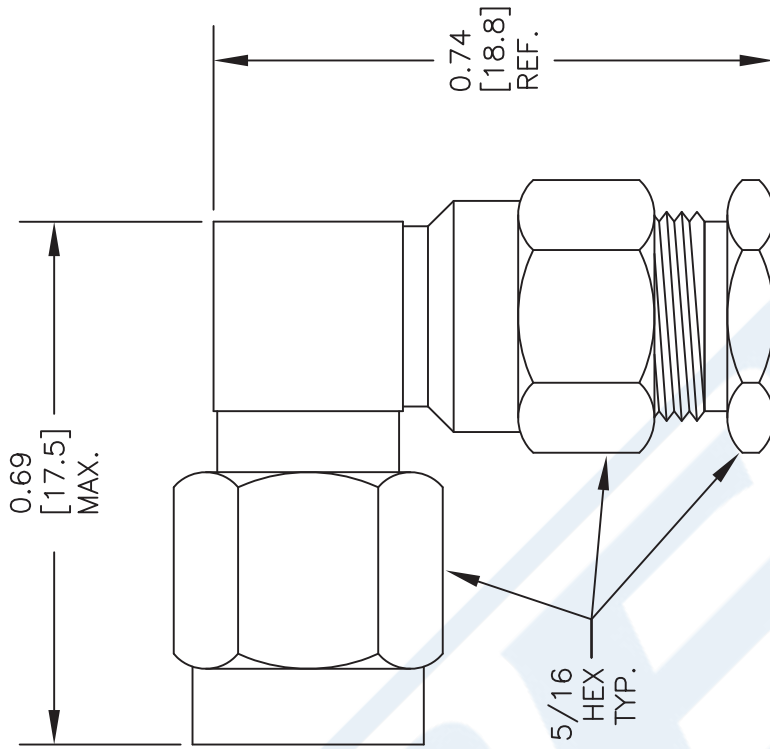
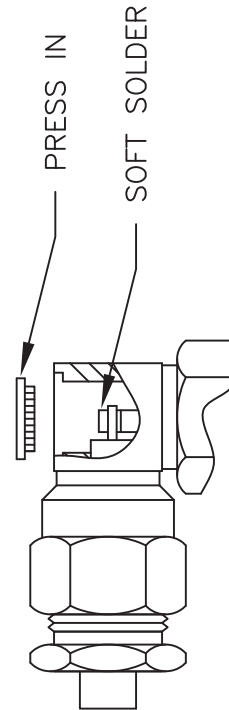

DWG TITLE

PE45048

NOTES:
 1. UNLESS OTHERWISE SPECIFIED ALL DIMENSIONS ARE NOMINAL.
 2. ALL SPECIFICATIONS ARE SUBJECT TO CHANGE WITHOUT NOTICE AT ANY TIME.
 3. DIMENSIONS ARE IN INCHES [mm].
 4. FITS MIL-C-17 AND EQUIVALENT CABLES.

FSCM NO. 53919

CAD FILE 062615

SCALE N/A

SIZE A

2233

PE PASTERNAK
 THE ENGINEER'S RF SOURCE

Pasternack Enterprises, Inc.
 P.O. Box 16759 | Irvine | CA | 92623
 Phone: (949) 261-1920 | Fax: (949) 261-7451
 Website: www.pasternack.com | E-Mail: sales@pasternack.com



RP-SMA Male Right Angle Connector Solder Attachment
for RG58, RG55, RG141, RG142, RG223, RG400

RF Connectors
Technical Data Sheet

PE4782

Configuration

- SMA Male Reverse Polarity Connector
- 50 Ohms
- Right Angle Body Geometry
- RG58, RG55, RG141, RG142, RG223, RG400 Interface Type
- Solder/Solder Attachment

Features

- Reverse Polarity

Applications

- General Purpose Test
- Custom Cable Assemblies

Description

Pasternack's PE4782 RP SMA male right angle connector with solder/solder attachment for RG58, RG55, RG141, RG142, RG223 and RG400 is part of our full line of RF components available for same-day shipping. The male reverse polarity configuration uses a male connector body with a female inner contact receptacle. Its right angle body geometry allows for easier connections in tight spaces.

Our reverse polarity SMA male right angle connector PE4782 datasheet specifications and drawing with dimensions are shown below in this PDF. Pasternack's broad catalog of RF, microwave and millimeter wave connectors allows designers to configure and customize their signal connections however they like. Whether the need is to provide an I/O for a board design, or simply create a custom cable assembly configuration, Pasternack has the right connector for the job. Pasternack can also expertly build your custom cable assemblies for you and ship same-day.

Mechanical Specifications

Weight 0.018 lbs [8.16 g]

Material Specifications

Description	Material	Plating
Body	Brass	Nickel

Environmental Specifications

Compliance Certifications (see [product page](#) for current document)

Plotted and Other Data

Notes:

Click the following link (or enter part number in "SEARCH" on website) to obtain additional part information including price, inventory and certifications: [RP-SMA Male Right Angle Connector Solder Attachment for RG58, RG55, RG141, RG142, RG223, RG400 PE4782](#)



RP-SMA Male Right Angle Connector Solder Attachment for RG58, RG55, RG141, RG142, RG223, RG400

RF Connectors Technical Data Sheet

PE4782

RP-SMA Male Right Angle Connector Solder Attachment for RG58, RG55, RG141, RG142, RG223, RG400 from Pasternack Enterprises has same day shipment for domestic and International orders. Our RF, microwave and millimeter wave products maintain a 99.4% availability and are part of the broadest selection in the industry.

Click the following link (or enter part number in "SEARCH" on website) to obtain additional part information including price, inventory and certifications: [RP-SMA Male Right Angle Connector Solder Attachment for RG58, RG55, RG141, RG142, RG223, RG400 PE4782](https://www.pasternack.com/sma-male-reverse-polarity-rg58-rg55-rg141-rg142-rg223-rg400-connector-pe4782-p.aspx)

URL: <https://www.pasternack.com/sma-male-reverse-polarity-rg58-rg55-rg141-rg142-rg223-rg400-connector-pe4782-p.aspx>

The information contained in this document is accurate to the best of our knowledge and representative of the part described herein. It may be necessary to make modifications to the part and/or the documentation of the part, in order to implement improvements. Pasternack reserves the right to make such changes as required. Unless otherwise stated, all specifications are nominal. Pasternack does not make any representation or warranty regarding the suitability of the part described herein for any particular purpose, and Pasternack does not assume any liability arising out of the use of any part or documentation.

PE4782 CAD Drawing

RP-SMA Male Right Angle Connector Solder Attachment for
RG58, RG55, RG141, RG142, RG223, RG400

REVISIONS			
REV.	DESCRIPTION	DATE	APPROVED
1.1	PCR PE4782 20190416	04/27/19	J.GARCIA

RP SMA MALE

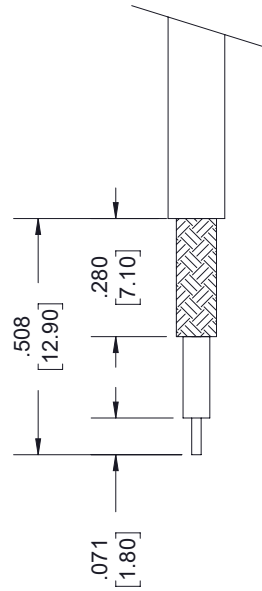
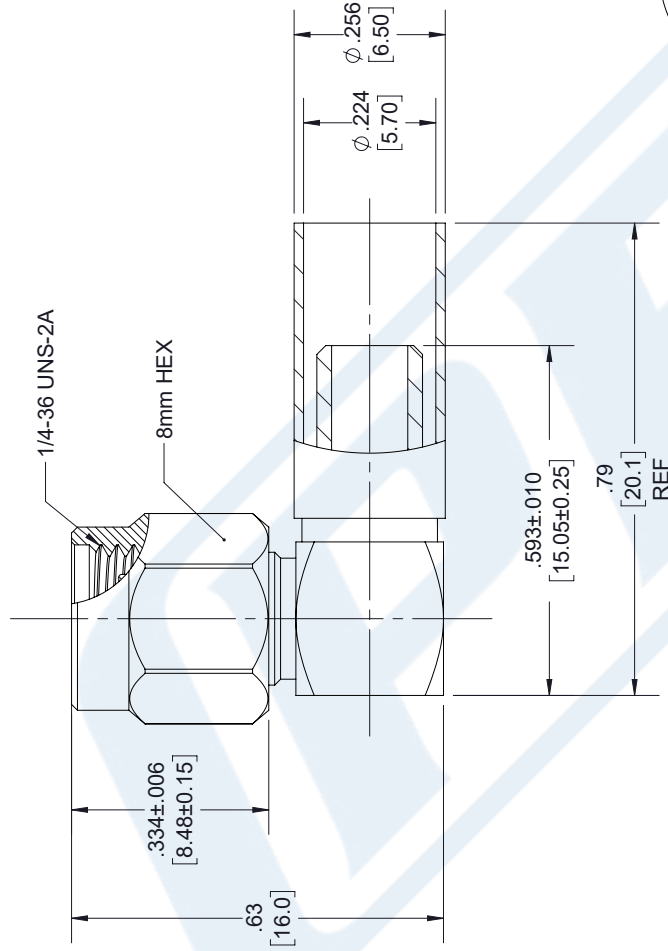

STRIPPING DIMENSIONS

NOTES:

- CABLE ATTACHMENT:
 - OUTER: SOLDER.
 - INNER: SOLDER.

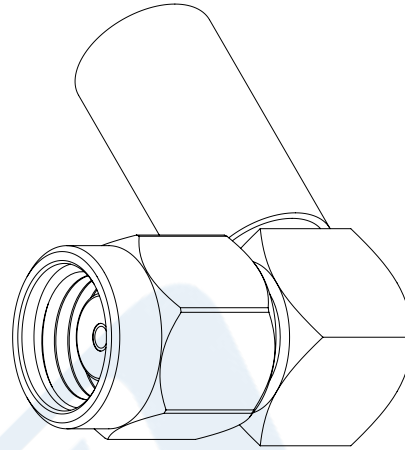

UNLESS OTHERWISE SPECIFIED LEADING DIMENSIONS ARE IN INCHES DIMENSIONS IN [] ARE MILLIMETERS	
TOLERANCES:	FRACTIONS
X±.2 [5.08]	±.132
.XX±.01 [.25]	ANGLES ± 1°
.XXX±.005 [.13]	
ALL DIMENSIONS SHOWN ARE FOR REFERENCE ONLY.	
THIRD-ANGLE PROJECTION	

PE PASTERNAK
an INFINITO brand

Pasternack Enterprises, Inc.
P.O. Box 16759, Irvine, CA 92623.
Phone: 1.949.261.1920 | 1.866.727.8376
Fax: 1.949.261.7451
www.pasternack.com | e-mail: sales@pasternack.com

SIZE: A CAGE: 53919 DRAWN BY: K.DANG PART NUMBER: PE4782 REV: 1.1

THE INFORMATION AND DESIGN IN THIS DOCUMENT IS THE PROPERTY OF PASTERNAK CORPORATION. ALL RIGHTS RESERVED.	
SHEET 1	OF 1
SCALE: N/A	

THESE COMMODITIES, TECHNOLOGY OR SOFTWARE WERE EXPORTED FROM THE UNITED STATES IN ACCORDANCE WITH THE EXPORT ADMINISTRATION REGULATIONS. DIVERSION CONTRARY TO U.S. LAW PROHIBITED.

LMR®-195

Flexible Low Loss Communications Coax

Ideal for...



- Jumper Assemblies in Wireless Communications Systems
 - Short Antenna Feeder runs
 - Any application (e.g. WLL, GPS, LMR, WLAN, WISP, WiMax, SCADA, Mobile Antennas) requiring an easily routed, low loss RF cable
 - Drop-in replacement for RG-58 and RG-142
- **LMR®** standard is a UV Resistant Polyethylene jacketed cable designed for 20-year service outdoor use. The bending and handling characteristics are significantly better than air-dielectric and corrugated hard-line cables.
 - **LMR® - DB** is identical to standard LMR plus has the advantage of being watertight. The addition of waterproofing compound in and around the foil/braid insures continuous reliable service should the jacket be inadvertently damaged during installation or in the future.
 - **LMR® - FR** is a non-halogen (non-toxic), low smoke, fire retardant cable designed for in-building runs that can be routed anywhere except air handling plenums. LMR-FR is UL/NEC & CSA rated 'CMR' and 'FT4' respectively, meets FAA FAR25 requirements and is MSHA-P for mining applications.
 - **LMR® - FR-PVC** is a general-purpose indoor cable and has a UL/NEC & CSA rating of 'CMR' and 'FT4' respectively. It is less expensive than LMR-FR, however it emits toxic fumes (HCL) and greater smoke density when burned.
 - **LMR® - PVC** is designed for low loss general-purpose applications and is somewhat more flexible than the standard polyethylene jacketed LMR.
 - **LMR® - PVC-W** is a white-jacketed version of LMR-PVC for marine and other applications where color compatibility is desired.
 - **LMR® - MA** is a flexible cable designed specifically for mobile antenna applications. It has a PVC jacket and un-bonded aluminum tape to facilitate end stripping with automated equipment.
 - **Flexibility** and bendability are hallmarks of the LMR-195 cable design. The flexible outer conductor enables the tightest bend radius available for any cable of similar size and performance.
 - **Low Loss** is another hallmark feature of LMR-195. Size for size LMR has the lowest loss of any flexible cable and comparable loss to semirigid hard-line cables.
 - **RF Shielding** is 50 dB greater than typical single shielded coax (40 dB). The multi-ply bonded foil outer conductor is rated conservatively at > 90 dB (i.e. >180 dB between two adjacent cables).
 - **Weatherability:** LMR-195 cables designed for outdoor exposure incorporate the best materials for UV resistance and have life expectancy in excess of 20 years.
 - **Connectors:** A wide variety of connectors are available for LMR-195 cable, including all common interface types, reverse polarity, and a choice of solder or non-solder center pins. Most LMR connectors employ crimp outer attachment using standard hex crimp sizes.
 - **Cable Assemblies:** All LMR-195 cable types are available as pre-terminated cable assemblies. Refer to the section on FlexTech for further details.

Part Description				Stock	
Part Number	Application	Jacket	Color	Code	
LMR-195	Outdoor	PE	Black	54110	
LMR-195-DB	Outdoor/Watertight	PE	Black	54113	
LMR-195-FR	Indoor/Outdoor Riser	CMR	FRPE	Black	54111
LMR-195-FR-W	Indoor/Outdoor Riser	CMR	FRPE	White	54158
LMR-195-FR-PVC	Indoor/Outdoor Riser	CMR	FRPVC	Black	54105
LMR-195-MA	Mobile Antennas	PVC	Black	54210	
LMR-195-PVC	General Purpose	PVC	Black	54215	
LMR-195-PVC-W	General Purpose	PVC	White	54199	

Construction Specifications			
Description	Material	In.	(mm)
Inner Conductor	Solid BC	0.037	(0.94)
Dielectric	Foam PE	0.110	(2.79)
Outer Conductor	Aluminum Tape	0.116	(2.95)
Overall Braid	Tinned Copper	0.139	(3.53)
Jacket	(see table above)	0.195	(4.95)

Mechanical Specifications			
Performance Property	Units	US	(metric)
Bend Radius: installation	in. (mm)	0.5	(12.7)
Bend Radius: repeated	in. (mm)	2.0	(50.8)
Bending Moment	ft-lb (N-m)	0.2	(0.27)
Weight	lb/ft (kg/m)	0.021	(0.03)
Tensile Strength	lb (kg)	40	(18.2)
Flat Plate Crush	lb/in. (kg/mm)	15	(0.27)

Electrical Specifications			
Performance Property	Units	US	(metric)
Velocity of Propagation	%	76	
Dielectric Constant	NA	1.56	
Time Delay	nS/ft (nS/m)	1.27	(4.17)
Impedance	ohms	50	
Capacitance	pF/ft (pF/m)	25.4	(83.3)
Inductance	uH/ft (uH/m)	0.064	(0.21)
Shielding Effectiveness	dB	>90	
DC Resistance			
Inner Conductor	ohms/1000ft (/km)	7.6	(24.9)
Outer Conductor	ohms/1000ft (/km)	4.9	(16.1)
Voltage Withstand	Volts DC	1000	
Jacket Spark	Volts RMS	3000	
Peak Power	kW	2.5	

Environmental Specifications		
Performance Property	°F	°C
Installation Temperature Range	-40/+185	-40/+85
Storage Temperature Range	-94/+185	-70/+85
Operating Temperature Range	-40/+185	-40/+85



Connectors

Interface	Description	Part Number	Stock Code	VSWR** Freq. (GHz)	Coupling Nut	Inner Contact Attach	Outer Contact Attach	Finish* Body /Pin	Length in (mm)	Width in (mm)	Weight lb (g)
N male	Straight Plug	TC-195-NM	3190-1555	<1.25:1 (2.5)	Knurl	Solder	Crimp	S/G	1.5 (38.1)	0.75 (19.1)	0.073 (33.1)
N male	Right Angle	TC-195-NMH-RA-D	3190-2425	<1.35:1 (6)	Hex/Knurl	Solder	Crimp	A/G	1.3 (32.1)	1.19 (30.1)	0.083 (37.5)
SMA male	Straight Plug	TC-195-SM	3190-1553	<1.25:1 (2.5)	Hex	Solder	Crimp	SS/G	1.0 (25.4)	0.32 (8.1)	0.015 (6.8)
TNC male	Straight Plug	TC-195-TM	3190-1554	<1.25:1 (2.5)	Knurl	Solder	Crimp	S/G	1.4 (35.6)	0.59 (15.0)	0.045 (20.4)

* Finish metals: N=Nickel, S=Silver, G=Gold, SS=Stainless Steel, A=Alloy **VSWR spec based on 3 foot cable with a connector pair

Install Tools

Type	Part Number	Stock Code	Description
Crimp Tool	CT-240/200/195/100	3190-667	Crimp tool for LMR-100,195, 200 and 240 connectors
Cutting Tool	CCT-01	3190-1544	Cable end flush cut tool
Deburr Tool	DBT-U	3192-001	Removes center conductor rough edges
Replacement Blade	RB-01	3190-1609	Replacement blade for cutting tool

