



SMA Male Connector Clamp/Solder Attachment  
for RG213, RG214, RG8, RG9, RG11, RG225,  
RG393, RG144, RG216, RG215

RF Connectors  
Technical Data Sheet

PE4332

**Configuration**

- SMA Male Connector
- MIL-STD-348A
- 50 Ohms
- Straight Body Geometry
- Connector Interface Types: RG213, RG214, RG8, RG9, RG11, RG225, RG393, RG144, RG216, RG215
- 5/16 inch Hex

**Features**

- Max. Operating Frequency 11 GHz
- Gold Plated Brass Contact
- 30 µin minimum contact plating

**Applications**

- General Purpose Test
- Custom Cable Assemblies

**Description**

Pasternack's PE4332 SMA male connector with clamp/solder attachment for RG213, RG214, RG8, RG9, RG11, RG225, RG393, RG144, RG216 and RG215 is part of our full line of RF components available for same-day shipping. Our SMA male connector operates up to a maximum frequency of 11 GHz.

Our SMA male connector PE4332 datasheet specifications and drawing with dimensions are shown below in this PDF. Pasternack's broad catalog of RF, microwave and millimeter wave connectors allows designers to configure and customize their signal connections however they like. Whether the need is to provide an I/O for a board design, or simply create a custom cable assembly configuration, Pasternack has the right connector for the job. Pasternack can also expertly build your custom cable assemblies for you and ship same-day.

**Electrical Specifications**

Description	Minimum	Typical	Maximum	Units
Frequency Range	DC		11	GHz
Operating Voltage (AC)			500	Vrms

**Mechanical Specifications**

<b>Size</b>	
Length	1.515 in [38.48 mm]
Width/Dia.	0.748 in [19.00 mm]
Weight	0.082 lbs [37.19 g]
Mating Torque	3 to 5 in-lbs [0.34 to 0.57 Nm]

Click the following link (or enter part number in "SEARCH" on website) to obtain additional part information including price, inventory and certifications: [SMA Male Connector Clamp/Solder Attachment for RG213, RG214, RG8, RG9, RG11, RG225, RG393, RG144, RG216, RG215 PE4332](#)



SMA Male Connector Clamp/Solder Attachment  
for RG213, RG214, RG8, RG9, RG11, RG225,  
RG393, RG144, RG216, RG215

RF Connectors  
Technical Data Sheet

PE4332

**Material Specifications**

Description	Material	Plating
Contact	Brass	Gold 30 µin minimum
Insulation	PTFE	
Body	Brass	Nickel 100 µin minimum
Coupling Nut	Brass	Nickel 100 µin minimum

**Mechanical Specification Notes:**

When attaching the connector to the cable use a clamp torque value of 60 to 65 in-lbs [6.78 to 7.34 Nm]

**Environmental Specifications**

**Temperature**

Operating Range -65 to +165 deg C

**Compliance Certifications** (see [product page](#) for current document)

**Plotted and Other Data**

Notes:

Click the following link (or enter part number in "SEARCH" on website) to obtain additional part information including price, inventory and certifications: [SMA Male Connector Clamp/Solder Attachment for RG213, RG214, RG8, RG9, RG11, RG225, RG393, RG144, RG216, RG215 PE4332](#)



SMA Male Connector Clamp/Solder Attachment  
for RG213, RG214, RG8, RG9, RG11, RG225,  
RG393, RG144, RG216, RG215

RF Connectors  
Technical Data Sheet

PE4332

**Assembly Instruction**

1. SLIDE CLAMP NUT (1), WASHER (2) & GASKET (3) OVER CABLE. STRIP CABLE AS SHOWN. DO NOT NICK BRAID WHILE CUTTING JACKET. TAPER END OF BRAID TO PERMIT ASSEMBLY OF BRAID CLAMP (4). SLIDE BRAID CLAMP (4) OVER BRAID & SEAT AGAINST CABLE.

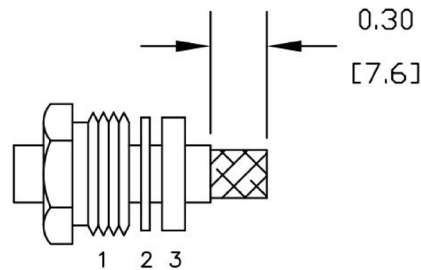

2. FORM BRAID OVER CLAMP NUT (4). TRIM BRAID BACK TO SHOULDER. CUT DIELECTRIC & CENTER CONDUCTOR TO DIMENSION SHOWN. DO NOT NICK CENTER CONDUCTOR. SOLDER CONTACT TO CENTER CONDUCTOR. REMOVE EXCESS SOLDER. DO NOT OVER HEAT DIELECTRIC. INSERT CABLE ASSEMBLY INTO BODY & TIGHTEN.

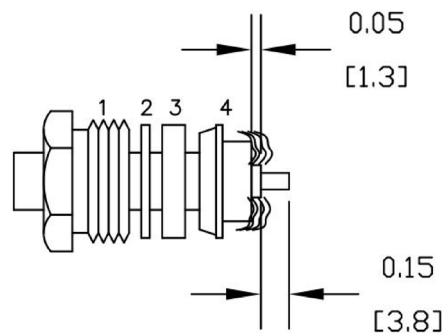

Click the following link (or enter part number in "SEARCH" on website) to obtain additional part information including price, inventory and certifications: [SMA Male Connector Clamp/Solder Attachment for RG213, RG214, RG8, RG9, RG11, RG225, RG393, RG144, RG216, RG215 PE4332](#)



SMA Male Connector Clamp/Solder Attachment  
for RG213, RG214, RG8, RG9, RG11, RG225,  
RG393, RG144, RG216, RG215

RF Connectors  
Technical Data Sheet

PE4332

SMA Male Connector Clamp/Solder Attachment for RG213, RG214, RG8, RG9, RG11, RG225, RG393, RG144, RG216, RG215 from Pasternack Enterprises has same day shipment for domestic and International orders. Our RF, microwave and millimeter wave products maintain a 99.4% availability and are part of the broadest selection in the industry.

Click the following link (or enter part number in "SEARCH" on website) to obtain additional part information including price, inventory and certifications: [SMA Male Connector Clamp/Solder Attachment for RG213, RG214, RG8, RG9, RG11, RG225, RG393, RG144, RG216, RG215 PE4332](https://www.pasternack.com/sma-male-standard-rg213-rg214-rg8-rg9-rg11-rg225-rg393-connector-pe4332-p.aspx)

URL: <https://www.pasternack.com/sma-male-standard-rg213-rg214-rg8-rg9-rg11-rg225-rg393-connector-pe4332-p.aspx>

The information contained in this document is accurate to the best of our knowledge and representative of the part described herein. It may be necessary to make modifications to the part and/or the documentation of the part, in order to implement improvements. Pasternack reserves the right to make such changes as required. Unless otherwise stated, all specifications are nominal. Pasternack does not make any representation or warranty regarding the suitability of the part described herein for any particular purpose, and Pasternack does not assume any liability arising out of the use of any part or documentation.

# PE4332 CAD Drawing

SMA Male Connector Clamp/Solder Attachment for RG213, RG214, RG8, RG9, RG11, RG225, RG393, RG144, RG216, RG215

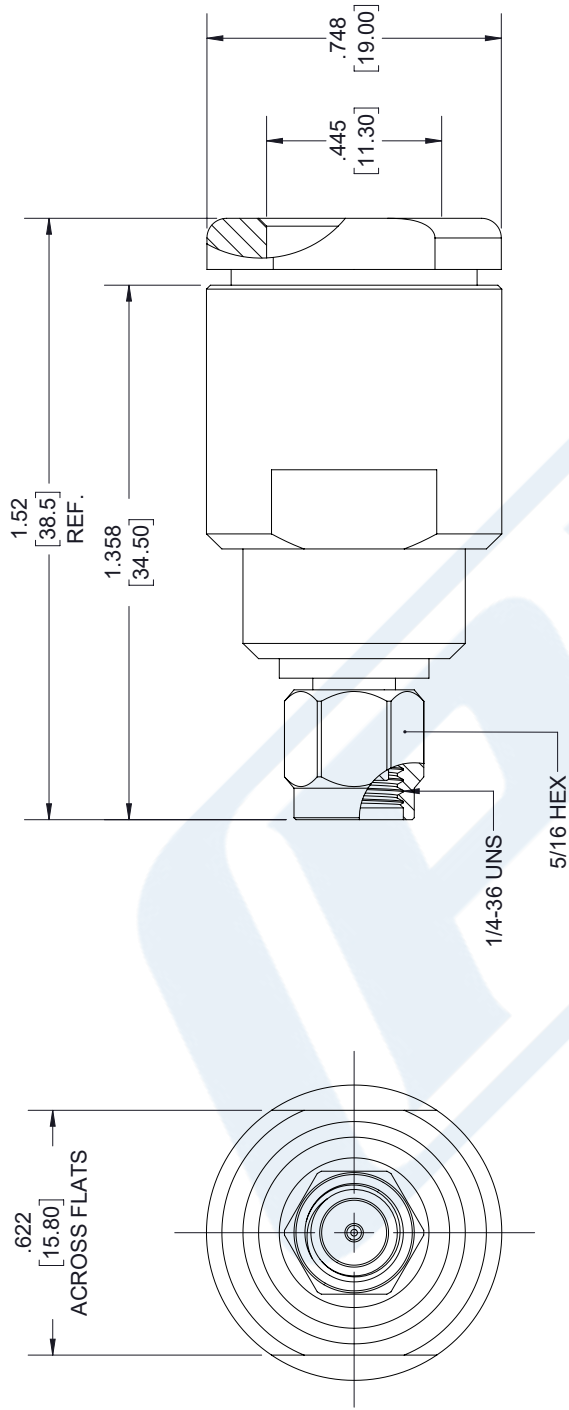

SMA MALE

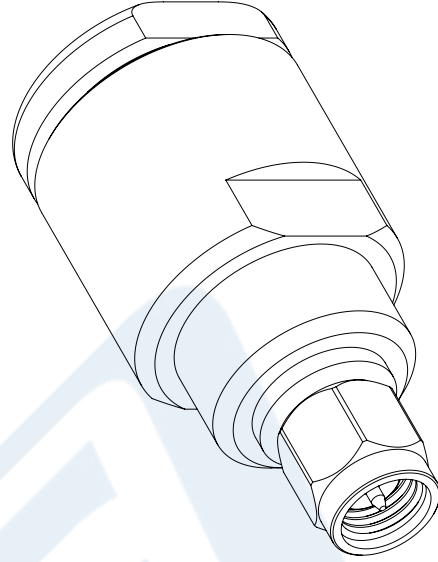

**STANDARD TOLERANCES**

- .X ±0.2
- .XX ±0.01
- .XXX ±0.005

\*STANDARD TOLERANCES APPLY ONLY TO DIMENSIONS IN INCHES



Pasternack Enterprises, Inc.  
 P.O. Box 16759 | Irvine | CA | 92623  
**Phone:** (949) 261-1920 | **Fax:** (949) 261-7451  
**Website:** [www.pasternack.com](http://www.pasternack.com) | **E-Mail:** [sales@pasternack.com](mailto:sales@pasternack.com)

DWG TITLE

PE4332

NOTES:  
 1. UNLESS OTHERWISE SPECIFIED ALL DIMENSIONS ARE NOMINAL.  
 2. ALL SPECIFICATIONS ARE SUBJECT TO CHANGE WITHOUT NOTICE AT ANY TIME.  
 3. DIMENSIONS ARE IN INCHES [mm].

CAGE CODE 53919

CAD FILE 09/14/18

SCALE N/A

SIZE A

7361



## SMA Female Connector Clamp/Solder Attachment For RG213, RG214, RG8, RG9, RG11, RG225, RG393

### TECHNICAL DATA SHEET

PE4411

#### SMA Female Connector Clamp/Solder Attachment For RG213, RG214, RG8, RG9, RG11, RG225, RG393

##### Configuration

Connector	SMA Female
Connector Specification	MIL-C-39012
Connector Interface Type	RG213, RG214, RG8, RG9, RG11, RG225, RG393
Cable Attachment Method (Shield/Contact)	Clamp/Solder
Body Style	Straight

##### Electrical Specifications

Impedance, Ohms	50
-----------------	----

##### Mechanical Specifications

###### Temperature

Operating Range, deg C	-65 to +165
------------------------	-------------

###### Size

Length, in [mm]	1.5 [38.1]
Width/Dia., in [mm]	0.75 [19.05]
Weight, lbs [g]	0.082 [37.19]

##### Connector

Type	SMA Female
Contact Material and Plating	Gold
Contact Plating Specification	MIL-G-45204
Body Material and Plating	Brass, Nickel
Dielectric Type	Teflon

##### Compliance Certifications (visit [www.Pasternack.com](http://www.Pasternack.com) for current document)

RoHS Compliant	Yes
----------------	-----

Click the following link (or enter part number in "SEARCH" on website) to obtain additional part information including price, inventory and certifications: [SMA Female Connector Clamp/Solder Attachment For RG213, RG214, RG8, RG9, RG11, RG225, RG393 PE4411](#)

The information contained in this document is accurate to the best of our knowledge and representative of the part described herein. It may be necessary to make modifications to the part and/or the documentation of the part, in order to implement improvements. Pasternack reserves the right to make such changes as required. Unless otherwise stated, all specifications are nominal.



SMA Female Connector Clamp/Solder Attachment For  
RG213, RG214, RG8, RG9, RG11, RG225, RG393

TECHNICAL DATA SHEET

PE4411

**Plotted and Other Data**

Notes:

Values at 25 °C, sea level

SMA Female Connector Clamp/Solder Attachment For RG213, RG214, RG8, RG9, RG11, RG225, RG393 from Pasternack Enterprises has same day shipment for domestic and International orders. Our RF, microwave and fiber optic products maintain a 99% availability and are part of the broadest selection in the industry.

Click the following link (or enter part number in "SEARCH" on website) to obtain additional part information including price, inventory and certifications: [SMA Female Connector Clamp/Solder Attachment For RG213, RG214, RG8, RG9, RG11, RG225, RG393 PE4411](http://www.pasternack.com/sma-female-standard-rg213-rg214-rg8-rg9-rg11-rg225-rg393-connector-pe4411-p.aspx)

URL: <http://www.pasternack.com/sma-female-standard-rg213-rg214-rg8-rg9-rg11-rg225-rg393-connector-pe4411-p.aspx>

The information contained in this document is accurate to the best of our knowledge and representative of the part described herein. It may be necessary to make modifications to the part and/or the documentation of the part, in order to implement improvements. Pasternack reserves the right to make such changes as required. Unless otherwise stated, all specifications are nominal.

# PE4411 CAD Drawing

SMA Female Connector Clamp/Solder Attachment For RG213,  
RG214, RG8, RG9, RG11, RG225, RG393

## ASSEMBLY PROCEDURES

1. SLIDE CLAMP NUT (1) & GASKET (2) OVER CABLE. STRIP CABLE AS SHOWN. DO NOT NICK BRAID WHILE CUTTING JACKET. TAPER END OF BRAID TO PERMIT ASSEMBLY OF BRAID CLAMP (3) SLIDE BRAID CLAMP(3) OVER BRAID & SEAT AGAINST CABLE.

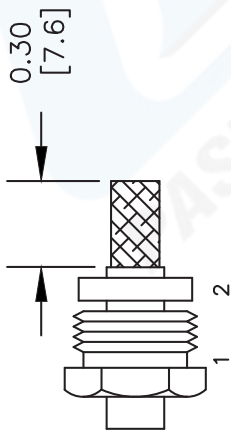

2. FORM BRAID OVER CLAMP NUT (3). TRIM BRAID BACK TO SHOULDER. CUT DIELECTRIC TO DIMENSION SHOWN. DO NOT NICK CENTER CONDUCTOR. SOLDER CONTACT TO CENTER CONDUCTOR. REMOVE EXCESS SOLDER. DO NOT OVER HEAT DIELECTRIC. INSERT CABLE ASSEMBLY INTO BODY & TIGHTEN.

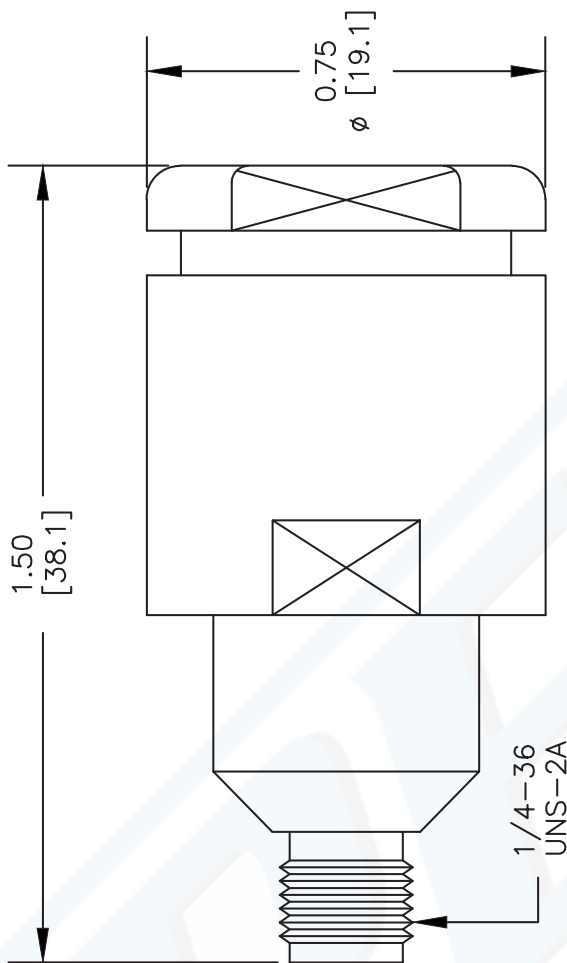
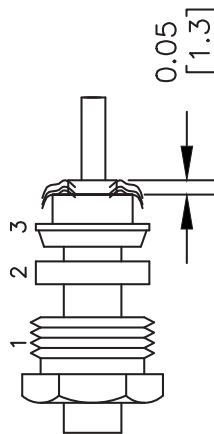

DWG TITLE

**PE4411**

NOTES:  
1. UNLESS OTHERWISE SPECIFIED ALL DIMENSIONS ARE NOMINAL.  
2. ALL SPECIFICATIONS ARE SUBJECT TO CHANGE WITHOUT NOTICE AT ANY TIME.  
3. DIMENSIONS ARE IN INCHES [mm].  
4. FITS MIL-C-17 AND EQUIVALENT CABLES.

REV. -

FSCM NO. 53919

CAD FILE 051402

SCALE N/A

SIZE A

2233

**PE PASTERNAK®**

Pasternack Enterprises, Inc.

P.O. Box 16759 | Irvine | CA | 92623

Phone: (949) 261-1920 | Fax: (949) 261-7451

Website: www.pasternack.com | E-Mail: sales@pasternack.com



## Flexible RG8 Coax Cable Single Shielded with Black PVC (NC) Jacket

### RF Cables Technical Data Sheet

RG8A/U

#### Times Microwave Systems Coax Cable Specification Configuration

- Flexible Cable
- 1 Shield(s)

#### Electrical Specifications

Description	Minimum	Typical	Maximum	Units
Frequency Range	DC		1,000	MHz
Impedance		50		Ohms
Velocity of Propagation		66		%
Nominal Capacitance		30.8 [101.05]		pF/ft [pF/m]

#### Performance by Frequency Band

Description	F1	F2	F3	F4	F5	Units
Frequency	1	10	50	400	700	MHz
Attenuation, Typ	0.2	0.6	1.3	4.1	6.5	dB/100ft
	0.66	1.97	4.27	13.45	21.33	dB/100m

Description	F6	F7	F8	F9	F10	Units
Frequency	900	1,000				MHz
Attenuation, Typ	7.6	8				dB/100ft
	24.93	26.25				dB/100m

#### Mechanical Specifications

Diameter	0.405 in [10.29 mm]
Weight	0.105 lbs/ft [0.16 Kg/m]

#### Construction Specifications

Description	Material and Plating	Diameter
Inner Conductor	Copper, 7 Strands	0.085 in [2.16 mm]

Click the following link (or enter part number in "SEARCH" on website) to obtain additional part information including price, inventory and certifications: [Flexible RG8 Coax Cable Single Shielded with Black PVC \(NC\) Jacket RG8A/U](#)



## Flexible RG8 Coax Cable Single Shielded with Black PVC (NC) Jacket

### RF Cables Technical Data Sheet

RG8A/U

Conductor Type	Stranded	
Dielectric	PE	0.285 in [7.24 mm]
First Shield	Copper Braid	0.318 in [8.08 mm]
Jacket	PVC (NC), Black	0.405 in [10.29 mm]

#### Environmental Specifications

##### Temperature

Operating Range -40 to +80 deg C

**Compliance Certifications** (see [product page](#) for current document)

#### Plotted and Other Data

Notes:

Flexible RG8 Coax Cable Single Shielded with Black PVC (NC) Jacket from Pasternack Enterprises has same day shipment for domestic and International orders. Our RF, microwave and millimeter wave products maintain a 99.4% availability and are part of the broadest selection in the industry.

Click the following link (or enter part number in "SEARCH" on website) to obtain additional part information including price, inventory and certifications: [Flexible RG8 Coax Cable Single Shielded with Black PVC \(NC\) Jacket RG8A/U](#)

URL: <https://www.pasternack.com/flexible-0.405-rg8-52-ohm-coax-cable-pvc-jacket-rg8a-u-p.aspx>

The information contained in this document is accurate to the best of our knowledge and representative of the part described herein. It may be necessary to make modifications to the part and/or the documentation of the part, in order to implement improvements. Pasternack reserves the right to make such changes as required. Unless otherwise stated, all specifications are nominal. Pasternack does not make any representation or warranty regarding the suitability of the part described herein for any particular purpose, and Pasternack does not assume any liability arising out of the use of any part or documentation.

# RG8A/U CAD Drawing

Flexible RG8 Coax Cable Single Shielded with Black PVC (NC) Jacket

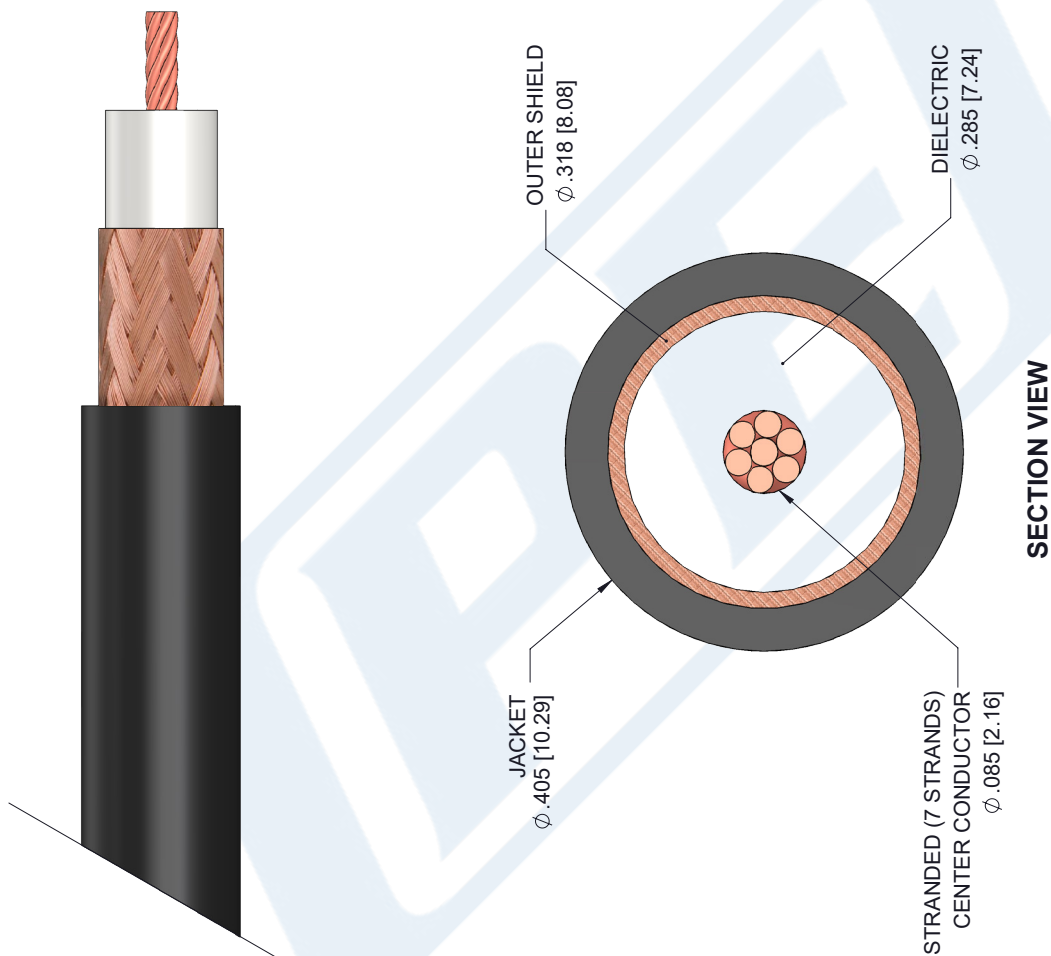

STANDARD TOLERANCES	
.X	±0.2
.XX	±0.01
.XXX	±0.005

\*STANDARD TOLERANCES APPLY ONLY TO DIMENSIONS IN INCHES



Pasternack Enterprises, Inc.  
 P.O. Box 16759 | Irvine | CA | 92623  
**Phone:** (949) 261-1920 | **Fax:** (949) 261-7451  
**Website:** [www.pasternack.com](http://www.pasternack.com) | **E-Mail:** [sales@pasternack.com](mailto:sales@pasternack.com)

DWG TITLE

RG8A/U

NOTES:  
 1. UNLESS OTHERWISE SPECIFIED ALL DIMENSIONS ARE NOMINAL.  
 2. ALL SPECIFICATIONS ARE SUBJECT TO CHANGE WITHOUT NOTICE AT ANY TIME.  
 3. DIMENSIONS ARE IN INCHES [mm].

CAGE CODE 53919

CAD FILE 12/21/18

SCALE N/A

SIZE A

7361