



MMCX Plug Right Angle Connector Crimp/ Solder Attachment for RG178, RG196

RF Connectors Technical Data Sheet

PE4899

Configuration

- MMCX Plug Connector
- BS EN 122340
- 50 Ohms
- Right Angle Body Geometry
- RG178, RG196 Interface Type
- Crimp/Solder Attachment

Features

- Max. Operating Frequency 6 GHz
- Good VSWR of 1.35:1
- Gold Plated Brass Contact
- 30 µm minimum contact plating

Applications

- General Purpose Test
- Custom Cable Assemblies

Description

Pasternack's PE4899 MMCX plug right angle connector with crimp/solder attachment for RG178 and RG196 is part of our full line of RF components available for same-day shipping. Our MMCX plug connector operates up to a maximum frequency of 6 GHz and offers good VSWR of 1.35:1. Its right angle body geometry allows for easier connections in tight spaces.

Our MMCX plug right angle connector PE4899 datasheet specifications and drawing with dimensions are shown below in this PDF. Pasternack's broad catalog of RF, microwave and millimeter wave connectors allows designers to configure and customize their signal connections however they like. Whether the need is to provide an I/O for a board design, or simply create a custom cable assembly configuration, Pasternack has the right connector for the job. Pasternack can also expertly build your custom cable assemblies for you and ship same-day.

Electrical Specifications

Description	Minimum	Typical	Maximum	Units
Frequency Range	DC		6	GHz
VSWR			1.35:1	
Operating Voltage (AC)			170	Vrms

Mechanical Specifications

Size

Length	0.354 in [8.99 mm]
Width/Dia.	0.126 in [3.20 mm]
Height	0.276 in [7.01 mm]
Weight	0.007 lbs [3.18 g]

Click the following link (or enter part number in "SEARCH" on website) to obtain additional part information including price, inventory and certifications: [MMCX Plug Right Angle Connector Crimp/Solder Attachment for RG178, RG196 PE4899](#)



MMCX Plug Right Angle Connector Crimp/
Solder Attachment for RG178, RG196

RF Connectors Technical Data Sheet

PE4899

Material Specifications

Description	Material	Plating
Contact	Brass	Gold 30 µin minimum
Insulation	PTFE	
Body	Brass	Gold 3 µin minimum

Environmental Specifications

Temperature

Operating Range -55 to +155 deg C

Compliance Certifications (see [product page](#) for current document)

Plotted and Other Data

Notes:

MMCX Plug Right Angle Connector Crimp/Solder Attachment for RG178, RG196 from Pasternack Enterprises has same day shipment for domestic and International orders. Our RF, microwave and millimeter wave products maintain a 99% availability and are part of the broadest selection in the industry.

Click the following link (or enter part number in "SEARCH" on website) to obtain additional part information including price, inventory and certifications: [MMCX Plug Right Angle Connector Crimp/Solder Attachment for RG178, RG196 PE4899](#)

URL: <https://www.pasternack.com/mmcx-plug-standard-rg178-rg196-connector-pe4899-p.aspx>

The information contained in this document is accurate to the best of our knowledge and representative of the part described herein. It may be necessary to make modifications to the part and/or the documentation of the part, in order to implement improvements. Pasternack reserves the right to make such changes as required. Unless otherwise stated, all specifications are nominal. Pasternack does not make any representation or warranty regarding the suitability of the part described herein for any particular purpose, and Pasternack does not assume any liability arising out of the use of any part or documentation.

PE4899 CAD Drawing

MMCX Plug Right Angle Connector Crimp/Solder Attachment for RG178, RG196

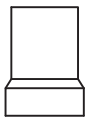

INSERT

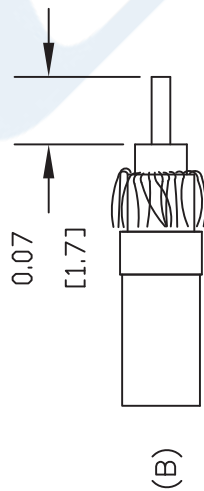
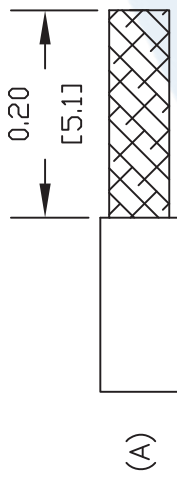

**STRIPPING DIMENSIONS
ASSEMBLY PROCEDURES**

1. STRIP CABLE AS SHOWN IN (A). DO NOT NICK BRAID WHILE CUTTING JACKET.
2. SLIDE INSERT OVER BRAID AND AGAINST JACKET, FORM BRAID OVER INSERT. TRIM BRAID BACK TO SHOULDER. CUT DIELECTRIC AND CENTER CONDUCTOR TO DIMENSION SHOWN IN (B) TIN CENTER CONDUCTOR.
3. INSTALL CABLE INTO BODY OF CONNECTOR AND SOFT SOLDER CENTER CONDUCTOR.
4. CRIMP FERRULE & PRESS CAP DOWN.

CRIMP SIZE REQUIRED

FERRULE: .105" HEX CRIMP TOOL

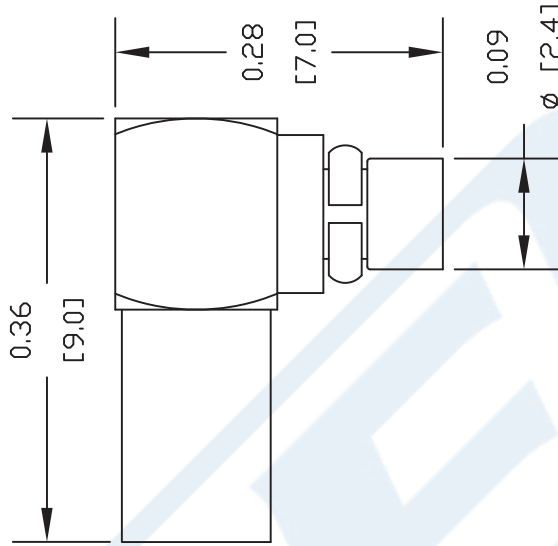

DWG TITLE

PE4899

- NOTES:
1. UNLESS OTHERWISE SPECIFIED ALL DIMENSIONS ARE NOMINAL.
 2. ALL SPECIFICATIONS ARE SUBJECT TO CHANGE WITHOUT NOTICE AT ANY TIME.
 3. DIMENSIONS ARE IN INCHES [mm].
 4. FITS MIL-C-17 AND EQUIVALENT CABLES.

REV. -

FSCM NO. 53919

CAD FILE 061302

SCALE N/A

SIZE A

127



PASTERNAK®
 Pasternack Enterprises, Inc.
 P.O. Box 16759 | Irvine | CA | 92623
 Phone: (949) 261-1920 | Fax: (949) 261-7451
 Website: www.pasternack.com | E-Mail: sales@pasternack.com



SMP Female Connector Solder Attachment for RG178, RG196

RF Connectors Technical Data Sheet

PE44655

Configuration

- SMP Female Connector
- MIL-STD-348
- 50 Ohms
- Straight Body Geometry
- RG178, RG196 Interface Type
- Solder/Solder Attachment

Features

- Max. Operating Frequency 3 GHz
- Excellent VSWR of 1.25:1
- Gold Plated Beryllium Copper Contact
- Contact plating according to MIL-G-45204
- Blind Mate Connector

Applications

- General Purpose Test
- Custom Cable Assemblies

Description

Pasternack's PE44655 SMP female connector with solder/solder attachment for RG178 and RG196 is part of our full line of RF components available for same-day shipping. Our SMP female connector operates up to a maximum frequency of 3 GHz and offers excellent VSWR of 1.25:1. The Pasternack blind mate connector is ideal for applications where direct visual or tactile access to the connection point is not possible, for example, when two circuit boards need to be mated.

Our SMP female connector PE44655 datasheet specifications and drawing with dimensions are shown below in this PDF. Pasternack's broad catalog of RF, microwave and millimeter wave connectors allows designers to configure and customize their signal connections however they like. Whether the need is to provide an I/O for a board design, or simply create a custom cable assembly configuration, Pasternack has the right connector for the job. Pasternack can also expertly build your custom cable assemblies for you and ship same-day.

Electrical Specifications

Description	Minimum	Typical	Maximum	Units
Frequency Range	DC		3	GHz
VSWR			1.25:1	

Mechanical Specifications

Size	
Length	0.25 in [6.35 mm]
Width/Dia.	0.135 in [3.43 mm]
Weight	0.003 lbs [1.36 g]

Click the following link (or enter part number in "SEARCH" on website) to obtain additional part information including price, inventory and certifications: [SMP Female Connector Solder Attachment for RG178, RG196 PE44655](#)



SMP Female Connector Solder Attachment for RG178, RG196

RF Connectors Technical Data Sheet

PE44655

Material Specifications

Description	Material	Plating
Contact	Beryllium Copper	Gold MIL-G-45204
Insulation	PTFE	
Body	Beryllium Copper	Gold MIL-G-45204

Environmental Specifications

Temperature

Operating Range -55 to +125 deg C

Compliance Certifications (see [product page](#) for current document)

Plotted and Other Data

Notes:

SMP Female Connector Solder Attachment for RG178, RG196 from Pasternack Enterprises has same day shipment for domestic and International orders. Our RF, microwave and millimeter wave products maintain a 99% availability and are part of the broadest selection in the industry.

Click the following link (or enter part number in "SEARCH" on website) to obtain additional part information including price, inventory and certifications: [SMP Female Connector Solder Attachment for RG178, RG196 PE44655](#)

URL: <https://www.pasternack.com/smp-female-standard-rg178-rg196-connector-pe44655-p.aspx>

The information contained in this document is accurate to the best of our knowledge and representative of the part described herein. It may be necessary to make modifications to the part and/or the documentation of the part, in order to implement improvements. Pasternack reserves the right to make such changes as required. Unless otherwise stated, all specifications are nominal. Pasternack does not make any representation or warranty regarding the suitability of the part described herein for any particular purpose, and Pasternack does not assume any liability arising out of the use of any part or documentation.

PE44655 CAD Drawing

SMP Female Connector Solder Attachment for RG178, RG196



ASSEMBLY PROCEDURES

1. INSERT HEAT SHRINK TUBE ON CABLE; STRIP CABLE TO DIMENSION SHOWN. DIP END OF CABLE INTO FLUX AND THEN TIN BRAID.

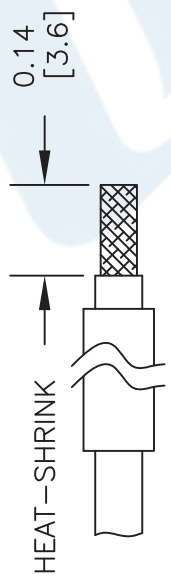

2. AFTER PRE TINNING TRIM TO DIMENSION SHOWN.

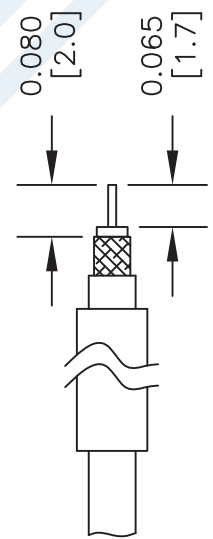

3. SOFT SOLDER CONTACT.

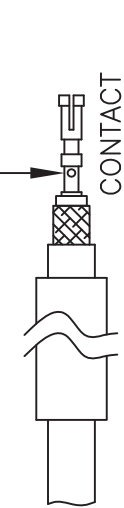

4. INSTALL CABLE INTO BODY AND SOLDER CABLE TO BODY AS SHOWN, SLIDE HEAT-SHRINK TUBE TOWARDS BODY SHOULDER AND SHRINK TO FIT.

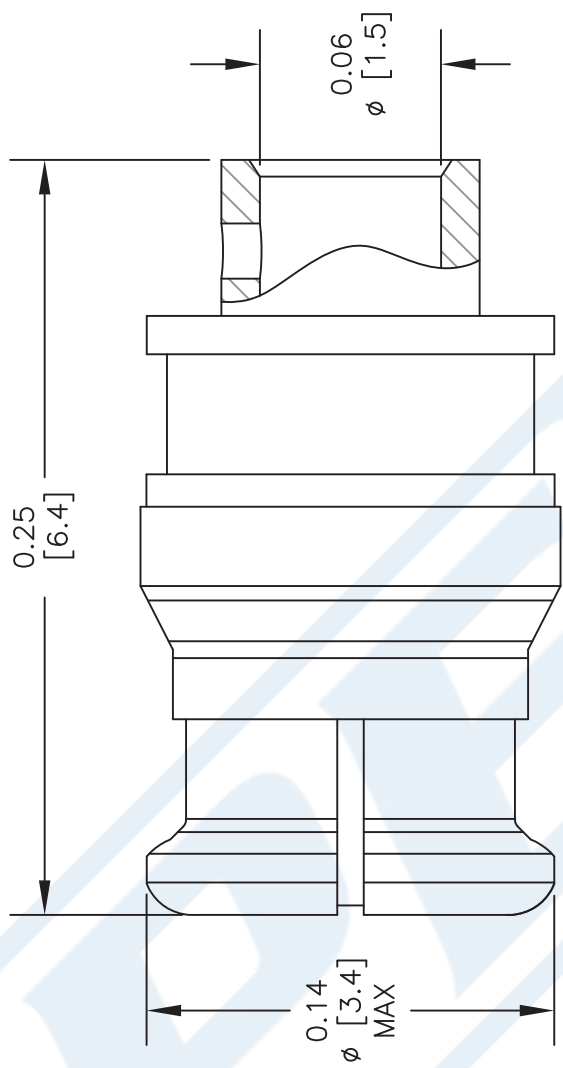
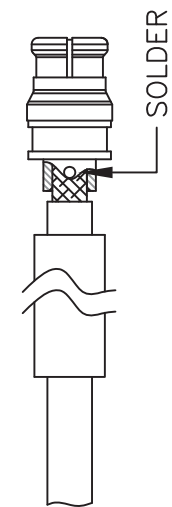

DWG TITLE

PE44655

NOTES:
 1. UNLESS OTHERWISE SPECIFIED ALL DIMENSIONS ARE NOMINAL.
 2. ALL SPECIFICATIONS ARE SUBJECT TO CHANGE WITHOUT NOTICE AT ANY TIME.
 3. DIMENSIONS ARE IN INCHES [mm].
 4. FITS MIL-C-17 AND EQUIVALENT CABLES.

FSCM NO. 53919

CAD FILE 071113

SCALE N/A

SIZE A

2233



Pasternack Enterprises, Inc.
 P.O. Box 16759 | Irvine | CA | 92623
 Phone: (949) 261-1920 | Fax: (949) 261-7451
 Website: www.pasternack.com | E-Mail: sales@pasternack.com

Flexible RG196 Coax Cable Single Shielded with White PTFE Jacket

RF Cables Technical Data Sheet

RG196A/U

Configuration

- Flexible Cable
- 1 Shield(s)

Electrical Specifications

Description	Minimum	Typical	Maximum	Units
Frequency Range	DC		1,000	MHz
Impedance		50		Ohms
Dielectric Withstanding Voltage (AC)			2,000	Vrms
Nominal Capacitance		32 [104.99]		pF/ft [pF/m]

Performance by Frequency Band

Description	F1	F2	F3	F4	F5	Units
Frequency	400					MHz
Attenuation, Typ	33					dB/100ft
	108.27					dB/100m

Mechanical Specifications

Diameter	0.08 in [2.03 mm]
Weight	0.005 lbs/ft [0.01 Kg/m]

Construction Specifications

Description	Material and Plating	Diameter
Inner Conductor	Copper Clad Steel, Silver, 7 Strands	0.011 in [0.28 mm]
Conductor Type	Stranded	
Dielectric	PTFE	0.035 in [0.89 mm]
First Shield	Silver Plated Copper Braid 92.3% coverage	0.054 in [1.37 mm]

Click the following link (or enter part number in "SEARCH" on website) to obtain additional part information including price, inventory and certifications: [Flexible RG196 Coax Cable Single Shielded with White PTFE Jacket RG196A/U](#)

Flexible RG196 Coax Cable Single
Shielded with White PTFE Jacket

RF Cables Technical Data Sheet

RG196A/U

Jacket	PTFE, White	0.08 in [2.03 mm]
--------	-------------	-------------------

Environmental Specifications

Temperature

Operating Range -55 to +200 deg C

Compliance Certifications (see [product page](#) for current document)

Plotted and Other Data

Notes:

Flexible RG196 Coax Cable Single Shielded with White PTFE Jacket from Pasternack Enterprises has same day shipment for domestic and International orders. Our RF, microwave and millimeter wave products maintain a 99.4% availability and are part of the broadest selection in the industry.

Click the following link (or enter part number in "SEARCH" on website) to obtain additional part information including price, inventory and certifications: [Flexible RG196 Coax Cable Single Shielded with White PTFE Jacket RG196A/U](#)

URL: <https://www.pasternack.com/flexible-0.080-rg196-50-ohm-coax-cable-ptfe-jacket-rg196a-u-p.aspx>

The information contained in this document is accurate to the best of our knowledge and representative of the part described herein. It may be necessary to make modifications to the part and/or the documentation of the part, in order to implement improvements. Pasternack reserves the right to make such changes as required. Unless otherwise stated, all specifications are nominal. Pasternack does not make any representation or warranty regarding the suitability of the part described herein for any particular purpose, and Pasternack does not assume any liability arising out of the use of any part or documentation.

RG196A/U CAD Drawing

Flexible RG196 Coax Cable Single Shielded with White PTFE Jacket



NOTES:
1. UNLESS OTHERWISE SPECIFIED ALL DIMENSIONS ARE NOMINAL.
2. ALL SPECIFICATIONS ARE SUBJECT TO CHANGE WITHOUT NOTICE AT ANY TIME.
3. DIMENSIONS ARE IN INCHES [mm].

DWG TITLE
RG196A/U

FSCM NO. 53919

CAD FILE 111716

SCALE N/A

SIZE A

41742

(PE) PASTERNAK®
THE ENGINEER'S RF SOURCE
Pasternack Enterprises, Inc.
P.O. Box 16759 | Irvine | CA | 92623

Phone: (949) 261-1920 | Fax: (949) 261-7451

Website: www.pasternack.com | E-Mail: sales@pasternack.com