



TNC Male Right Angle Connector Crimp/Solder Attachment For RG8X, PE-C240, 0.240 inch

TECHNICAL DATA SHEET

PE44635

TNC Male Right Angle Connector Crimp/Solder Attachment For RG8X, PE-C240, 0.240 inch

**Configuration**

Connector	TNC Male
Connector Interface Type	RG8X,PE-C240,0.240 inch
Cable Attachment Method (Shield/Contact)	Crimp/Solder
Body Style	Right Angle

**Electrical Specifications**

Impedance, Ohms	50
-----------------	----

**Mechanical Specifications**

**Size**

Length, in [mm]	1.103 [28.02]
Width/Dia., in [mm]	0.59 [15]
Height, in [mm]	1.06 [26.92]
Weight, lbs [g]	0.042 [19.05]

**Connector**

Type	TNC Male
Contact Material and Plating	Brass, Gold
Coupling Nut Material and Plating	Brass, Nickel
Body Material and Plating	Brass, Nickel
Dielectric Type	Teflon

**Compliance Certifications** (visit [www.Pasternack.com](http://www.Pasternack.com) for current document)

RoHS Compliant	Yes
----------------	-----

**Plotted and Other Data**

Notes: Values at 25 °C, sea level

URL: <http://www.pasternack.com/tnc-male-standard-rg8x-pe-c240-0.240-connector-pe44635-p.aspx>

TNC Male Right Angle Connector Crimp/Solder Attachment For RG8X, PE-C240, 0.240 inch from Pasternack Enterprises has same day shipment for domestic and International orders. We maintain 99% availability of the industry's broadest selection of RF, microwave and fiber optic products.

The information contained in this document is accurate to the best of our knowledge and representative of the part described herein. It may be necessary to make modifications to the part and/or the documentation of the part, in order to implement improvements. Pasternack reserves the right to make such changes as required. Unless otherwise stated, all specifications are nominal.

# PE44635 CAD Drawing

TNC Male Right Angle Connector Crimp/Solder  
Attachment For RG8X, PE-C240, 0.240 inch

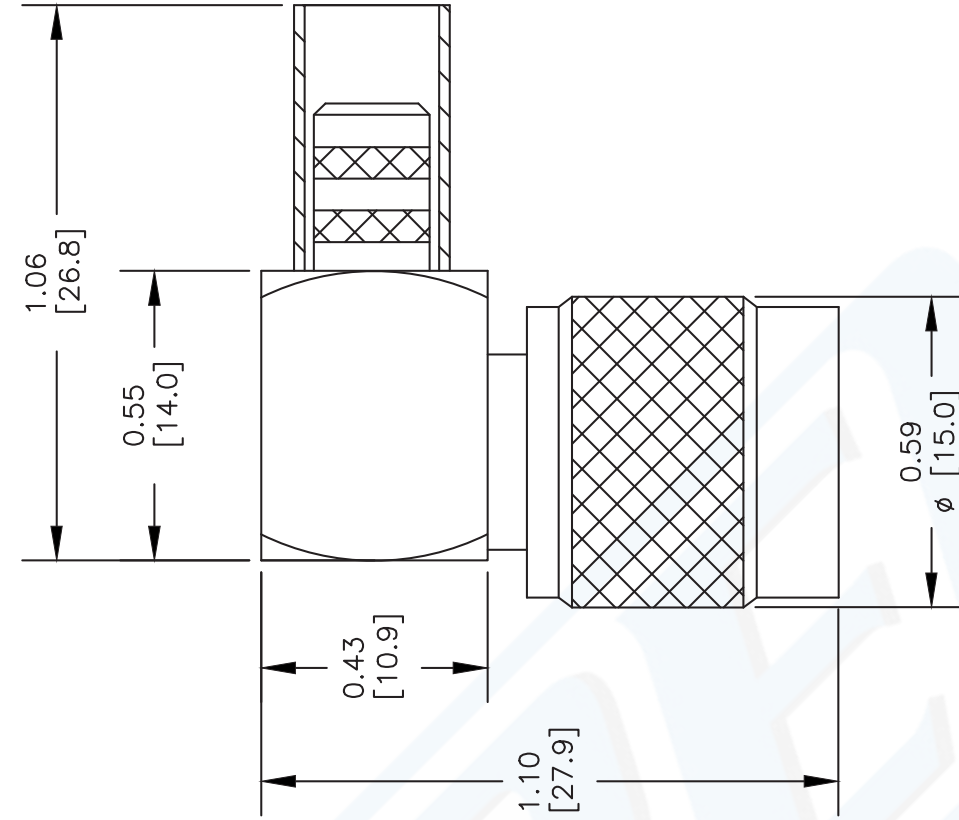

## ASSEMBLY PROCEDURES

1. STRIP CABLE AS SHOWN. SLIDE FERRULE OVER CABLE.

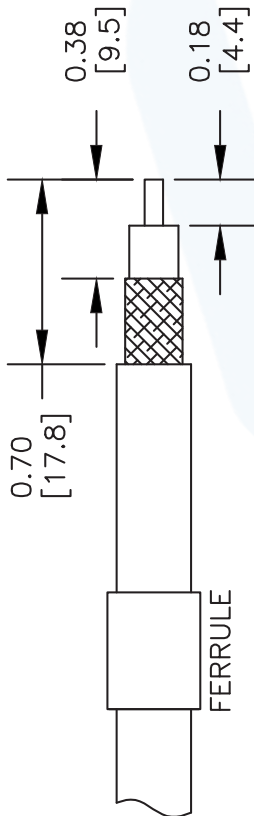

2. FLAIR BRAID AND INSERT THE STRIPPED CABLE INTO BODY AND POSITION THE CENTER CONDUCTOR IN THE SLOT OF THE CENTER PIN.



3. SLIDE FERRULE OVER BRAID UP TO THE CONNECTOR BODY AND CRIMP AS CLOSE TO THE CONNECTOR BODY AS POSSIBLE USING A .255" HEX CRIMP TOOL.



4. SOLDER THE CENTER CONDUCTOR OF THE CABLE TO THE CENTER PIN. TIGHTEN DOWN THE CAP INTO THE REAR APERTURE OF THE BO

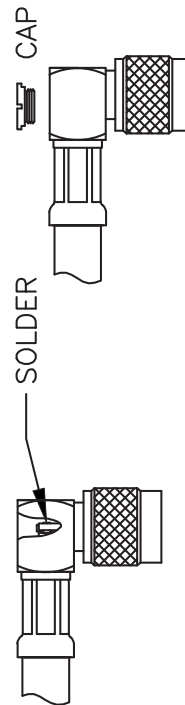

DWG TITLE

**PE44635**

NOTES:  
1. UNLESS OTHERWISE SPECIFIED ALL DIMENSIONS ARE NOMINAL.  
2. ALL SPECIFICATIONS ARE SUBJECT TO CHANGE WITHOUT NOTICE AT ANY TIME.  
3. DIMENSIONS ARE IN INCHES [mm].  
4. FITS MIL-C-17 AND EQUIVALENT CABLES.

REV. B

FSCM NO. 53919

CAD FILE 012012-B

SCALE N/A

SIZE A

2233



Pasternack Enterprises, Inc.  
P.O. Box 16759 | Irvine | CA | 92623

Phone: (949) 261-1920 | Fax: (949) 261-7451

Website: [www.pasternack.com](http://www.pasternack.com) | E-Mail: [sales@pasternack.com](mailto:sales@pasternack.com)



RP-TNC Jack Connector Crimp/Non-Solder Contact Attachment for LMR-240, LMR-240-DB, LMR-240-UF, LMR-240-FR, RG8X, PE-C240

## RF Connectors Technical Data Sheet



**EZ-240-TF-RP-X**

### Times Microwave Systems Connector Specification

#### Configuration

- TNC Jack Reverse Polarity Connector
- 50 Ohms
- Straight Body Geometry
- Connector Interface Types: LMR-240, LMR-240-DB, LMR-240-UF, LMR-240-FR, RG8X, PE-C240

#### Features

- Max. Operating Frequency 6 GHz
- Good VSWR of 1.3:1
- Tri-Metal Plated Brass Contact
- 80  $\mu$ m minimum contact plating
- Reverse Polarity

#### Applications

- General Purpose Test
- Custom Cable Assemblies

#### Description

EZ-240-TF-RP-X RP TNC jack coaxial connector has an interface type of TNC jack LMR-240, LMR-240-DB, LMR-240-UF, LMR-240-FR, RG8X, and PE-C240 and a 50 Ohms impedance. Pasternack's TNC jack connector uses crimp/non-solder contact as an attachment method. Our jack TNC coaxial connector provides a maximum frequency of 6 GHz.

The Pasternack TNC jack coaxial connector has a PTFE dielectric type and a VSWR of 1.3:1. Pasternack's TNC coaxial connector has a brass body with tri-metal plating. Our EZ-240-TF-RP-X TNC connector uses a tri-metal plated brass contact. Additional RF connector specs and dimensions for this component can be found on its PDF specification datasheet and CAD drawings above.

The radio frequency connector is made from brass material and has a contact life of 500 cycles or more. Our high-quality EZ-240-TF-RP-X features an 80  $\mu$ m minimum body plating specification. The Pasternack EZ-240-TF-RP-X TNC connector operates at a temperature range of -40 to 125 deg C.

This Pasternack reverse polarity jack TNC connector will ship the same business day as purchased. Our TNC jack connector is part of over 40,000 RF, microwave, and millimeter wave components in stock for local, domestic, and international shipment. For further information on similar products, our expert technical support and trained sales team can get you the ideal RF connector as per your requirements.

#### Electrical Specifications

Description	Minimum	Typical	Maximum	Units
Frequency Range	DC		6	GHz
VSWR			1.3:1	
Insertion Loss			0.24	dB
Impedance		50		Ohms
Dielectric Withstanding Voltage (DC)			1,500	Vdc
Insulation Resistance	5,000			MOhms

Click the following link (or enter part number in "SEARCH" on website) to obtain additional part information including price, inventory and certifications: [RP-TNC Jack Connector Crimp/Non-Solder Contact Attachment for LMR-240, LMR-240-DB, LMR-240-UF, LMR-240-FR, RG8X, PE-C240 EZ-240-TF-RP-X](#)



RP-TNC Jack Connector Crimp/Non-Solder Contact Attachment for LMR-240, LMR-240-DB, LMR-240-UF, LMR-240-FR, RG8X, PE-C240

## RF Connectors Technical Data Sheet

Electrical Specification Notes:  
Insertion Loss is  $0.1 \cdot \sqrt{f(\text{GHz})}$  dB

#### Mechanical Specifications

##### Size

Length	1.20 in [30.48 mm]
Width	0.43 in [10.92 mm]
Height	0.43 in [10.92 mm]
Weight	0.10 lbs [45.36 g]
Mating Cycles	500 Cycles
Cable Retention Force	250 lbs 113.4 kg

#### Material Specifications

Description	Material	Plating
Contact	Brass	Tri-Metal 80 $\mu$ m minimum
Insulation	PTFE	
Body	Brass	Tri-Metal 80 $\mu$ m minimum
Crimp Sleeve	Brass	Tri-Metal 80 $\mu$ m minimum

#### Environmental Specifications

##### Temperature

Operating Range	-40 to +125 deg C
Shock	MIL-STD 202G, Meth.213, Cond.G
Vibration	MIL-STD 202G, Meth.204, Cond.B
Thermal Shock	MIL-STD 202G, Meth.107, Cond.B

**Compliance Certifications** (see [product page](#) for current document)

#### Plotted and Other Data

Notes:

Click the following link (or enter part number in "SEARCH" on website) to obtain additional part information including price, inventory and certifications: [RP-TNC Jack Connector Crimp/Non-Solder Contact Attachment for LMR-240, LMR-240-DB, LMR-240-UF, LMR-240-FR, RG8X, PE-C240 EZ-240-TF-RP-X](#)



RP-TNC Jack Connector Crimp/Non-Solder Contact Attachment for LMR-240, LMR-240-DB, LMR-240-UF, LMR-240-FR, RG8X, PE-C240

## RF Connectors Technical Data Sheet

RP-TNC Jack Connector Crimp/Non-Solder Contact Attachment for LMR-240, LMR-240-DB, LMR-240-UF, LMR-240-FR, RG8X, PE-C240 from Pasternack Enterprises has same day shipment for domestic and International orders. Our RF, microwave and millimeter wave products maintain a 99.4% availability and are part of the broadest selection in the industry.

Click the following link (or enter part number in "SEARCH" on website) to obtain additional part information including price, inventory and certifications: [RP-TNC Jack Connector Crimp/Non-Solder Contact Attachment for LMR-240, LMR-240-DB, LMR-240-UF, LMR-240-FR, RG8X, PE-C240 EZ-240-TF-RP-X](#)

URL: <https://www.pasternack.com/tnc-jack-reverse-polarity-lmr-240-connector-ez-240-tf-rp-x.p.aspx>

The information contained in this document is accurate to the best of our knowledge and representative of the part described herein. It may be necessary to make modifications to the part and/or the documentation of the part, in order to implement improvements. Pasternack reserves the right to make such changes as required. Unless otherwise stated, all specifications are nominal. Pasternack does not make any representation or warranty regarding the suitability of the part described herein for any particular purpose, and Pasternack does not assume any liability arising out of the use of any part or documentation.

**EZ-240-TF-RP-X CAD Drawing**  
 RP-TNC Jack Connector Crimp/Non-Solder Contact Attachment for LMR-240, LMR-240-DB, LMR-240-UF, LMR-240-FR, RG8X, PE-C240

ZONE	REV	DESCRIPTION	DATE	CHANGED BY	APPROVED
	A	INITIAL RELEASE	5/19/2023	KDANG	AGANWANI

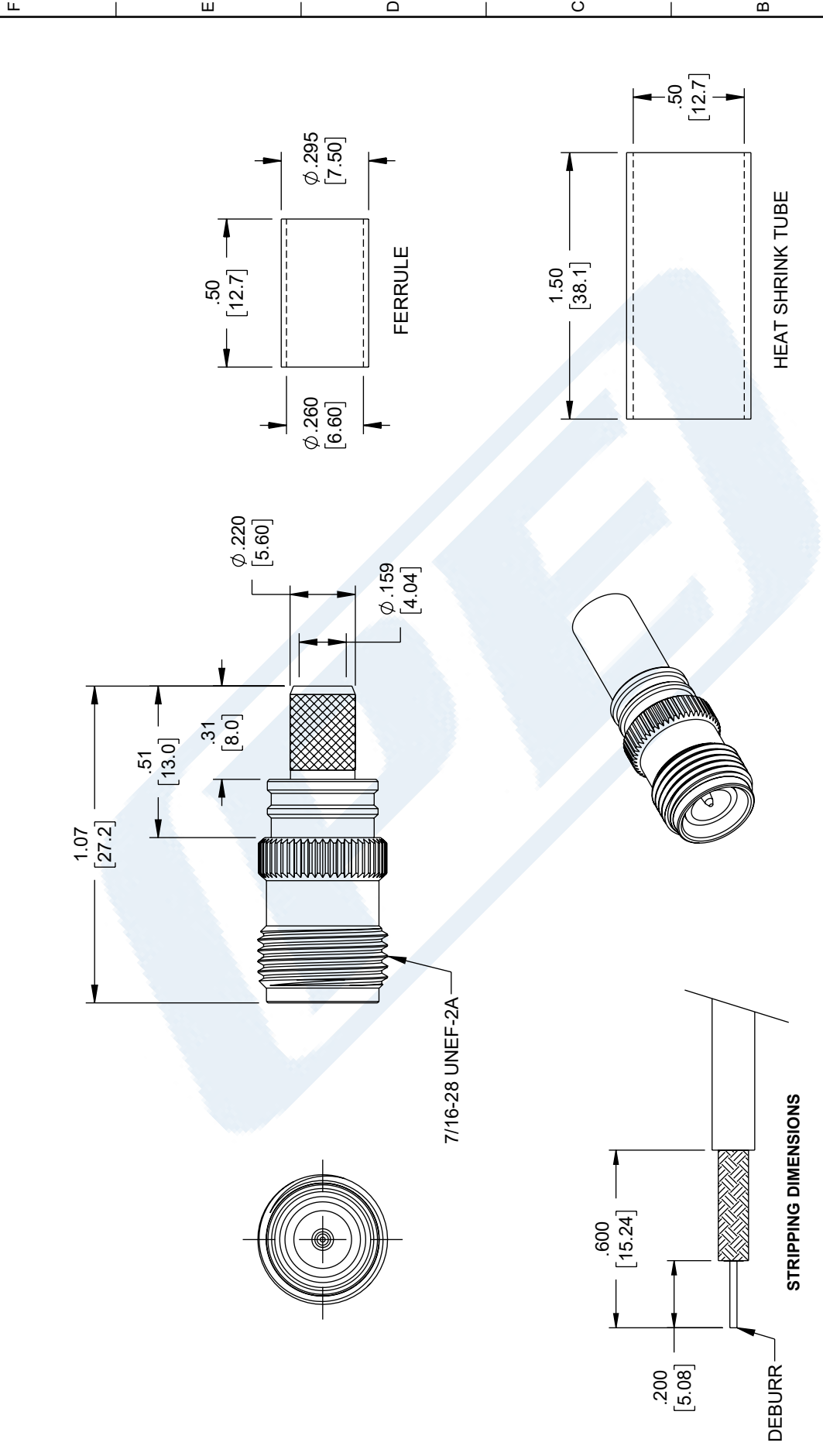

**PASTERNAK**  
 an INFINITI® brand

Website: [www.Pasternack.com](http://www.Pasternack.com)  
 Phone: 1.866.727.8376 | 1.949.261.1920

INTERPRET ALL DIMENSIONS AND TOLERANCES PER ASME Y14.5  
 SCALE: NONE  
 SHEET: 1 OF 1

DESCRIPTION:  
 RP-TNC Jack Connector Crimp/Non-Solder Contact Attachment for LMR-240

SIZE	A	CAGE CODE	53919	DRAWN BY	KDANG	ITEM NO.	EZ-240-TF-RP-X
REV	A						

UNLESS OTHERWISE SPECIFIED LEADING DIMENSIONS ARE INCHES DIMENSIONS IN [ ] ARE MILLIMETERS  
 TOLERANCES:  
 .X = ±.2 [5] FRACTIONS  
 .XX = ±.02 [5] ±.1/32  
 .XXX = ±.005 [13] ANGLES ± 1°  
 CABLE LENGTH TOLERANCES:  
 ≤12 [305] = +1 [25] / -0  
 >12 [305] ≤ 60 [1524] = +2 [51] / -0  
 >60 [1524] ≤ 120 [3048] = +4 [102] / -0  
 >120 [3048] ≤ 300 [7620] = +6 [152] / -0  
 >300 [7620] = +5% / -0  
 ALL DIMENSIONS ARE FOR REFERENCE ONLY AND SUBJECT TO CHANGE WITHOUT NOTICE

**NOTES:**  
 1. CABLE ATTACHMENT:  
     • OUTER: CRIMP.  
 2. CRIMP SIZE REQUIRED:  
     • FERRULE: .255 [6.48] HEX. CRIMP TOOL.

THE INFORMATION CONTAINED IN THIS DRAWING IS THE SOLE PROPERTY OF INFINITE ELECTRONICS, INC. ANY REPRODUCTION IN PART OR WHOLE WITHOUT THE WRITTEN PERMISSION OF INFINITE ELECTRONICS, INC. IS PROHIBITED. THESE COMMODITIES, TECHNOLOGY OR SOFTWARE WERE EXPORTED FROM THE UNITED STATES IN ACCORDANCE WITH THE EXPORT ADMINISTRATION REGULATIONS. DIVERSION CONTRARY TO U.S. LAW PROHIBITED.

## LMR®-240-UF UltraFlex Communications Coax

### Ideal for...

- Jumper Assemblies in Wireless Communications Systems
- Short Antenna Feeder runs (e.g. WLL, GPS, LMR, Mobile Antennas)
- Any application that requires periodic/repeated flexing



• **LMR® - UltraFlex** has a stranded center conductor and rubber outer jacket designed for multiple bending/flexing cycles. It is used for both indoor and outdoor applications.

• **Flexibility** and bendability are hallmarks of the LMR-240-UF cable design. The flexible outer conductor enables the tightest bend radius available for any cable of similar size and performance.

• **Low Loss** is another hallmark feature of LMR-240-UF. Size for size LMR has the lowest loss of any flexible cable and comparable loss to semirigid hard-line cables.

• **RF Shielding** is 50 dB greater than typical single shielded coax (40 dB). The multi-ply bonded foil outer conductor is rated conservatively at > 90 dB (i.e. >180 dB between two adjacent cables).

• **Weatherability:** LMR-240-UF cables are designed for outdoor exposure and have a life expectancy in excess of 10 years.

• **Connectors:** A wide variety of connectors are available for LMR-240-UF cable, including all common interface types, reverse polarity, and solder-on center pins. Most LMR connectors employ crimp outer attachment using standard hex crimp sizes.

• **Cable Assemblies:** All LMR-240-UF cable types are available as pre-terminated cable assemblies. Refer to the section on FlexTech for further details.

Construction Specifications			
Description	Material	In.	(mm)
Inner Conductor	Stranded BC	0.056	(1.42)
Dielectric	Foam Polyethylene	0.150	(3.81)
Outer Conductor	Aluminum Tape	0.155	(3.94)
Overall Braid	Tinned Copper	0.178	(4.52)
Jacket	Black Thermoplastic Elastomer	0.240	(6.10)

Mechanical Specifications			
Performance Property	Units	US	(metric)
Bend Radius: installation	in. (mm)	0.75	(19.1)
Bend Radius: repeated	in. (mm)	2.5	(63.5)
Bending Moment	ft-lb (N-m)	0.125	(0.17)
Weight	lb/ft (kg/m)	0.034	(0.05)
Tensile Strength	lb (kg)	80	(36.3)
Flat Plate Crush	lb/in. (kg/mm)	13	(0.23)

Environmental Specifications		
Performance Property	°F	°C
Installation Temperature Range	-40/+185	-40/+85
Storage Temperature Range	-94/+185	-70/+85
Operating Temperature Range	-40/+185	-40/+85

Electrical Specifications			
Performance Property	Units	US	(metric)
Velocity of Propagation	%	84	
Dielectric Constant	NA	1.42	
Time Delay	nS/ft (nS/m)	1.21	(3.97)
Impedance	ohms	50	
Capacitance	pF/ft (pF/m)	24.2	(79.4)
Inductance	uH/ft (uH/m)	0.060	(0.20)
Shielding Effectiveness	dB	>90	
DC Resistance			
Inner Conductor	ohms/1000ft (/km)	4.28	(14.1)
Outer Conductor	ohms/1000ft (/km)	3.89	(12.8)
Voltage Withstand	Volts DC	1500	
Jacket Spark	Volts RMS	5000	
Peak Power	kW	5.6	

Part Description				
Part Number	Application	Jacket	Color	Stock Code
LMR-240-UF	Indoor/Outdoor	TPE	Black	54041

Attenuation vs. Frequency (typical)



Frequency (MHz)	30	50	150	220	450	900	1500	1800	2000	2500	5800
Attenuation dB/100 ft	1.6	2.1	3.6	4.4	6.3	9.1	11.8	13.0	13.8	15.5	24.4
Attenuation dB/100 m	5.3	6.8	11.9	14.4	20.8	29.8	38.9	42.8	45.2	50.9	80.1
Avg. Power kW	1.24	0.96	0.55	0.45	0.31	0.22	0.17	0.15	0.14	0.13	0.08

Calculate Attenuation = (0.290501) • √FMHz + (0.000396) • FMHz (interactive calculator available at [http://www.timesmicrowave.com/cable\\_calculators](http://www.timesmicrowave.com/cable_calculators))  
 Attenuation: VSWR=1.0; Ambient = +25°C (77°F) Power: VSWR=1.0; Ambient = +40°C; Inner Conductor = 100°C (212°F);  
 Sea Level; dry air; atmospheric pressure; no solar loading

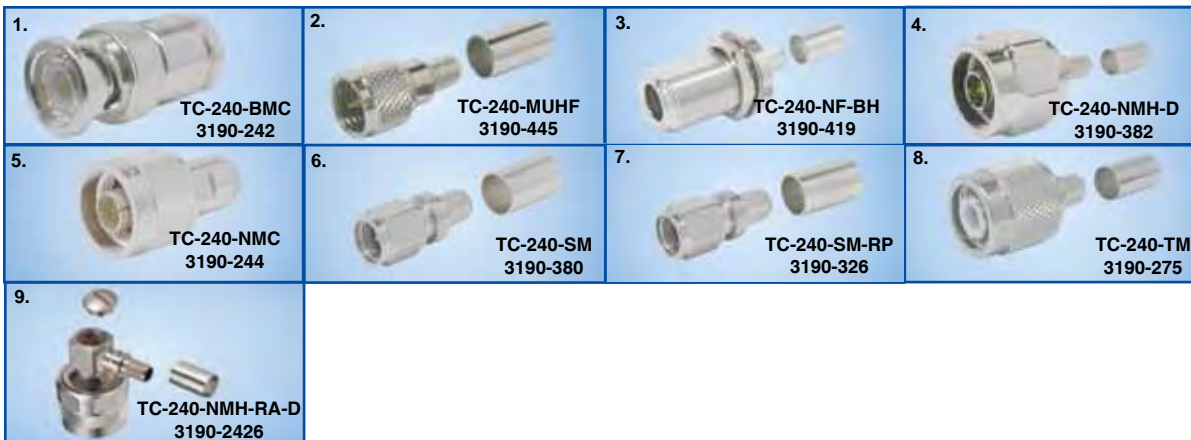

**Connectors**

Interface	Description	Part Number	Stock Code	VSWR** Freq. (GHz)	Coupling Nut	Inner Contact Attach	Outer Contact Attach	Finish* /Pin	Length in (mm)	Width in (mm)	Weight lb (g)
1. BNC Male	Straight Plug	TC-240-BMC	3190-242	<1.25:1 (2.5)	Knurl	Solder	Clamp	S/G	1.7 (43)	0.56(14.2)	0.040 (18.1)
2. Mini-UHF	Straight Plug	TC-240-MUHF	3190-445	<1.25:1 (2.5)	Knurl	Solder	Crimp	N/G	1.1 (28)	0.45(11.4)	0.014 (6.4)
3. N Female	Bulkhead Jack	TC-240-NF-BH	3190-419	<1.25:1 (2.5)	NA	Solder	Crimp	A/G	1.7 (44)	0.88(22.2)	0.115 (52.2)
4. N Male	Straight Plug	TC-240-NMH-D	3190-382	<1.25:1 (2.5)	Hex	Solder	Crimp	N/S	1.5 (38)	0.75(19.1)	0.086 (39.0)
5. N Male	Straight Plug	TC-240-NMC	3190-244	<1.25:1 (2.5)	Knurl	Solder	Clamp	S/G	1.5 (38)	0.75(19.1)	0.082 (37.2)
6. SMA Male	Straight Plug	TC-240-SM	3190-380	<1.25:1 (10)	Hex	Solder	Crimp	SS/G	1.0 (25)	0.32(8.1)	0.016 (7.3)
7. SMA Male	Reverse Polarity	TC-240-SM-RP	3190-326	<1.25:1 (2.5)	Hex	Solder	Crimp	SS/G	1.0 (25)	0.32(8.1)	0.016 (7.3)
8. TNC Male	Straight Plug	TC-240-TM	3190-275	<1.25:1 (2.5)	Knurl	Solder	Crimp	N/S	1.7 (43)	0.59(15.0)	0.043 (19.5)
9. N Male	Right Angle	TC-240-NMH-RA-D	3190-2426	<1.35:1 (6)	Hex/Knurl	Solder	Crimp	A/G	1.2 (32.4)	1.22 (31.0)	0.091 (41.7)

\* Finish metals: N=Nickel, S=Silver, G=Gold, SS=Stainless Steel, A=Alballoy \*\*VSWR spec based on 3 foot cable with a connector pair

**Hardware Accessories**

Type	Part Number	Stock Code	Description
Ground Kit	GK-S240TT	GK-S240TT	Standard Ground Kit (each)

**Install Tools**

Type	Part Number	Stock Code	Description
Crimp Tool	CT-240/200/195/100	3190-667	Crimp tool for LMR-100, 195, 200 and 240 connectors
Cutting Tool	CCT-01	3190-1544	Cable end flush cut tool
Replacement Blade	RB-01	3190-1609	Replacement blade for cutting tool

