

NOTICE OF PROPRIETARY RIGHTS THIS DOCUMENT CONTAINS CONFIDENTIAL TECHNICAL DATA, INCLUDING TRADE SECRETS, PROPRIETARY TO TIMES MICROWAVE SYSTEMS. DISCLOSURE OF THIS DATA IS EXPRESSLY CONDITIONED UPON YOUR ASSENT THAT ITS USE IS LIMITED TO USE WITHIN YOUR COMPANY ONLY. ANY OTHER USE IS STRICTLY PROHIBITED WITHOUT THE PRIOR WRITTEN CONSENT OF TIMES MICROWAVE SYSTEMS.

SYM	REVISION DESCRIPTION	DFTM	DATE	APPD	DATE
A	RELEASED FOR PRODUCTION	K.A.M.	5/20/11	J.D.B.	6/9/11



Reference standard IEC60169-16

I. Electric Performance

Nominal Impedance(Ω):	50
Frequency Range:	DC-6GHz
VSWR:	≤ 1.35
Insert Loss:	≤ 0.10 (0-3G)
Insulation resistance ($M\Omega$)	> 5000
Proof voltage (V)	2500
Conductor resistance ($m\Omega$)	outer conductor < 0.4 inner conductor < 0.8

II. Mechanical Performance

Whorl pull	500N
Nut torque	5N.m
Tensile force(cable-connect)	400N
Torsion(cable-connect)	2N.m

III. Material and plating :

Component	Material	Plating
inner conductor	Beryllium copper	Au $> 1.27\mu m$
outer conductor	Brass	Copper-tin-zinc $> 2\mu m$
insulator	PTFE	
nut	Brass	Copper-tin-zinc $> 2\mu m$

IV. Environment

Temp.range	-55 $^{\circ}C$ ~+155 $^{\circ}C$
Weather standard	IEC 60068 55 / 155/ 56
Thermal shock	US MIL-STD 202,Meth.107,Cond.B
Vibration	US MIL-STD 202,Meth.204,Cond.B
Shock	US MIL-STD 202,Meth.213,Cond.I
Waterproof standard	IP67
ROHS compliant	

MATERIAL:	UNLESS OTHERWISE SPECIFIED		DFTM: K. A. M.	TIMES MICROWAVE SYSTEMS			
	ALL DIMENSIONS ARE IN mm		DATE: 5/20/11				
USED ON:			CHKD: J. D. B.	CONNECTOR, NM FOR LMR-400 (EZ-400-NMC-2-D)			
			DATE: 6/9/11				
			APPD: J. D. B.				
SCALE: ~	DWG. SIZE: A	DO NOT SCALE DRAWING	CODE IDENT: 68999	DATE: 6/9/11	SHEET: 1 of 1	SD3190-2640	REV: A



TNC Female Connector Solder Attachment for LMR-400, LMR-400-DB, LMR-400-UF, PE-B400, PE-B405, PE-C400

RF Connectors Technical Data Sheet

PE45639

Configuration

- TNC Female Connector
- 50 Ohms
- Straight Body Geometry
- Connector Interface Types: LMR-400, LMR-400-DB, LMR-400-UF, PE-B400, PE-B405, PE-C400

Features

- Max. Operating Frequency 6 GHz
- Excellent VSWR of 1.2:1
- Gold Plated Brass Contact

Applications

- General Purpose Test
- Custom Cable Assemblies

Description

Pasternack's PE45639 TNC female connector with solder attachment for LMR-400, LMR-400-DB, LMR-400-UF, PE-B400, PE-B405 and PE-C400 is part of our full line of RF components available for same-day shipping. Our TNC female connector operates up to a maximum frequency of 6 GHz and offers excellent VSWR of 1.2:1.

Our TNC female connector PE45639 datasheet specifications and drawing with dimensions are shown below in this PDF. Pasternack's broad catalog of RF, microwave and millimeter wave connectors allows designers to configure and customize their signal connections however they like. Whether the need is to provide an I/O for a board design, or simply create a custom cable assembly configuration, Pasternack has the right connector for the job. Pasternack can also expertly build your custom cable assemblies for you and ship same-day.

Electrical Specifications

Description	Minimum	Typical	Maximum	Units
Frequency Range	DC		6	GHz
VSWR			1.2:1	
Insertion Loss			0.2	dB
Operating Voltage (DC)			500	Vdc
Dielectric Withstanding Voltage (AC)			1,500	Vrms
Dielectric Withstanding Voltage (DC)			1,500	Vdc

Mechanical Specifications

Size

Length	1.11 in [28.19 mm]
Width/Dia.	0.56 in [14.22 mm]
Weight	0.5 lbs [226.8 g]
Mating Cycles	500 Cycles

Click the following link (or enter part number in "SEARCH" on website) to obtain additional part information including price, inventory and certifications: [TNC Female Connector Solder Attachment for LMR-400, LMR-400-DB, LMR-400-UF, PE-B400, PE-B405, PE-C400 PE45639](#)



TNC Female Connector Solder Attachment for LMR-400, LMR-400-DB, LMR-400-UF, PE-B400, PE-B405, PE-C400

RF Connectors
Technical Data Sheet

PE45639

Material Specifications

Description	Material	Plating
Contact	Brass	Gold
Insulation	PTFE	
Body	Brass	Nickel
Crimp Sleeve	Brass	Nickel

Environmental Specifications

Temperature

Operating Range	-55 to +85 deg C
Humidity	MIL-Std. 202 Method 106
Vibration	MIL-Std. 202 Method 204 (Test Condition D)
Altitude	MIL-Std. 202 Method 105 (Test Condition C)
Temperature Cycle	MIL-Std. 202 Method 102 (Test Condition D)
Salt Spray	MIL-Std. 202 Method 101 (Test Condition B)

Compliance Certifications (see [product page](#) for current document)

Plotted and Other Data

Notes:

TNC Female Connector Solder Attachment for LMR-400, LMR-400-DB, LMR-400-UF, PE-B400, PE-B405, PE-C400 from Pasternack Enterprises has same day shipment for domestic and International orders. Our RF, microwave and millimeter wave products maintain a 99.4% availability and are part of the broadest selection in the industry.

Click the following link (or enter part number in "SEARCH" on website) to obtain additional part information including price, inventory and certifications: [TNC Female Connector Solder Attachment for LMR-400, LMR-400-DB, LMR-400-UF, PE-B400, PE-B405, PE-C400 PE45639](#)

URL: <https://www.pasternack.com/tnc-female-lmr-400-lmr-400-db-connector-pe45639-p.aspx>

The information contained in this document is accurate to the best of our knowledge and representative of the part described herein. It may be necessary to make modifications to the part and/or the documentation of the part, in order to implement improvements. Pasternack reserves the right to make such changes as required. Unless otherwise stated, all specifications are nominal. Pasternack does not make any representation or warranty regarding the suitability of the part described herein for any particular purpose, and Pasternack does not assume any liability arising out of the use of any part or documentation.

PE45639 CAD Drawing

TNC Female Connector Solder Attachment for LMR-400, LMR-400-DB, LMR-400-UF, PE-B400, PE-B405, PE-C400

REVISIONS			
REV.	DESCRIPTION	DATE	APPROVED
A	INITIAL RELEASE	9/11/2020	S. ELLIS

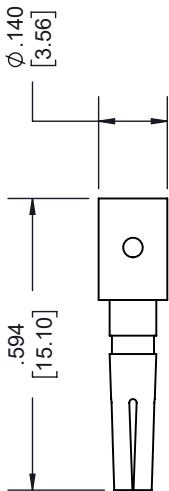
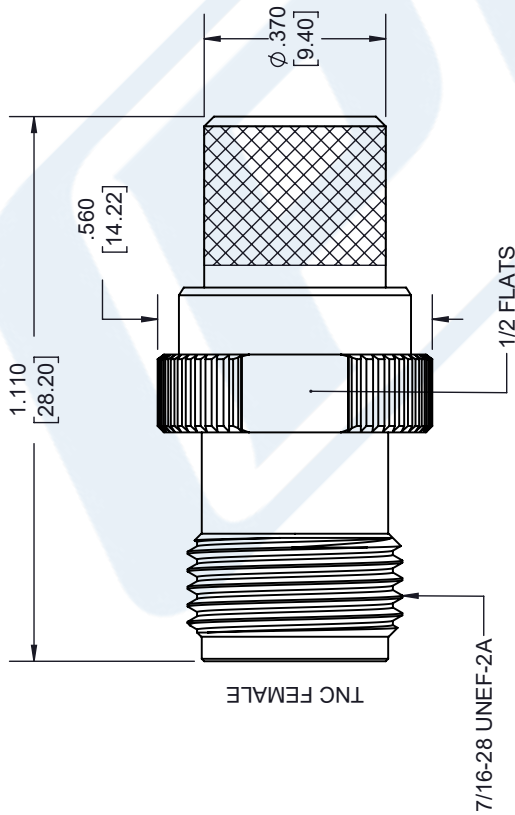
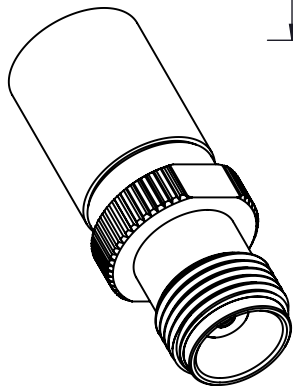

CONTACT

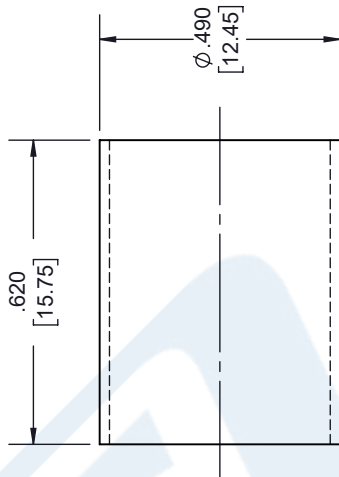

FERRULE

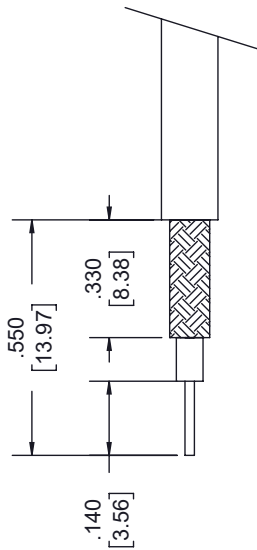

STRIPPING DIMENSIONS

- NOTES:
- CABLE ATTACHMENT:
 - OUTER: CRIMP.
 - INNER: SOLDER.
 - CRIMP SIZE REQUIRED:
 - FERRULE: .429 [10.90] HEX. CRIMP TOOL.
 - CONTACT: SOLDER.

UNLESS OTHERWISE SPECIFIED LEADING DIMENSIONS ARE INCHES DIMENSIONS IN [] ARE MILLIMETERS

TOLERANCES:

.X = ±.2 [5.08] | FRACTIONS ± 1/32
 .XX = ±.02 [.51] | ANGLES ± 1°
 .XXX = ±.005 [.13]

CABLE LENGTH (L), TOLERANCES:
 L ≤ 12 [305] = +1 [25] / -0
 12 [305] < L ≤ 60 [1524] = +2 [51] / -0
 60 [1524] < L ≤ 120 [3048] = +4 [102] / -0
 120 [3048] < L ≤ 300 [7620] = +6 [152] / -0
 300 [7620] < L = +5% / -0

ALL DIMENSIONS SHOWN ARE FOR REFERENCE ONLY.

<p>PASTERNACK an INFINITE® brand</p> <p>Pasternack Enterprises, Inc. P. O. Box 16759, Irvine, CA 92623. Phone: 1.949.261.1920 1.866.727.8376 Fax: 1.949.261.7451 Website: www.pasternack.com E-mail: sales@pasternack.com</p>		<p>THIRD-ANGLE PROJECTION</p> <p>THE INFORMATION AND DESIGN IN THIS DOCUMENT IS THE PROPERTY OF PASTERNACK CORPORATION ALL RIGHTS RESERVED.</p> <p>SHEET 1 OF 1</p> <p>SCALE N/A</p>
<p>SIZE A</p> <p>CAGE CODE 53919</p> <p>DRAWN BY K.DANG</p> <p>ITEM NO. PE45639</p>	<p>REV A</p>	

THESE COMMODITIES, TECHNOLOGY OR SOFTWARE WERE EXPORTED FROM THE UNITED STATES IN ACCORDANCE WITH THE EXPORT ADMINISTRATION REGULATIONS. DIVERSION CONTRARY TO U.S. LAW PROHIBITED.

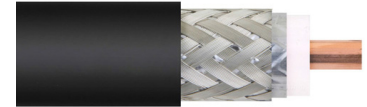

Low Loss Flexible LMR-400 Outdoor Rated Coax Cable Double Shielded with Black PE Jacket

RF Cables Technical Data Sheet

Times Microwave Systems Coax Cable Specification Configuration

- Low Loss, Outdoor Flexible Cable
- 2 Shield(s)

Features

- Flexible Low Loss Communications Coax
- Replacement for Air Dielectric type RG8 cable
- Double Shields provides RF Shielding in excess of 90 db
- Low Loss size for size compared to standard flexible cable

Description

Flexible Low Loss Communications Coax Replacement for Air Dielectric type RG8 cable Double Shields provides RF Shielding in excess of 90 db Low Loss size for size compared to standard flexible cable

Electrical Specifications

Description	Minimum	Typical	Maximum	Units
Frequency Range	DC		6	GHz
Impedance		50		Ohms
Velocity of Propagation		85		%
Time Delay		1.2 [3.94]		ns/ft [ns/m]
Shielding Effectiveness	90			dB
Dielectric Withstanding Voltage (DC)			2,500	Vdc
Jacket Spark			8,000	Vrms
Inner Conductor DC Resistance			1.39	Ohms/1000ft
Outer Conductor DC Resistance			1.65	Ohms/1000ft
Nominal Capacitance		23.9 [78.41]		pF/ft [pF/m]
Nominal Inductance		0.06 [0.2]		uH/ft [uH/m]
Input Power (Peak)			16	kWatts

Click the following link (or enter part number in "SEARCH" on website) to obtain additional part information including price, inventory and certifications: [Low Loss Flexible LMR-400 Outdoor Rated Coax Cable Double Shielded with Black PE Jacket LMR-400](#)

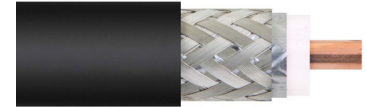

Low Loss Flexible LMR-400 Outdoor Rated Coax Cable Double Shielded with Black PE Jacket

RF Cables Technical Data Sheet

Performance by Frequency Band

Description	F1	F2	F3	F4	F5	Units
Frequency	50	150	220	450	900	MHz
Attenuation, Typ	0.9	1.5	1.9	2.7	3.9	dB/100ft
	2.95	4.92	6.23	8.86	12.8	dB/100m
Input Power (CW), Max	2,570	1,470	1,200	830	580	Watts

Description	F6	F7	F8	F9	F10	Units
Frequency	1.5	1.8	2	2.5	5.8	GHz
Attenuation, Typ	5.1	5.7	6	6.8	10.8	dB/100ft
	16.73	18.7	19.69	22.31	35.43	dB/100m
Input Power (CW), Max	440	400	370	330	210	Watts

Mechanical Specifications

Diameter	0.405 in [10.29 mm]
Weight	0.067 lbs/ft [0.1 kg/m]
Min. Bend Radius (Installation)	1 in [25.4 mm]
Min. Bend Radius (Repeated)	4 in [101.6 mm]
Bending Moment	0.5 lbs-ft [0.68 N-m]
Tensile Strength	160 lbs [72.57 kg]
Flat Plate Crush	40 lbs/in [0.71 kg/mm]

Construction Specifications

Description	Material and Plating	Diameter
Inner Conductor	Copper Clad Aluminum, 1 Strand	0.108 in [2.74 mm]
Conductor Type	Solid	
Dielectric	PE (F)	0.285 in [7.24 mm]
First Shield	Aluminum Tape	0.29 in [7.37 mm]
Second Shield	Tinned Copper Braid	0.32 in [8.13 mm]

Click the following link (or enter part number in "SEARCH" on website) to obtain additional part information including price, inventory and certifications: [Low Loss Flexible LMR-400 Outdoor Rated Coax Cable Double Shielded with Black PE Jacket LMR-400](#)



Low Loss Flexible LMR-400 Outdoor Rated Coax Cable Double Shielded with Black PE Jacket

RF Cables Technical Data Sheet

Jacket	PE, Black	0.405 in [10.29 mm]
--------	-----------	---------------------

Environmental Specifications

Temperature

Operating Range

-40 to 85 deg C

Storage Range

-70 to 85 deg C

Compliance Certifications (see [product page](#) for current document)

Plotted and Other Data

Notes:

Low Loss Flexible LMR-400 Outdoor Rated Coax Cable Double Shielded with Black PE Jacket from Pasternack Enterprises has same day shipment for domestic and International orders. Our RF, microwave and millimeter wave products maintain a 99.4% availability and are part of the broadest selection in the industry.

Click the following link (or enter part number in "SEARCH" on website) to obtain additional part information including price, inventory and certifications: [Low Loss Flexible LMR-400 Outdoor Rated Coax Cable Double Shielded with Black PE Jacket LMR-400](#)

URL: <https://www.pasternack.com/50-ohm-low-loss-flexible-lmr400-pe-jacket-double-shielded-black-lmr-400-p.aspx>

The information contained in this document is accurate to the best of our knowledge and representative of the part described herein. It may be necessary to make modifications to the part and/or the documentation of the part, in order to implement improvements. Pasternack reserves the right to make such changes as required. Unless otherwise stated, all specifications are nominal. Pasternack does not make any representation or warranty regarding the suitability of the part described herein for any particular purpose, and Pasternack does not assume any liability arising out of the use of any part or documentation.

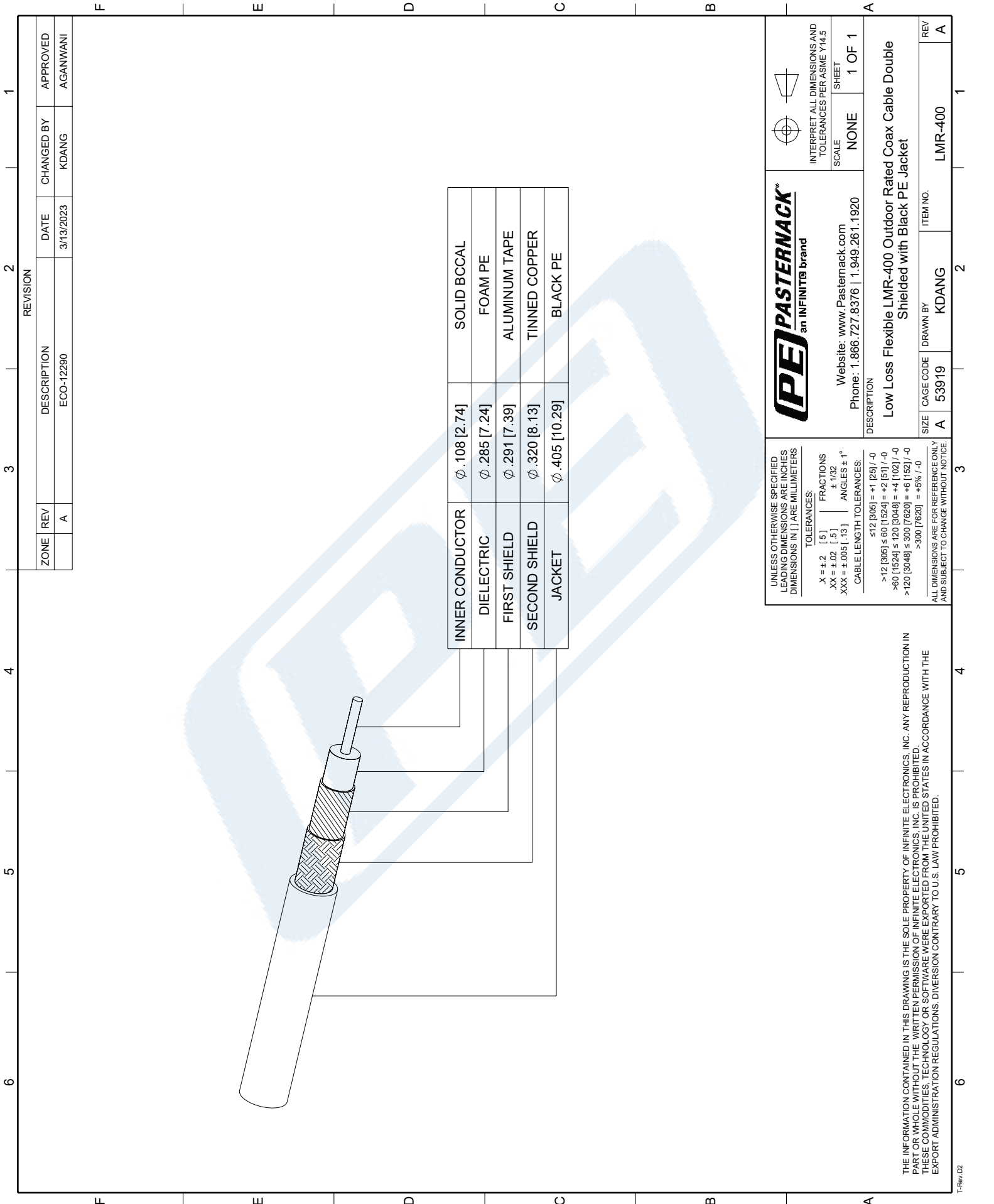

INNER CONDUCTOR	Ø .108 [2.74]	SOLID BCCAL
DIELECTRIC	Ø .285 [7.24]	FOAM PE
FIRST SHIELD	Ø .291 [7.39]	ALUMINUM TAPE
SECOND SHIELD	Ø .320 [8.13]	TINNED COPPER
JACKET	Ø .405 [10.29]	BLACK PE

REVISION			
ZONE	REV	DESCRIPTION	DATE
	A	ECO-12290	3/13/2023
		CHANGED BY	AGANWANI
		KDANG	

(PE) PASTERNAK®
an INFINITIB brand

Website: www.Pasternack.com
Phone: 1.866.727.8376 | 1.949.261.1920

DESCRIPTION
Low Loss Flexible LMR-400 Outdoor Rated Coax Cable Double Shielded with Black PE Jacket

SIZE: A CAGE CODE: 53919 DRAWN BY: KDANG ITEM NO.: LMR-400

INTERPRET ALL DIMENSIONS AND TOLERANCES PER ASME Y14.5

SCALE: NONE SHEET: 1 OF 1

UNLESS OTHERWISE SPECIFIED LEADING DIMENSIONS ARE INCHES DIMENSIONS IN [] ARE MILLIMETERS

TOLERANCES:
 X = ±.2 [5] FRACTIONS ± 1/32
 .XX = ±.02 [.5] ANGLES ± 1°
 .XXX = ±.005 [.13]

CABLE LENGTH TOLERANCES:
 ≤12 [305] = +1 [25] / -0
 >12 [305] ≤ 60 [1524] = +2 [51] / -0
 >60 [1524] ≤ 120 [3048] = +4 [102] / -0
 >120 [3048] ≤ 300 [7620] = +6 [152] / -0
 >300 [7620] = +6% / -0

ALL DIMENSIONS ARE FOR REFERENCE ONLY AND SUBJECT TO CHANGE WITHOUT NOTICE.

THE INFORMATION CONTAINED IN THIS DRAWING IS THE SOLE PROPERTY OF INFINITE ELECTRONICS, INC. ANY REPRODUCTION IN PART OR WHOLE WITHOUT THE WRITTEN PERMISSION OF INFINITE ELECTRONICS, INC. IS PROHIBITED. THESE COMMODITIES, TECHNOLOGY OR SOFTWARE WERE EXPORTED FROM THE UNITED STATES IN ACCORDANCE WITH THE EXPORT ADMINISTRATION REGULATIONS. DIVERSION CONTRARY TO U.S. LAW PROHIBITED.