



SMA Male Right Angle Connector Clamp/Solder Attachment for RG58, RG55, RG142, RG223, RG303, RG400, LMR-195, PE-C195

RF Connectors
Technical Data Sheet

PE45048

Configuration

- SMA Male Connector
- MIL-STD-348
- 50 Ohms
- Right Angle Body Geometry
- Connector Interface Types: RG58, RG55, RG142, RG223, RG303, RG400, LMR-195, PE-C195
- 5/16 inch Hex

Features

- Max. Operating Frequency 12.44 GHz
- Gold over Nickel Plated Brass Contact
- Contact plating according to MIL-G-45204

Applications

- General Purpose Test
- Custom Cable Assemblies

Description

Pasternack's PE45048 SMA male right angle connector with clamp/solder attachment for RG58, RG55, RG142, RG223, RG303, RG400, LMR-195 and PE-C195 is part of our full line of RF components available for same-day shipping. Our SMA male connector operates up to a maximum frequency of 12.44 GHz. Its right angle body geometry allows for easier connections in tight spaces.

Our SMA male right angle connector PE45048 datasheet specifications and drawing with dimensions are shown below in this PDF. Pasternack's broad catalog of RF, microwave and millimeter wave connectors allows designers to configure and customize their signal connections however they like. Whether the need is to provide an I/O for a board design, or simply create a custom cable assembly configuration, Pasternack has the right connector for the job. Pasternack can also expertly build your custom cable assemblies for you and ship same-day.

Electrical Specifications

Description	Minimum	Typical	Maximum	Units
Frequency Range	DC		12.44	GHz
Operating Voltage (DC)			335	Vdc
Dielectric Withstanding Voltage (AC)			1,000	Vrms
Insulation Resistance	5,000			MOhms

Mechanical Specifications

Size	
Length	0.74 in [18.8 mm]
Width/Dia.	0.312 in [7.92 mm]
Height	0.69 in [17.53 mm]
Weight	0.015 lbs [6.8 g]

Click the following link (or enter part number in "SEARCH" on website) to obtain additional part information including price, inventory and certifications: [SMA Male Right Angle Connector Clamp/Solder Attachment for RG58, RG55, RG142, RG223, RG303, RG400, LMR-195, PE-C195 PE45048](#)



SMA Male Right Angle Connector Clamp/Solder Attachment for RG58, RG55, RG142, RG223, RG303, RG400, LMR-195, PE-C195

RF Connectors Technical Data Sheet

PE45048

Material Specifications

Description	Material	Plating
Contact	Brass	Gold over Nickel MIL-G-45204
Insulation	PTFE	
Body	Brass	Nickel QQ-N-290
Coupling Nut	Brass	Nickel QQ-N-290

Environmental Specifications

Temperature

Operating Range

-65 to +165 deg C

Compliance Certifications (see [product page](#) for current document)

Plotted and Other Data

Notes:

SMA Male Right Angle Connector Clamp/Solder Attachment for RG58, RG55, RG142, RG223, RG303, RG400, LMR-195, PE-C195 from Pasternack Enterprises has same day shipment for domestic and International orders. Our RF, microwave and millimeter wave products maintain a 99.4% availability and are part of the broadest selection in the industry.

Click the following link (or enter part number in "SEARCH" on website) to obtain additional part information including price, inventory and certifications: [SMA Male Right Angle Connector Clamp/Solder Attachment for RG58, RG55, RG142, RG223, RG303, RG400, LMR-195, PE-C195 PE45048](#)

URL: <https://www.pasternack.com/sma-male-rg58-rg55-rg223-rg303-rg400-lmr-195-connector-pe45048-p.aspx>

The information contained in this document is accurate to the best of our knowledge and representative of the part described herein. It may be necessary to make modifications to the part and/or the documentation of the part, in order to implement improvements. Pasternack reserves the right to make such changes as required. Unless otherwise stated, all specifications are nominal. Pasternack does not make any representation or warranty regarding the suitability of the part described herein for any particular purpose, and Pasternack does not assume any liability arising out of the use of any part or documentation.

PE45048 CAD Drawing

SMA Male Right Angle Connector Clamp/Solder Attachment for RG58, RG55, RG142, RG223, RG303, RG400, LMR-195, PE-C195

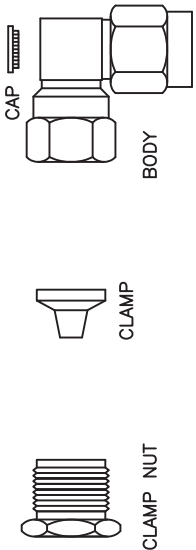

ASSEMBLY PROCEDURES

1. SLIDE NUT ONTO CABLE AS SHOWN. CUT CABLE SQUARE.

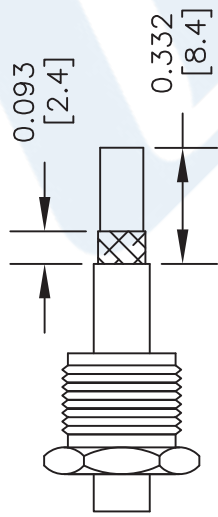

2. SLIDE CLAMP OVER DIELECTRIC AND UNDER BRAID UNTIL JACKET STOPS AGAINST SHOULDER. TWO SLITS IN THE JACKET 180° APART.

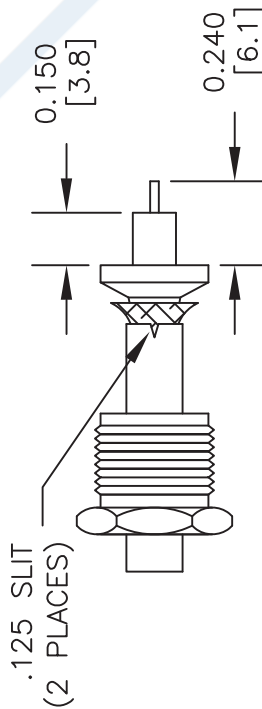

3. SLIDE ASSEMBLY INTO REAR OF BODY, WITH CENTER CONDUCTOR STARTING INTO SLOT OF CONTACT.

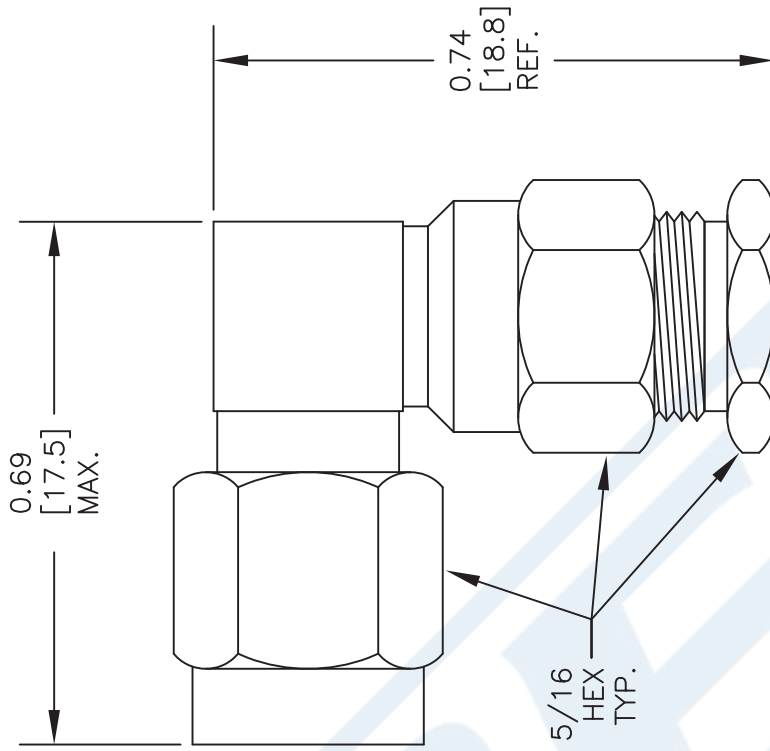
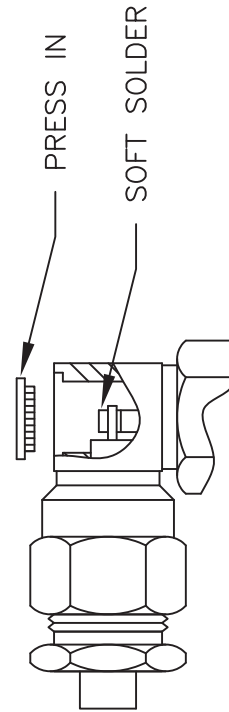

DWG TITLE

PE45048

NOTES:
 1. UNLESS OTHERWISE SPECIFIED ALL DIMENSIONS ARE NOMINAL.
 2. ALL SPECIFICATIONS ARE SUBJECT TO CHANGE WITHOUT NOTICE AT ANY TIME.
 3. DIMENSIONS ARE IN INCHES [mm].
 4. FITS MIL-C-17 AND EQUIVALENT CABLES.

FSCM NO. 53919

CAD FILE 062615

SCALE N/A

SIZE A

2233

PE PASTERNAK
 THE ENGINEER'S RF SOURCE

Pasternack Enterprises, Inc.
 P.O. Box 16759 | Irvine | CA | 92623
 Phone: (949) 261-1920 | Fax: (949) 261-7451
 Website: www.pasternack.com | E-Mail: sales@pasternack.com



SMA Male Right Angle Connector Clamp/Solder Attachment for RG58, RG55, RG142, RG223, RG303, RG400, LMR-195, PE-C195

RF Connectors
Technical Data Sheet

PE45048

Configuration

- SMA Male Connector
- MIL-STD-348
- 50 Ohms
- Right Angle Body Geometry
- Connector Interface Types: RG58, RG55, RG142, RG223, RG303, RG400, LMR-195, PE-C195
- 5/16 inch Hex

Features

- Max. Operating Frequency 12.44 GHz
- Gold over Nickel Plated Brass Contact
- Contact plating according to MIL-G-45204

Applications

- General Purpose Test
- Custom Cable Assemblies

Description

Pasternack's PE45048 SMA male right angle connector with clamp/solder attachment for RG58, RG55, RG142, RG223, RG303, RG400, LMR-195 and PE-C195 is part of our full line of RF components available for same-day shipping. Our SMA male connector operates up to a maximum frequency of 12.44 GHz. Its right angle body geometry allows for easier connections in tight spaces.

Our SMA male right angle connector PE45048 datasheet specifications and drawing with dimensions are shown below in this PDF. Pasternack's broad catalog of RF, microwave and millimeter wave connectors allows designers to configure and customize their signal connections however they like. Whether the need is to provide an I/O for a board design, or simply create a custom cable assembly configuration, Pasternack has the right connector for the job. Pasternack can also expertly build your custom cable assemblies for you and ship same-day.

Electrical Specifications

Description	Minimum	Typical	Maximum	Units
Frequency Range	DC		12.44	GHz
Operating Voltage (DC)			335	Vdc
Dielectric Withstanding Voltage (AC)			1,000	Vrms
Insulation Resistance	5,000			MOhms

Mechanical Specifications

Size	
Length	0.74 in [18.8 mm]
Width/Dia.	0.312 in [7.92 mm]
Height	0.69 in [17.53 mm]
Weight	0.015 lbs [6.8 g]

Click the following link (or enter part number in "SEARCH" on website) to obtain additional part information including price, inventory and certifications: [SMA Male Right Angle Connector Clamp/Solder Attachment for RG58, RG55, RG142, RG223, RG303, RG400, LMR-195, PE-C195 PE45048](#)



SMA Male Right Angle Connector Clamp/Solder Attachment for RG58, RG55, RG142, RG223, RG303, RG400, LMR-195, PE-C195

RF Connectors
 Technical Data Sheet

PE45048

Material Specifications

Description	Material	Plating
Contact	Brass	Gold over Nickel MIL-G-45204
Insulation	PTFE	
Body	Brass	Nickel QQ-N-290
Coupling Nut	Brass	Nickel QQ-N-290

Environmental Specifications

Temperature

Operating Range

-65 to +165 deg C

Compliance Certifications (see [product page](#) for current document)

Plotted and Other Data

Notes:

SMA Male Right Angle Connector Clamp/Solder Attachment for RG58, RG55, RG142, RG223, RG303, RG400, LMR-195, PE-C195 from Pasternack Enterprises has same day shipment for domestic and International orders. Our RF, microwave and millimeter wave products maintain a 99.4% availability and are part of the broadest selection in the industry.

Click the following link (or enter part number in "SEARCH" on website) to obtain additional part information including price, inventory and certifications: [SMA Male Right Angle Connector Clamp/Solder Attachment for RG58, RG55, RG142, RG223, RG303, RG400, LMR-195, PE-C195 PE45048](#)

URL: <https://www.pasternack.com/sma-male-rg58-rg55-rg223-rg303-rg400-lmr-195-connector-pe45048-p.aspx>

The information contained in this document is accurate to the best of our knowledge and representative of the part described herein. It may be necessary to make modifications to the part and/or the documentation of the part, in order to implement improvements. Pasternack reserves the right to make such changes as required. Unless otherwise stated, all specifications are nominal. Pasternack does not make any representation or warranty regarding the suitability of the part described herein for any particular purpose, and Pasternack does not assume any liability arising out of the use of any part or documentation.

PE45048 CAD Drawing

SMA Male Right Angle Connector Clamp/Solder Attachment for RG58, RG55, RG142, RG223, RG303, RG400, LMR-195, PE-C195



ASSEMBLY PROCEDURES

1. SLIDE NUT ONTO CABLE AS SHOWN. CUT CABLE SQUARE.

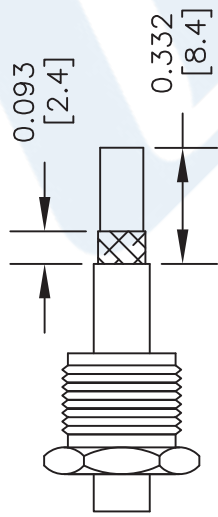

2. SLIDE CLAMP OVER DIELECTRIC AND UNDER BRAID UNTIL JACKET STOPS AGAINST SHOULDER. TWO SLITS IN THE JACKET 180° APART.

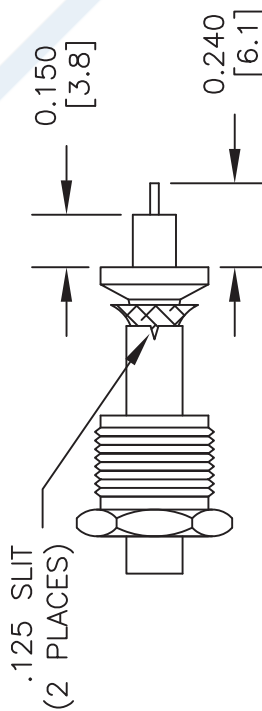

3. SLIDE ASSEMBLY INTO REAR OF BODY, WITH CENTER CONDUCTOR STARTING INTO SLOT OF CONTACT.

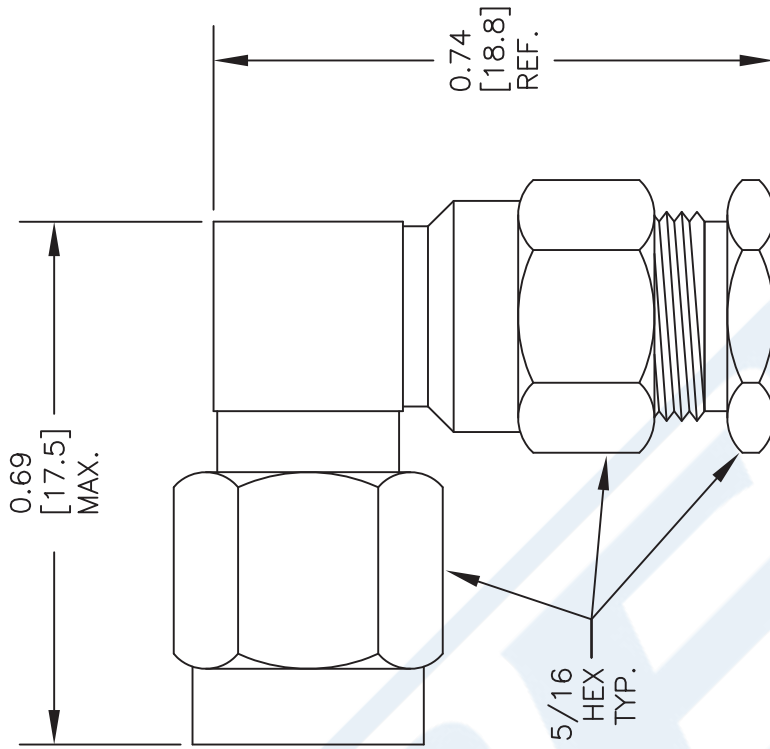
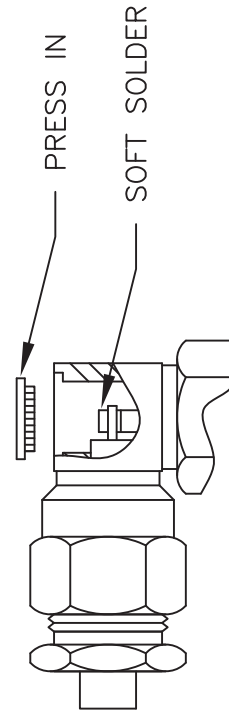

DWG TITLE

PE45048

NOTES:
 1. UNLESS OTHERWISE SPECIFIED ALL DIMENSIONS ARE NOMINAL.
 2. ALL SPECIFICATIONS ARE SUBJECT TO CHANGE WITHOUT NOTICE AT ANY TIME.
 3. DIMENSIONS ARE IN INCHES [mm].
 4. FITS MIL-C-17 AND EQUIVALENT CABLES.

FSCM NO. 53919

CAD FILE 062615

SCALE N/A

SIZE A

2233

PE PASTERNAK
 THE ENGINEER'S RF SOURCE

Pasternack Enterprises, Inc.
 P.O. Box 16759 | Irvine | CA | 92623
 Phone: (949) 261-1920 | Fax: (949) 261-7451
 Website: www.pasternack.com | E-Mail: sales@pasternack.com



Low Loss Flexible PE-P195 Coax Cable Triple Shielded with Tan FEP Jacket

RF Cables Technical Data Sheet

PE-P195

Configuration

- Low Loss Flexible Cable
- 3 Shield(s)

Electrical Specifications

Description	Minimum	Typical	Maximum	Units
Frequency Range	DC		22	GHz
Impedance		50		Ohms
Velocity of Propagation		70		%
Operating Voltage (AC)			1,900	Vrms
Dielectric Withstanding Voltage (AC)			5,000	Vrms
Nominal Capacitance		29 [95.14]		pF/ft [pF/m]

Performance by Frequency Band

Description	F1	F2	F3	F4	F5	Units
Frequency	0.1	0.5	1	5	10	GHz
Attenuation, Typ	3.9	8.8	12.5	31.5	45	dB/100ft
	12.8	28.87	41.01	103.35	147.64	dB/100m

Description	F6	F7	F8	F9	F10	Units
Frequency	15	18	20	22		GHz
Attenuation, Typ	58	65	69	73		dB/100ft
	190.29	213.25	226.38	239.5		dB/100m

Mechanical Specifications

Diameter	0.195 in [4.95 mm]
Weight	0.038 lbs/ft [0.06 Kg/m]
Min. Bend Radius (Repeated)	1 in [25.4 mm]

Click the following link (or enter part number in "SEARCH" on website) to obtain additional part information including price, inventory and certifications: [Low Loss Flexible PE-P195 Coax Cable Triple Shielded with Tan FEP Jacket PE-P195](#)



Low Loss Flexible PE-P195 Coax Cable Triple Shielded with Tan FEP Jacket

RF Cables Technical Data Sheet

PE-P195

Construction Specifications

Description	Material and Plating	Diameter
Inner Conductor	Copper Clad Steel, Silver, 1 Strands	0.037 in [0.94 mm]
Conductor Type	Solid	
Dielectric	PTFE	0.116 in [2.95 mm]
First Shield	Silver Plated Copper Braid 96% coverage	0.126 in [3.2 mm]
Second Shield	Aluminum Tape	0.132 in [3.35 mm]
Third Shield	Silver Plated Copper Braid 96% coverage	0.155 in [3.94 mm]
Jacket	FEP, Tan	0.195 in [4.95 mm]

Environmental Specifications

Temperature

Operating Range -55 to +200 deg C

Compliance Certifications (see [product page](#) for current document)

Plotted and Other Data

Notes:

Low Loss Flexible PE-P195 Coax Cable Triple Shielded with Tan FEP Jacket from Pasternack Enterprises has same day shipment for domestic and International orders. Our RF, microwave and millimeter wave products maintain a 99.4% availability and are part of the broadest selection in the industry.

Click the following link (or enter part number in "SEARCH" on website) to obtain additional part information including price, inventory and certifications: [Low Loss Flexible PE-P195 Coax Cable Triple Shielded with Tan FEP Jacket PE-P195](#)

URL: <https://www.pasternack.com/precision-0.195-rg142-solid-center-conductor-52-ohm-coax-cable-fep-jacket-pe-p195-p.aspx>

The information contained in this document is accurate to the best of our knowledge and representative of the part described herein. It may be necessary to make modifications to the part and/or the documentation of the part, in order to implement improvements. Pasternack reserves the right to make such changes as required. Unless otherwise stated, all specifications are nominal. Pasternack does not make any representation or warranty regarding the suitability of the part described herein for any particular purpose, and Pasternack does not assume any liability arising out of the use of any part or documentation.

PE-P195 CAD Drawing

Low Loss Flexible PE-P195 Coax Cable Triple Shielded with Tan FEP Jacket



NOTES:
 1. UNLESS OTHERWISE SPECIFIED ALL DIMENSIONS ARE NOMINAL.
 2. ALL SPECIFICATIONS ARE SUBJECT TO CHANGE WITHOUT NOTICE AT ANY TIME.
 3. DIMENSIONS ARE IN INCHES [mm].

DWG TITLE	
PE-P195	
FSCM NO. 53919	CAD FILE 111716
SCALE N/A	SIZE A
	41742

PE PASTERNAK
 THE ENGINEER'S RF SOURCE
 Pasternack Enterprises, Inc.
 P.O. Box 16759 | Irvine | CA | 92623
 Phone: (949) 261-1920 | Fax: (949) 261-7451
 Website: www.pasternack.com | E-Mail: sales@pasternack.com