



## SMA Male Connector Solder Attachment For RG178, RG196

### RF Connectors Technical Data Sheet

**PE4213**

#### Configuration

- SMA Male Connector
- 50 Ohms
- Straight Body Geometry
- Connector Interface Types: RG178, RG196
- 5/16 inch Hex

#### Features

- Max. Operating Frequency 1 GHz
- Good VSWR of 1.3:1
- Gold Plated Brass Contact
- 50 µin minimum contact plating

#### Applications

- General Purpose Test
- Custom Cable Assemblies

#### Description

Pasternack's PE4213 SMA male connector with solder/solder attachment for RG178 and RG196 is part of our full line of RF components available for same-day shipping. Our SMA male connector operates up to a maximum frequency of 1 GHz and offers good VSWR of 1.3:1.

Our SMA male connector PE4213 datasheet specifications and drawing with dimensions are shown below in this PDF. Pasternack's broad catalog of RF, microwave and millimeter wave connectors allows designers to configure and customize their signal connections however they like. Whether the need is to provide an I/O for a board design, or simply create a custom cable assembly configuration, Pasternack has the right connector for the job. Pasternack can also expertly build your custom cable assemblies for you and ship same-day.

#### Electrical Specifications

Description	Minimum	Typical	Maximum	Units
Frequency Range	DC		1,000	MHz
VSWR			1.3:1	
Operating Voltage (AC)			250	Vrms

#### Mechanical Specifications

Weight	0.013 lbs [5.9 g]
Mating Torque	3 to 5 in-lbs [0.34 to 0.57 Nm]

Click the following link (or enter part number in "SEARCH" on website) to obtain additional part information including price, inventory and certifications: [SMA Male Connector Solder Attachment For RG178, RG196 PE4213](#)



## SMA Male Connector Solder Attachment For RG178, RG196

### RF Connectors Technical Data Sheet

**PE4213**

#### Material Specifications

Description	Material	Plating
Contact	Brass	Gold 50 µin minimum
Insulation	PTFE	
Body	Brass	Nickel 100 µin minimum
Coupling Nut	Brass	Nickel 100 µin minimum
Crimp Sleeve	Brass	Nickel

#### Environmental Specifications

##### Temperature

Operating Range -65 to +165 deg C

**Compliance Certifications** (see [product page](#) for current document)

#### Plotted and Other Data

Notes:

SMA Male Connector Solder Attachment For RG178, RG196 from Pasternack Enterprises has same day shipment for domestic and International orders. Our RF, microwave and millimeter wave products maintain a 99.4% availability and are part of the broadest selection in the industry.

Click the following link (or enter part number in "SEARCH" on website) to obtain additional part information including price, inventory and certifications: [SMA Male Connector Solder Attachment For RG178, RG196 PE4213](#)

URL: <https://www.pasternack.com/sma-male-standard-rg178-rg196-connector-pe4213-p.aspx>

The information contained in this document is accurate to the best of our knowledge and representative of the part described herein. It may be necessary to make modifications to the part and/or the documentation of the part, in order to implement improvements. Pasternack reserves the right to make such changes as required. Unless otherwise stated, all specifications are nominal. Pasternack does not make any representation or warranty regarding the suitability of the part described herein for any particular purpose, and Pasternack does not assume any liability arising out of the use of any part or documentation.

# PE4213 CAD Drawing

SMA Male Connector Solder Attachment For RG178, RG196

REVISIONS			
REV.	DESCRIPTION	DATE	APPROVED
B	PE4213 20220826	09/01/2022	AMARG

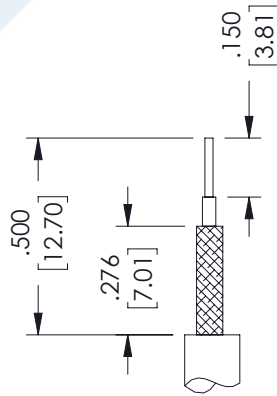
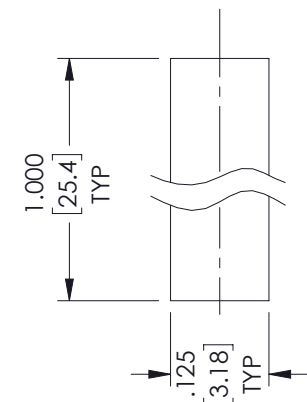
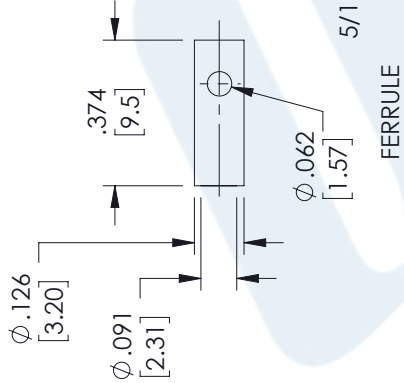
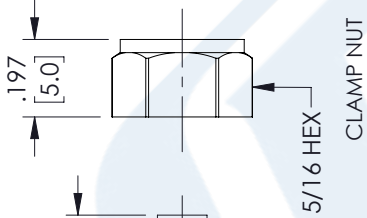
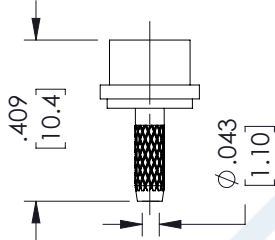
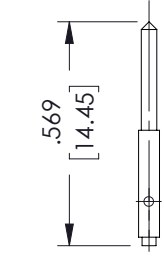
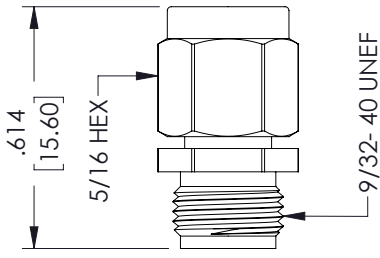

## STRIPPING DIMENSIONS

## ASSEMBLY PROCEDURES

1. STRIP CABLE AS SHOWN. DO NOT NICK CENTER CONDUCTOR. TIN CENTER CONDUCTOR.
2. SLIDE FERRULE, HEAT SHRINK & CLAMP NUT OVER CABLE. FLAIR BRAID & SLIDE WEDGE ASSEMBLY UNDER BRAID WITH CENTER CONDUCTOR PROTRUDING THROUGH HOLE IN INSULATOR. SLIDE FERRULE OVER BRAID & AGAINST CLAMP NUT. SOLDER FERRULE TO BRAID.
3. SOLDER CONTACT TO CENTER CONDUCTOR. CLEAN. INSERT CABLE ASSEMBLY INTO BODY & TIGHTEN TO 8~10 IN.-LBS.

THESE COMMODITIES, TECHNOLOGY OR SOFTWARE WERE EXPORTED FROM THE UNITED STATES IN ACCORDANCE WITH THE EXPORT ADMINISTRATION REGULATIONS. DIVERSION CONTRARY TO U.S. LAW PROHIBITED.

UNLESS OTHERWISE SPECIFIED LEADING DIMENSIONS ARE INCHES DIMENSIONS IN [ ] ARE MILLIMETERS

TOLERANCES:

.X = ±.2	[5.08]	FRACTIONS
.XX = ±.02	[.51]	±.132
.XXX = ±.005	[.13]	ANGLES ± 1°

CABLE LENGTH (L) TOLERANCES:

L ≤ 12	[305]	= +1 [25] / -0
12 [305] < L ≤ 60	[1524]	= +2 [51] / -0
60 [1524] < L ≤ 120	[3048]	= +4 [102] / -0
120 [3048] < L ≤ 300	[7620]	= +6 [152] / -0
300 [7620] < L =	+5%L	/ -0

ALL DIMENSIONS SHOWN ARE FOR REFERENCE ONLY.



Pasternack Enterprises, Inc.  
 P. O. Box 16759, Irvine, CA 92623.  
 Phone: 1.949.261.1920 | 1.866.727.8376  
 Fax: 1.949.261.7451  
 Website: www.pasternack.com  
 E-mail: sales@pasternack.com

THIRD-ANGLE PROJECTION

THE INFORMATION AND DESIGN IN THIS DOCUMENT IS THE PROPERTY OF PASTERNAK CORPORATION. ALL RIGHTS RESERVED.

SHEET 1 OF 1

SCALE N/A

REV B

SIZE	CAGE CODE	DRAWN BY	ITEM NO.
A	53919	WZHANG	PE4213



SMA Female Connector Crimp/Solder Attachment for RG178, RG196

RF Connectors Technical Data Sheet

PE4325

**Configuration**

- SMA Female Connector
- MIL-STD-348
- 50 Ohms
- Straight Body Geometry
- RG178, RG196 Interface Type
- Crimp/Solder Attachment

**Features**

- Gold Plated Beryllium Copper Contact
- Contact plating according to MIL-G-45204

**Applications**

- General Purpose Test
- Custom Cable Assemblies

**Description**

Pasternack's PE4325 SMA female connector with crimp/solder attachment for RG178 and RG196 is part of our full line of RF components available for same-day shipping.

Our SMA female connector PE4325 datasheet specifications and drawing with dimensions are shown below in this PDF. Pasternack's broad catalog of RF, microwave and millimeter wave connectors allows designers to configure and customize their signal connections however they like. Whether the need is to provide an I/O for a board design, or simply create a custom cable assembly configuration, Pasternack has the right connector for the job. Pasternack can also expertly build your custom cable assemblies for you and ship same-day.

**Mechanical Specifications**

**Size**

Length	1.095 in [27.81 mm]
Width/Dia.	0.312 in [7.92 mm]
Weight	0.014 lbs [6.35 g]

**Material Specifications**

Description	Material	Plating
Contact	Beryllium Copper	Gold MIL-G-45204
Insulation	PTFE	
Body	Brass	Nickel QQ-N-290

Click the following link (or enter part number in "SEARCH" on website) to obtain additional part information including price, inventory and certifications: [SMA Female Connector Crimp/Solder Attachment for RG178, RG196 PE4325](#)



## SMA Female Connector Crimp/Solder Attachment for RG178, RG196

### RF Connectors Technical Data Sheet

PE4325

**Compliance Certifications** (see [product page](#) for current document)

#### Plotted and Other Data

Notes:

SMA Female Connector Crimp/Solder Attachment for RG178, RG196 from Pasternack Enterprises has same day shipment for domestic and International orders. Our RF, microwave and millimeter wave products maintain a 99% availability and are part of the broadest selection in the industry.

Click the following link (or enter part number in "SEARCH" on website) to obtain additional part information including price, inventory and certifications: [SMA Female Connector Crimp/Solder Attachment for RG178, RG196 PE4325](#)

URL: <https://www.pasternack.com/sma-female-standard-rg178-rg196-connector-pe4325-p.aspx>

The information contained in this document is accurate to the best of our knowledge and representative of the part described herein. It may be necessary to make modifications to the part and/or the documentation of the part, in order to implement improvements. Pasternack reserves the right to make such changes as required. Unless otherwise stated, all specifications are nominal. Pasternack does not make any representation or warranty regarding the suitability of the part described herein for any particular purpose, and Pasternack does not assume any liability arising out of the use of any part or documentation.

# PE4325 CAD Drawing

SMA Female Connector Crimp/Solder Attachment for RG178, RG196

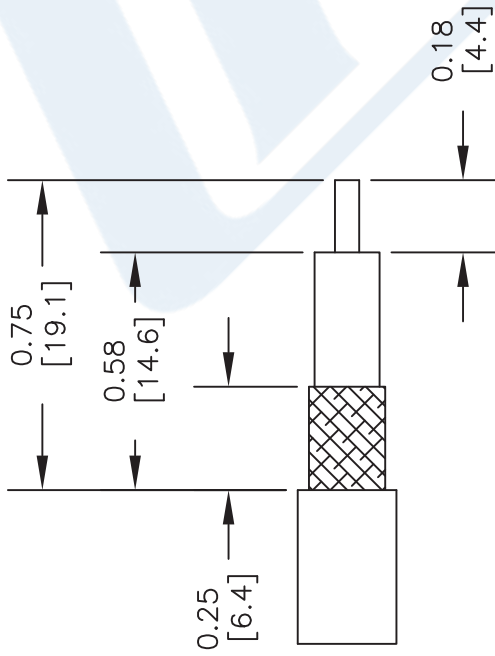
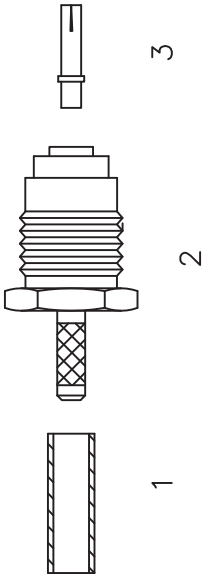

### STRIPPING DIMENSIONS ASSEMBLY PROCEDURES

1. SLIDE FERRULE (1) OVER CABLE; STRIP CABLE AS SHOWN. TIN CENTER CONDUCTOR.
2. FLAIR BRAID & INSERT EXTENSION (2), UNDER BRAID. WITH CENTER CONDUCTOR PROTRUDING THROUGH HOLE IN EXTENSION.
3. SOLDER CONTACT (3) TO CENTER CONDUCTOR. SLIDE FERRULE (1) OVER BRAID & CRIMP. INSTALL CABLE ASSEMBLY INTO BODY & TIGHTEN.

### CRIMP SIZE REQUIRED

CONTACT: SOLDER  
FERRULE: .100" HEX CRIMP TOOL



Pasternack Enterprises, Inc.  
P.O. Box 16759 | Irvine | CA | 92623  
Phone: (949) 261-1920 | Fax: (949) 261-7451  
Website: [www.pasternack.com](http://www.pasternack.com) | E-Mail: [sales@pasternack.com](mailto:sales@pasternack.com)

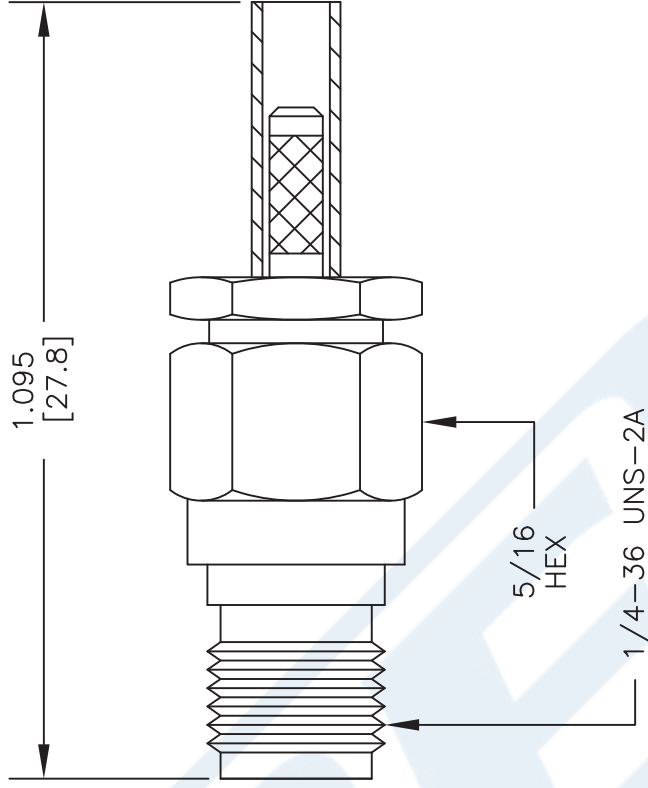

DWG TITLE

**PE4325**

FSCM NO. 53919

NOTES:  
1. UNLESS OTHERWISE SPECIFIED ALL DIMENSIONS ARE NOMINAL.  
2. ALL SPECIFICATIONS ARE SUBJECT TO CHANGE WITHOUT NOTICE AT ANY TIME.  
3. DIMENSIONS ARE IN INCHES [mm].  
4. FITS MIL-C-17 AND EQUIVALENT CABLES.

CAD FILE 010413-A

SCALE N/A

SIZE A

2233

## Flexible RG178 Coax Cable Single Shielded with Tan FEP Jacket

### RF Cables Technical Data Sheet

RG178B/U

#### Configuration

- Flexible Cable
- 1 Shield(s)

#### Electrical Specifications

Description	Minimum	Typical	Maximum	Units
Frequency Range	DC		3	GHz
Impedance		50		Ohms
Velocity of Propagation		70		%
Operating Voltage (AC)			1,000	Vrms
Nominal Capacitance		29.4 [96.46]		pF/ft [pF/m]

#### Performance by Frequency Band

Description	F1	F2	F3	F4	F5	Units
Frequency	0.1	0.4	1	3		GHz
Attenuation, Typ	13.81	27.8	44.41	78.4		dB/100ft
	45.31	91.21	145.7	257.22		dB/100m

#### Mechanical Specifications

Diameter	0.072 in [1.83 mm]
Weight	0.005 lbs/ft [0.01 Kg/m]
Min. Bend Radius (Repeated)	0.4 in [10.16 mm]

#### Construction Specifications

Description	Material and Plating	Diameter
Inner Conductor	Copper Clad Steel, Silver, 7 Strands	0.012 in [0.3 mm]
Conductor Type	Stranded	
Dielectric	PTFE	0.034 in [0.86 mm]
First Shield	Silver Plated Copper Braid	0.051 in [1.3 mm]

Click the following link (or enter part number in "SEARCH" on website) to obtain additional part information including price, inventory and certifications: [Flexible RG178 Coax Cable Single Shielded with Tan FEP Jacket RG178B/U](#)

## Flexible RG178 Coax Cable Single Shielded with Tan FEP Jacket

### RF Cables Technical Data Sheet

RG178B/U

Jacket	FEP, Tan	0.072 in [1.83 mm]
--------	----------	--------------------

#### Environmental Specifications

##### Temperature

Operating Range -55 to +200 deg C

**Compliance Certifications** (see [product page](#) for current document)

#### Plotted and Other Data

Notes:

Flexible RG178 Coax Cable Single Shielded with Tan FEP Jacket from Pasternack Enterprises has same day shipment for domestic and International orders. Our RF, microwave and millimeter wave products maintain a 99.4% availability and are part of the broadest selection in the industry.

Click the following link (or enter part number in "SEARCH" on website) to obtain additional part information including price, inventory and certifications: [Flexible RG178 Coax Cable Single Shielded with Tan FEP Jacket RG178B/U](#)

URL: <https://www.pasternack.com/flexible-0.075-rg178-50-ohm-coax-cable-fep-jacket-rg178b-u-p.aspx>

The information contained in this document is accurate to the best of our knowledge and representative of the part described herein. It may be necessary to make modifications to the part and/or the documentation of the part, in order to implement improvements. Pasternack reserves the right to make such changes as required. Unless otherwise stated, all specifications are nominal. Pasternack does not make any representation or warranty regarding the suitability of the part described herein for any particular purpose, and Pasternack does not assume any liability arising out of the use of any part or documentation.

# RG178B/U CAD Drawing

Flexible RG178 Coax Cable Single Shielded with Tan FEP Jacket



NOTES:  
1. UNLESS OTHERWISE SPECIFIED ALL DIMENSIONS ARE NOMINAL.  
2. ALL SPECIFICATIONS ARE SUBJECT TO CHANGE WITHOUT NOTICE AT ANY TIME.  
3. DIMENSIONS ARE IN INCHES [mm].

DWG TITLE  
**RG178B/U**

CAGE CODE 53919

CAD FILE 062117

SCALE N/A

SIZE A

2233

**PE PASTERNAK®**  
THE ENGINEER'S RF SOURCE  
Pasternack Enterprises, Inc.  
P.O. Box 16759 | Irvine | CA | 92623

Phone: (949) 261-1920 | Fax: (949) 261-7451

Website: [www.pasternack.com](http://www.pasternack.com) | E-Mail: [sales@pasternack.com](mailto:sales@pasternack.com)