



SSMB Plug Right Angle Connector Crimp/Solder Attachment for RG174, RG179, RG316, RG188, PE-B100, PE-C100, 0.100 inch, LMR-100

RF Connectors Technical Data Sheet

PE4334

Configuration

- SSMB Plug Connector
- MIL-STD-348
- 50 Ohms
- Right Angle Body Geometry
- RG174, RG179, RG316, RG188, PE-B100, PE-C100, 0.100 inch, LMR-100 Interface Type
- Crimp/Solder Attachment

Features

- Gold Plated Contact
- Contact plating according to MIL-G-45204

Applications

- General Purpose Test
- Custom Cable Assemblies

Description

Pasternack's PE4334 SSMB plug right angle connector with crimp/solder attachment for RG174, RG179, RG316, RG188, PE-B100, PE-C100, 0.100 inch and LMR-100 is part of our full line of RF components available for same-day shipping. Its right angle body geometry allows for easier connections in tight spaces.

Our SSMB plug right angle connector PE4334 datasheet specifications and drawing with dimensions are shown below in this PDF. Pasternack's broad catalog of RF, microwave and millimeter wave connectors allows designers to configure and customize their signal connections however they like. Whether the need is to provide an I/O for a board design, or simply create a custom cable assembly configuration, Pasternack has the right connector for the job. Pasternack can also expertly build your custom cable assemblies for you and ship same-day.

Mechanical Specifications

Size

Length	0.475 in [12.07 mm]
Width/Dia.	0.188 in [4.78 mm]
Height	0.435 in [11.05 mm]
Weight	0.005 lbs [2.27 g]

Material Specifications

Description	Material	Plating
Contact		Gold MIL-G-45204
Insulation	PTFE	
Body	Brass	Gold MIL-G-45204

Click the following link (or enter part number in "SEARCH" on website) to obtain additional part information including price, inventory and certifications: [SSMB Plug Right Angle Connector Crimp/Solder Attachment for RG174, RG179, RG316, RG188, PE-B100, PE-C100, 0.100 inch, LMR-100 PE4334](#)



SSMB Plug Right Angle Connector Crimp/Solder Attachment for RG174, RG179, RG316, RG188, PE-B100, PE-C100, 0.100 inch, LMR-100

RF Connectors Technical Data Sheet

PE4334

Compliance Certifications (see [product page](#) for current document)

Plotted and Other Data

Notes:

SSMB Plug Right Angle Connector Crimp/Solder Attachment for RG174, RG179, RG316, RG188, PE-B100, PE-C100, 0.100 inch, LMR-100 from Pasternack Enterprises has same day shipment for domestic and International orders. Our RF, microwave and millimeter wave products maintain a 99% availability and are part of the broadest selection in the industry.

Click the following link (or enter part number in "SEARCH" on website) to obtain additional part information including price, inventory and certifications: [SSMB Plug Right Angle Connector Crimp/Solder Attachment for RG174, RG179, RG316, RG188, PE-B100, PE-C100, 0.100 inch, LMR-100 PE4334](#)

URL: <https://www.pasternack.com/ssmb-plug-standard-rg174-rg179-rg316-rg188-connector-pe4334-p.aspx>

The information contained in this document is accurate to the best of our knowledge and representative of the part described herein. It may be necessary to make modifications to the part and/or the documentation of the part, in order to implement improvements. Pasternack reserves the right to make such changes as required. Unless otherwise stated, all specifications are nominal. Pasternack does not make any representation or warranty regarding the suitability of the part described herein for any particular purpose, and Pasternack does not assume any liability arising out of the use of any part or documentation.

PE4334 CAD Drawing

SSMB Plug Right Angle Connector Crimp/Solder Attachment for RG174,
RG179, RG316, RG188, PE-B100, PE-C100, 0.100 inch, LMR-100

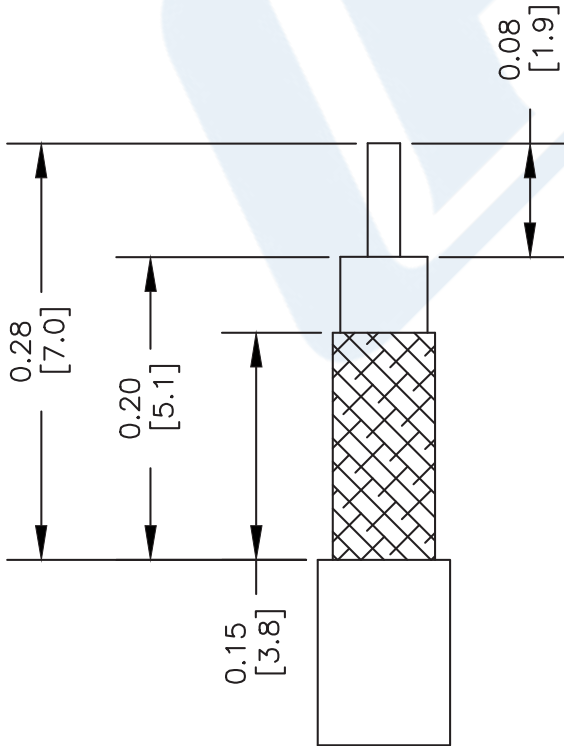

STRIPPING DIMENSIONS

ASSEMBLY PROCEDURES

1. STRIP CABLE AS SHOWN.
2. INSTALL CABLE INTO BODY OF CONNECTOR AND SOFT SOLDER CENTER CONDUCTOR IN PLACE.
3. SLIDE FERRULE OVER BRAID & SEAT AGAINST BODY. CRIMP FERRULE. PRESS CAP DOWN.

CRIMP SIZE REQUIRED

FERRULE: .128" HEX CRIMP TOOL

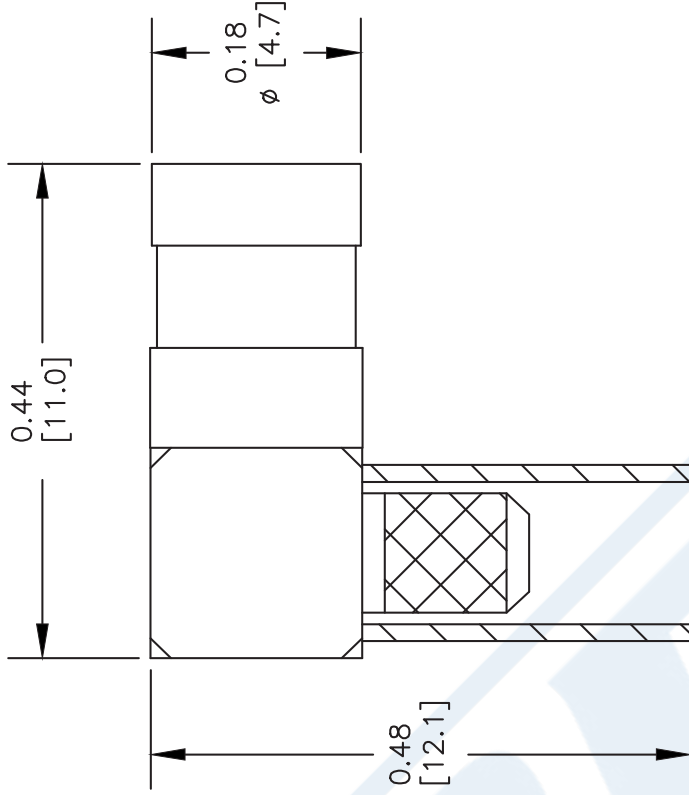

DWG TITLE

PE4334

NOTES:
1. UNLESS OTHERWISE SPECIFIED ALL DIMENSIONS ARE NOMINAL.
2. ALL SPECIFICATIONS ARE SUBJECT TO CHANGE WITHOUT NOTICE AT ANY TIME.
3. DIMENSIONS ARE IN INCHES [mm].
4. FITS MIL-C-17 AND EQUIVALENT CABLES.

REV. -

FSCM NO. 53919

CAD FILE 080405

SCALE N/A

SIZE A

2233



Pasternack Enterprises, Inc.
P.O. Box 16759 | Irvine | CA | 92623

Phone: (949) 261-1920 | Fax: (949) 261-7451

Website: www.pasternack.com | E-Mail: sales@pasternack.com



SMA Female Connector Crimp/Solder Attachment for RG316, RG174, LMR-100, RG188, PE-B100, PE-C100, 0.100 inch

RF Connectors
Technical Data Sheet

PE45137

Configuration

- SMA Female Connector
- MIL-STD-348A
- 50 Ohms
- Straight Body Geometry
- Connector Interface Types: RG316, RG174, LMR-100, RG188, PE-B100, PE-C100, 0.100 inch

Features

- Max. Operating Frequency 6 GHz
- Good VSWR of 1.3:1
- Gold Plated Beryllium Copper Contact
- 50µ in. minimum contact plating

Applications

- General Purpose Test
- Custom Cable Assemblies

Description

Pasternack's PE45137 SMA female connector with crimp/solder attachment for RG316, RG174, LMR-100, RG188, PE-B100, PE-C100 and 0.100 inch is part of our full line of RF components available for same-day shipping. Our SMA female connector operates up to a maximum frequency of 6 GHz and offers good VSWR of 1.3:1.

Our SMA female connector PE45137 datasheet specifications and drawing with dimensions are shown below in this PDF. Pasternack's broad catalog of RF, microwave and millimeter wave connectors allows designers to configure and customize their signal connections however they like. Whether the need is to provide an I/O for a board design, or simply create a custom cable assembly configuration, Pasternack has the right connector for the job. Pasternack can also expertly build your custom cable assemblies for you and ship same-day.

Electrical Specifications

Description	Minimum	Typical	Maximum	Units
Frequency Range	DC		6	GHz
VSWR			1.3:1	
Operating Voltage (AC)			335	Vrms

Performance by Frequency

Description	F1	F2	F3	F4	F5	Units
Frequency Range	DC to 3					GHz
VSWR, Max	1.21:1					

Mechanical Specifications

Size	
Length	0.591 in [15.01 mm]
Width/Dia.	0.25 in [6.35 mm]

Click the following link (or enter part number in "SEARCH" on website) to obtain additional part information including price, inventory and certifications: [SMA Female Connector Crimp/Solder Attachment for RG316, RG174, LMR-100, RG188, PE-B100, PE-C100, 0.100 inch PE45137](#)



SMA Female Connector Crimp/Solder Attachment for RG316, RG174, LMR-100, RG188, PE-B100, PE-C100, 0.100 inch

RF Connectors
Technical Data Sheet

PE45137

Weight 0.01 lbs [4.54 g]

Material Specifications

Description	Material	Plating
Contact	Beryllium Copper	Gold 50μ in. minimum
Insulation	Teflon	
Outer Conductor	Brass	Gold 3μ in. minimum
Body	Brass	Gold 3μ in. minimum

Environmental Specifications

Temperature

Operating Range -65 to +165 deg C

Compliance Certifications (see [product page](#) for current document)

Plotted and Other Data

Notes:

SMA Female Connector Crimp/Solder Attachment for RG316, RG174, LMR-100, RG188, PE-B100, PE-C100, 0.100 inch from Pasternack Enterprises has same day shipment for domestic and International orders. Our RF, microwave and millimeter wave products maintain a 99.4% availability and are part of the broadest selection in the industry.

Click the following link (or enter part number in "SEARCH" on website) to obtain additional part information including price, inventory and certifications: [SMA Female Connector Crimp/Solder Attachment for RG316, RG174, LMR-100, RG188, PE-B100, PE-C100, 0.100 inch PE45137](#)

URL: <https://www.pasternack.com/sma-female-rg316-rg174-lmr-100-connector-pe45137-p.aspx>

The information contained in this document is accurate to the best of our knowledge and representative of the part described herein. It may be necessary to make modifications to the part and/or the documentation of the part, in order to implement improvements. Pasternack reserves the right to make such changes as required. Unless otherwise stated, all specifications are nominal. Pasternack does not make any representation or warranty regarding the suitability of the part described herein for any particular purpose, and Pasternack does not assume any liability arising out of the use of any part or documentation.

PE45137 CAD Drawing

SMA Female Connector Crimp/Solder Attachment for RG316, RG174, LMR-100, RG188, PE-B100, PE-C100, 0.100 inch

REVISIONS			
REV.	DESCRIPTION	DATE	APPROVED
A	PCR PE45137 20200921	10/23/20	SRAUTUS

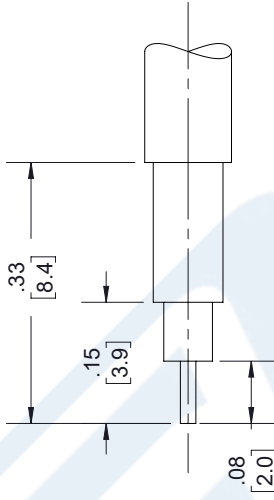
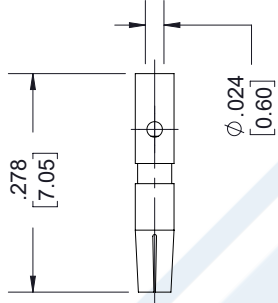
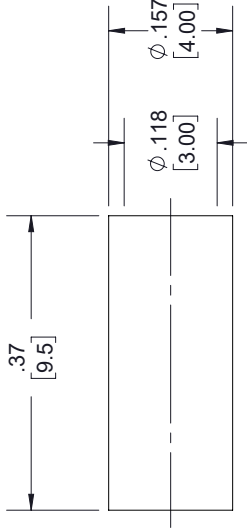
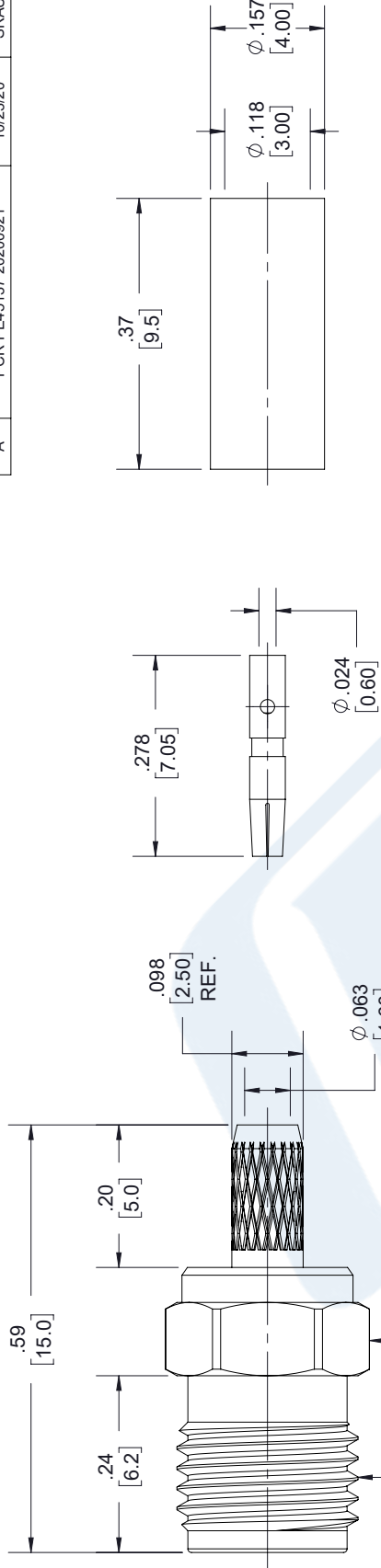

STRIPPING DIMENSIONS

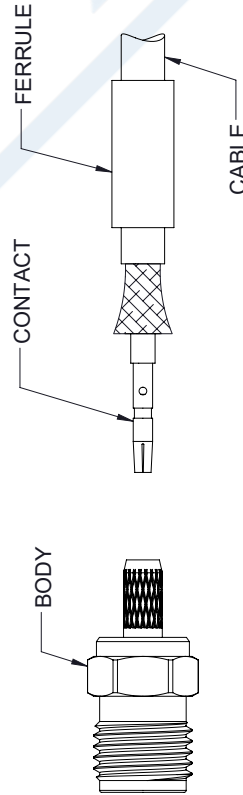

ASSEMBLY PROCEDURES

1. STRIP CABLE TO THE DIMENSIONS SHOWN, DO NOT NICK CENTER CONDUCTOR OR BRAID.
2. SLIDE FERRULE ONTO CABLE.
3. PUSH CENTER CONDUCTOR FULLY INTO CONTACT AND SOLDER, REMOVE ANY EXCESS SOLDER.
4. FLARE BRAID AND INSERT CONTACT INTO THE BODY UNTIL IT SEATS.
5. SLIDE FERRULE OVER BRAID AND CRIMP WITH .138" [3.5] HEX CRIMP TOOL.

UNLESS OTHERWISE SPECIFIED LEADING DIMENSIONS ARE IN INCHES DIMENSIONS IN [] ARE MILLIMETERS

TOLERANCES:

.X = ± .2 [5.08] FRACTIONS ± 1/32
 .XX = ± .02 [.51] ANGLES ± 1°
 .XXX = ± .005 [.13] CABLE LENGTH (L) TOLERANCES:
 L ≤ 12 [305] = +1 [25] / -0
 12 [305] < L ≤ 60 [1524] = +2 [51] / -0
 60 [1524] < L ≤ 120 [3048] = +4 [102] / -0
 120 [3048] < L ≤ 300 [7620] = +6 [152] / -0
 300 [7620] < L = +5%L / -0

ALL DIMENSIONS SHOWN ARE FOR REFERENCE ONLY.



Pasternack Enterprises, Inc.
 P.O. Box 16759, Irvine, CA 92623.
 Phone: 1.949.261.1920 | 1.866.727.8376
 Fax: 1.949.261.7451
 Website: www.pasternack.com
 E-mail: sales@pasternack.com

THIRD-ANGLE PROJECTION

THE INFORMATION AND DESIGN ARE PROPERTY OF PASTERNAK CORPORATION ALL RIGHTS RESERVED.

SHEET 1 OF 1
 SCALE N/A

SIZE	CAGE CODE	DRAWN BY	ITEM NO.	REV
A	53919	SLI	PE45137	A



Flexible RG174 Coax Cable Single Shielded with Black PVC Jacket

RF Cables Technical Data Sheet

Times Microwave Systems Coax Cable Specification Configuration

- Flexible Cable
- 1 Shield(s)

Electrical Specifications

Description	Minimum	Typical	Maximum	Units
Frequency Range	DC		1,000	MHz
Impedance		50		Ohms
Velocity of Propagation		66		%
Nominal Capacitance		31.08 [101.97]		pF/ft [pF/m]
Power@ 1GHz			17	Watts

Performance by Frequency Band

Description	F1	F2	F3	F4	F5	Units
Frequency	100	400	1,000			MHz
Attenuation, Typ	8.4	19	32			dB/100ft dB/100m
	27.56	62.34	104.99			

Mechanical Specifications

Diameter	0.11 in [2.79 mm]
Weight	0.009 lbs/ft [0.01 kg/m]

Construction Specifications

Description	Material and Plating	Diameter
Inner Conductor	Copper Clad Steel, 7 Strands	0.019 in [0.48 mm]
Conductor Type	Stranded	
Dielectric	PE	0.06 in [1.52 mm]
First Shield	Tinned Copper Braid	0.078 in [1.98 mm]

Click the following link (or enter part number in "SEARCH" on website) to obtain additional part information including price, inventory and certifications: [Flexible RG174 Coax Cable Single Shielded with Black PVC Jacket RG174A/U](#)



Flexible RG174 Coax Cable Single
Shielded with Black PVC Jacket

RF Cables
Technical Data Sheet

Jacket	PVC, Black	0.11 in [2.79 mm]
--------	------------	-------------------

Environmental Specifications

Temperature

Operating Range

-40 to +80 deg C

Compliance Certifications (see [product page](#) for current document)

Plotted and Other Data

Notes:

Flexible RG174 Coax Cable Single Shielded with Black PVC Jacket from Pasternack Enterprises has same day shipment for domestic and International orders. Our RF, microwave and millimeter wave products maintain a 99.4% availability and are part of the broadest selection in the industry.

Click the following link (or enter part number in "SEARCH" on website) to obtain additional part information including price, inventory and certifications: [Flexible RG174 Coax Cable Single Shielded with Black PVC Jacket RG174A/U](#)

URL: <https://www.pasternack.com/flexible-0.100-rg174-50-ohm-coax-cable-pvc-jacket-rg174a-u-p.aspx>

The information contained in this document is accurate to the best of our knowledge and representative of the part described herein. It may be necessary to make modifications to the part and/or the documentation of the part, in order to implement improvements. Pasternack reserves the right to make such changes as required. Unless otherwise stated, all specifications are nominal. Pasternack does not make any representation or warranty regarding the suitability of the part described herein for any particular purpose, and Pasternack does not assume any liability arising out of the use of any part or documentation.



SECTION VIEW

NOTE:

*STANDARD TOLERANCES APPLY ONLY TO DIMENSIONS IN INCHES

STANDARD	TOLERANCES
.X	± 0.2
.XX	± 0.01
.XXX	± 0.005



Pasternack Enterprises, Inc.
 P.O. Box 16759 | Irvine | CA | 92623
Phone: (949) 261-1920 | **Fax:** (949) 261-7451
Website: www.pasternack.com | **E-Mail:** sales@pasternack.com

DWG TITLE

RG174A/U

NOTES:
 1. UNLESS OTHERWISE SPECIFIED ALL DIMENSIONS ARE NOMINAL.
 2. ALL SPECIFICATIONS ARE SUBJECT TO CHANGE WITHOUT NOTICE AT ANY TIME
 3. DIMENSIONS ARE IN INCHES [mm].

CAGE CODE 53919

CAD FILE 05/25/18

SCALE N/A

SIZE A

7361