



## SMA Male Right Angle Connector Crimp/Solder Attachment for RG316, RG174, RG188

### RF Connectors Technical Data Sheet

PE45144

#### Configuration

- SMA Male Connector
- 50 Ohms
- Right Angle Body Geometry
- Connector Interface Types: RG316, RG174, RG188
- 16-May in Hex

#### Features

- Max. Operating Frequency 12.4 GHz
- Gold Plated Brass Contact

#### Applications

- General Purpose Test
- Custom Cable Assemblies

#### Description

Pasternack's PE45144 SMA male right angle connector with crimp/solder attachment for RG316, RG174 and RG188 is part of our full line of RF components available for same-day shipping. Our SMA male connector operates up to a maximum frequency of 12.4 GHz. Its right angle body geometry allows for easier connections in tight spaces.

Our SMA male right angle connector PE45144 datasheet specifications and drawing with dimensions are shown below in this PDF. Pasternack's broad catalog of RF, microwave and millimeter wave connectors allows designers to configure and customize their signal connections however they like. Whether the need is to provide an I/O for a board design, or simply create a custom cable assembly configuration, Pasternack has the right connector for the job. Pasternack can also expertly build your custom cable assemblies for you and ship same-day.

#### Electrical Specifications

Description	Minimum	Typical	Maximum	Units
Frequency Range	DC		12.4	GHz

#### Mechanical Specifications

<b>Size</b>	
Length	0.512 in [13 mm]
Width/Dia.	0.689 in [17.50 mm]
Weight	0.015 lbs [6.8 g]
Mating Torque	5 in-lbs [0.57 Nm]

Click the following link (or enter part number in "SEARCH" on website) to obtain additional part information including price, inventory and certifications: [SMA Male Right Angle Connector Crimp/Solder Attachment for RG316, RG174, RG188 PE45144](#)



## SMA Male Right Angle Connector Crimp/Solder Attachment for RG316, RG174, RG188

### RF Connectors Technical Data Sheet

PE45144

#### Material Specifications

Description	Material	Plating
Contact	Brass	Gold
Insulation	Teflon	
Body	Brass	Gold
Coupling Nut	Brass	Gold

#### Environmental Specifications

**Compliance Certifications** (see [product page](#) for current document)

#### Plotted and Other Data

Notes:

SMA Male Right Angle Connector Crimp/Solder Attachment for RG316, RG174, RG188 from Pasternack Enterprises has same day shipment for domestic and International orders. Our RF, microwave and millimeter wave products maintain a 99.4% availability and are part of the broadest selection in the industry.

Click the following link (or enter part number in "SEARCH" on website) to obtain additional part information including price, inventory and certifications: [SMA Male Right Angle Connector Crimp/Solder Attachment for RG316, RG174, RG188 PE45144](#)

URL: <https://www.pasternack.com/sma-male-rg316-rg174-rg188-connector-pe45144-p.aspx>

The information contained in this document is accurate to the best of our knowledge and representative of the part described herein. It may be necessary to make modifications to the part and/or the documentation of the part, in order to implement improvements. Pasternack reserves the right to make such changes as required. Unless otherwise stated, all specifications are nominal. Pasternack does not make any representation or warranty regarding the suitability of the part described herein for any particular purpose, and Pasternack does not assume any liability arising out of the use of any part or documentation.

# PE45144 CAD Drawing

SMA Male Right Angle Connector Crimp/Solder Attachment for RG316, RG174, RG188

REV.	DESCRIPTION	DATE	APPROVED
B	ADJUST FERRULE LENGTH	4/12/22	SRAUTUS

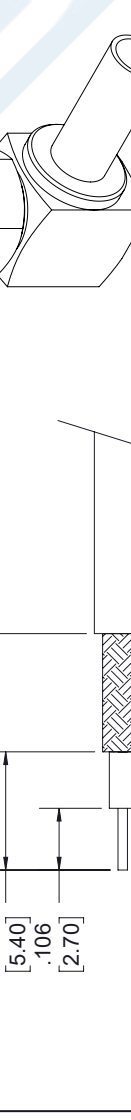
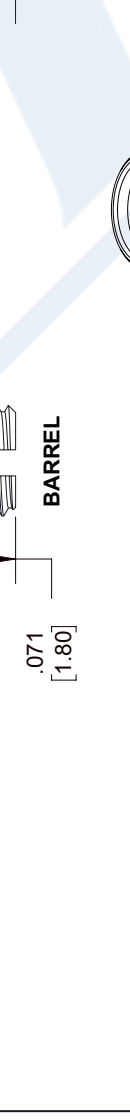
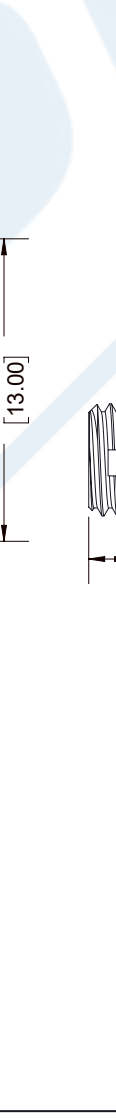
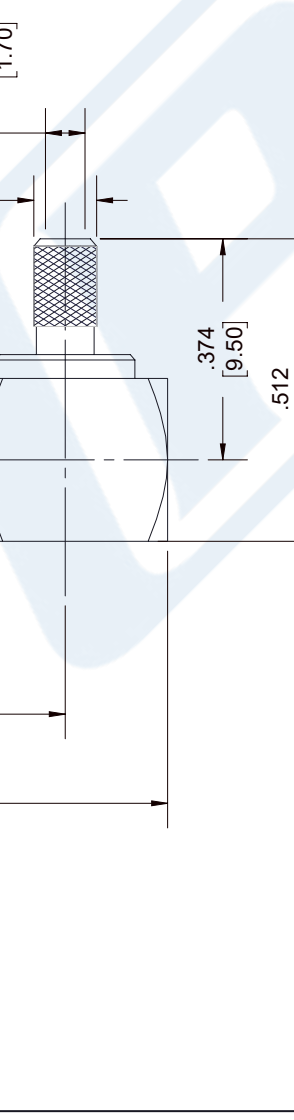
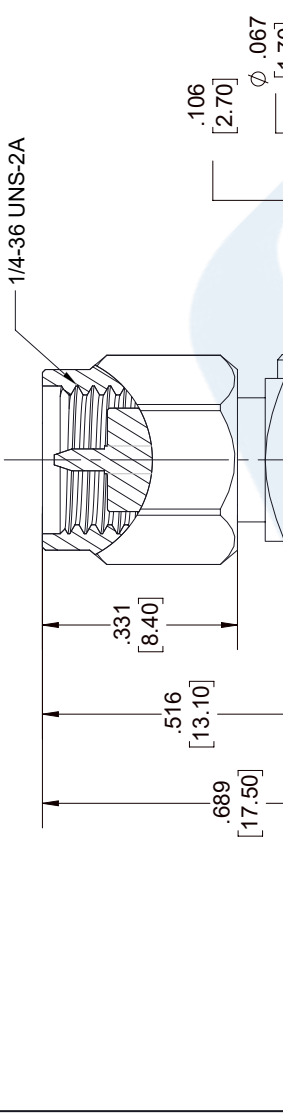
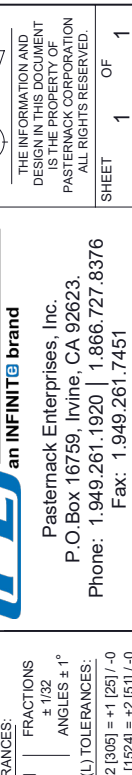
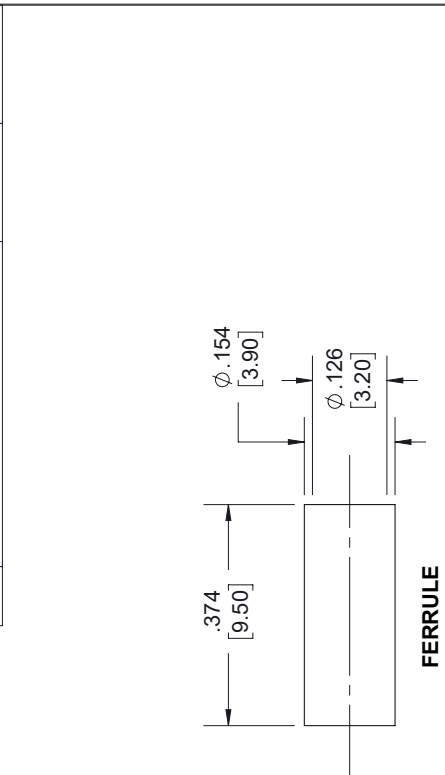

TNC Female Bulkhead Mount Connector Crimp/Solder Attachment for RG174, RG316, RG188, 0.100 inch, PE-B100, PE-C100, LMR-100, IP67 Rated



**PE44899**

**Configuration**

- TNC Female Connector
- MIL-STD-348
- 50 Ohms
- Straight Body Geometry
- Connector Interface Types: RG174, RG316, RG188, .100 inch, PE-B100, PE-C100, LMR-100
- Bulkhead

**Features**

- Max. Operating Frequency 3 GHz
- Excellent VSWR of 1.25:1
- Gold Plated Phosphor Bronze Contact
- IP67 Rated (Unmated)

**Applications**

- General Purpose Test
- Rack and Panel Mount Applications
- Custom Cable Assemblies

**Description**

Pasternack's PE44899 TNC female bulkhead connector with crimp/solder attachment for RG174, RG316, RG188, .100 inch, PE-B100, PE-C100 and LMR-100 is part of our full line of RF components available for same-day shipping. Our TNC female connector operates up to a maximum frequency of 3 GHz and offers excellent VSWR of 1.25:1. This TNC bulkhead connector allows designers to create external connections on their product enclosures, and can be used in a variety of other rack mount and panel mount applications. The connector has an IP67 rating to protect against dust and temporary moisture protection under immersion conditions.

Our TNC female bulkhead connector PE44899 datasheet specifications and drawing with dimensions are shown below in this PDF. Pasternack's broad catalog of RF, microwave and millimeter wave connectors allows designers to configure and customize their signal connections however they like. Whether the need is to provide an I/O for a board design, or simply create a custom cable assembly configuration, Pasternack has the right connector for the job. Pasternack can also expertly build your custom cable assemblies for you and ship same-day.

**Electrical Specifications**

Description	Minimum	Typical	Maximum	Units
Frequency Range	DC		3	GHz
VSWR			1.25:1	
Impedance		50		Ohms

**Mechanical Specifications**

**Size**

Length	1.36 in [34.54 mm]
Width	0.68 in [17.27 mm]
Weight	0.047 lbs [21.32 g]

**Material Specifications**

Description	Material	Plating
Contact	Phosphor Bronze	Gold
Insulation	PTFE	
Body	Brass	Nickel

TNC Female Bulkhead Mount Connector Crimp/Solder Attachment for RG174, RG316, RG188, 0.100 inch, PE-B100, PE-C100, LMR-100, IP67 Rated



**PE44899**

---

### Environmental Specifications

#### Temperature

Operating Range

-65 to +165 deg C

Ingress Protection (IP) Rating

IP67 Rated (Unmated)

**Compliance Certifications** (see [product page](#) for current document)

### Plotted and Other Data

Notes:

TNC Female Bulkhead Mount Connector Crimp/Solder Attachment for RG174, RG316, RG188, 0.100 inch, PE-B100, PE-C100, LMR-100, IP67 Rated from Pasternack Enterprises has same day shipment for domestic and International orders. Our RF, microwave and millimeter wave products maintain a 99.4% availability and are part of the broadest selection in the industry.

Click the following link (or enter part number in "SEARCH" on website) to obtain additional part information including price, inventory and certifications: [TNC Female Bulkhead Mount Connector Crimp/Solder Attachment for RG174, RG316, RG188, 0.100 inch, PE-B100, PE-C100, LMR-100, IP67 Rated PE44899](#)

URL: <https://www.pasternack.com/tnc-female-standard-rg316-u-rg174a-u-rg188-connector-pe44899-p.aspx>

The information contained within this document is accurate to the best of our knowledge and representative of the part described herein. It may be necessary to make modifications to the part and/or the documentation of the part in order to implement improvements. Pasternack Enterprises reserves the right to make such changes as required. Unless otherwise stated, all specifications are nominal. Pasternack Enterprises does not make any representation or warranty regarding the suitability of the part described herein for any particular purpose, and Pasternack Enterprises does not assume liability arising out of the use of any part or document.

# PE44899 CAD Drawing

TNC Female Bulkhead Mount Connector Crimp/Solder Attachment for RG174, RG316, RG188, 0.100 inch, PE-B100, PE-C100, LMR-100, IP67 Rated

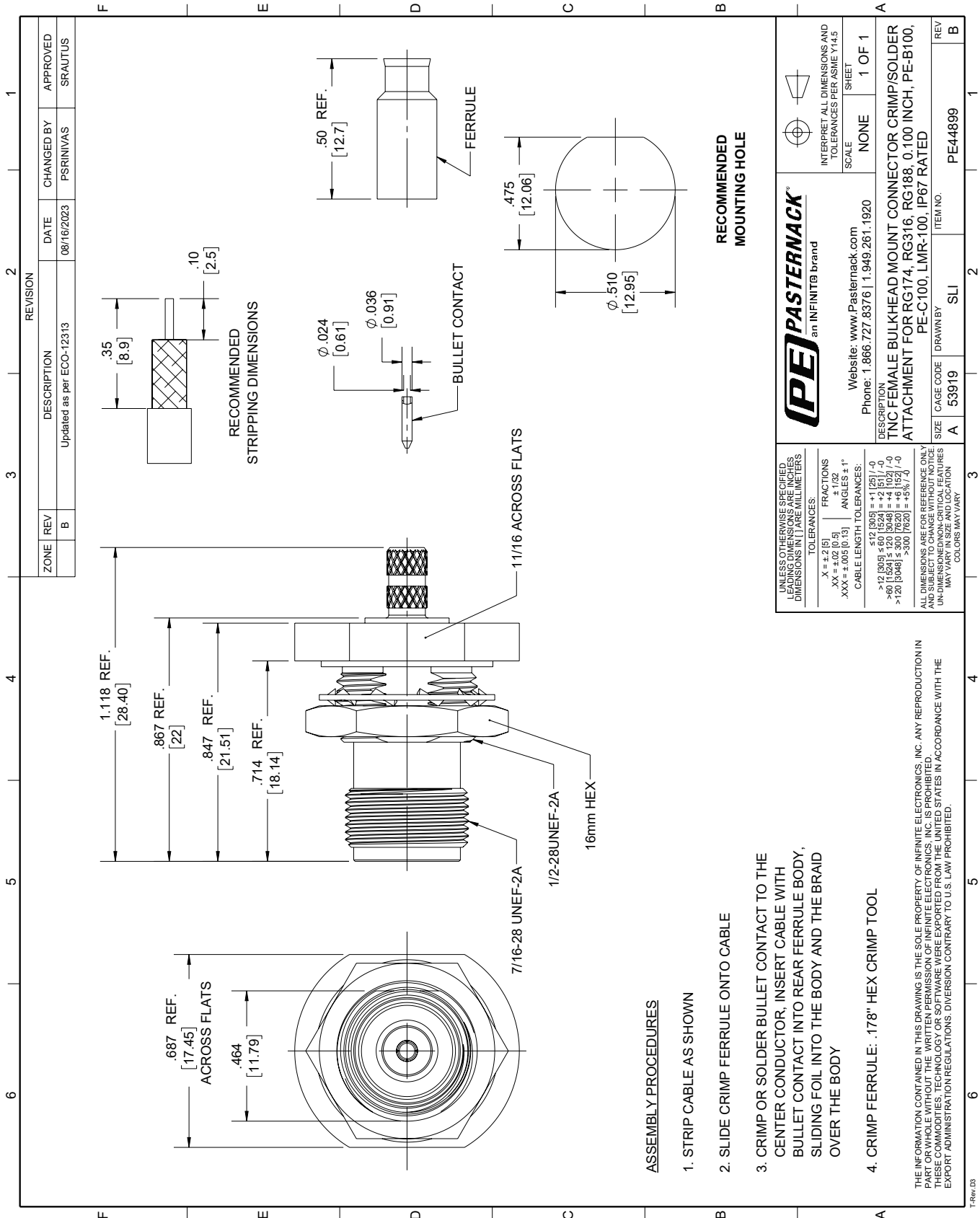

# LMR<sup>®</sup>-100A Flexible Low Loss Communications Coax

## Ideal for...

- Drop-in Replacement for RG-316/RG-174 (uses standard connectors)
- Jumper Assemblies in Wireless Communications Systems
- Short Antenna Feeder runs
- Any application (e.g. WLL, GPS, LMR, WLAN, WiSP, WiMax, SCADA, Mobile Antennas) requiring an easily routed, low loss RF cable

• **LMR<sup>®</sup>-PVC** is designed for low loss general-purpose indoor/outdoor applications and is somewhat more flexible than the standard polyethylene jacketed LMR.

• **LMR<sup>®</sup>-PVC-W** is a white-jacketed version of LMR-PVC for marine and other indoor/outdoor applications where color compatibility is desired.

• **Flexibility** and bendability are hallmarks of the LMR-100A cable design. The flexible outer conductor enables the tightest bend radius available for any cable of similar size and performance.

• **Low Loss** is another hallmark feature of LMR-100A. Size for size LMR has the lowest loss of any flexible cable and comparable loss to semirigid hard-line cables.

• **RF Shielding** is 50 dB greater than typical single shielded coax (40 dB). The multi-ply bonded foil outer conductor is rated conservatively at > 90 dB (i.e. >180 dB between two adjacent cables).

• **Weatherability:** LMR-100A cables designed for outdoor exposure incorporate the best materials for UV resistance and have life expectancy in excess of 20 years.

• **Connectors:** A wide variety of connectors are available for LMR-100A cable, including all common interface types, reverse polarity, and a choice of solder or non-solder center pins. Most LMR connectors employ crimp outer attachment using standard hex crimp sizes.

• **Cable Assemblies:** All LMR-100A cable types are available as pre-terminated cable assemblies. Refer to the section on FlexTech for further details.

Part Description					Stock
Part Number	Application	Jacket	Color	Code	
LMR-100A-FR	Indoor/Outdoor Riser CMR	FRPE	Black	54037	
LMR-100A-PVC	Indoor/Outdoor	PVC	Black	54119	
LMR-100A-PVC-W	Indoor/Outdoor	PVC	White	54200	

PVC = Poly Vinyl Chloride; MTO = Made to Order



Construction Specifications			
Description	Material	In.	(mm)
Inner Conductor	Solid BCCS	0.018	(0.46)
Dielectric	Solid PE	0.060	(1.52)
Outer Conductor	Aluminum Tape	0.065	(1.65)
Overall Braid	Tinned Copper	0.083	(2.11)
Jacket	(see table above)	0.110	(2.79)

Mechanical Specifications			
Performance Property	Units	US	(metric)
Bend Radius: installation	in. (mm)	0.25	(6.4)
Bend Radius: repeated	in. (mm)	1	(25.4)
Bending Moment	ft-lb (N-m)	0.1	(0.014)
Weight	lb/ft (kg/m)	0.0092	(.014)
Tensile Strength	lb (kg)	15	(6.8)
Flat Plate Crush	lb/in. (kg/mm)	10	(0.18)

Environmental Specifications		
Performance Property	°F	°C
Installation Temperature Range	-40/+185	-40/+85
Storage Temperature Range	-94/+185	-70/+85
Operating Temperature Range	-40/+185	-40/+85

Electrical Specifications			
Performance Property	Units	US	(metric)
Velocity of Propagation	%	66	
Dielectric Constant	NA	2.30	
Time Delay	nS/ft (nS/m)	1.54	(5.05)
Impedance	ohms	50	
Capacitance	pF/ft (pF/m)	30.8	(101.1)
Inductance	uH/ft (uH/m)	0.077	(0.25)
Shielding Effectiveness	dB	>90	
DC Resistance			
Inner Conductor	ohms/1000ft (/km)	81.0	(266)
Outer Conductor	ohms/1000ft (/km)	9.5	(31.2)
Voltage Withstand	Volts DC	500	
Jacket Spark	Volts RMS	2000	
Peak Power	kW	0.6	

**Attenuation vs. Frequency (typical)**



Frequency (MHz)	30	50	150	220	450	900	1500	1800	2000	2500	5800
<b>Attenuation dB/100 ft</b>	3.9	5.1	8.9	10.9	15.8	22.8	30.1	33.2	35.2	39.8	64.1
<b>Attenuation dB/100 m</b>	12.9	16.7	29.4	35.8	51.9	74.9	98.7	109.0	115.5	130.6	210.3
<b>Avg. Power kW</b>	0.230	0.180	0.100	0.083	0.057	0.039	0.029	0.027	0.025	0.022	0.013

**Calculate Attenuation** =  $(0.709140) \cdot \sqrt{\text{FMHz}} + (0.001740) \cdot \text{FMHz}$  (interactive calculator available at <http://www.timesmicrowave/telecom>)  
**Attenuation:** VSWR=1.0 ; Ambient = +25°C (77°F) **Power:** VSWR=1.0; Ambient = +40°C; Inner Conductor = 100°C (212°F);  
 Sea Level; dry air; atmospheric pressure; no solar loading



**Connectors**

Interface	Description	Part Number	Stock Code	VSWR ** Freq. (GHz)	Coupling Nut	Inner Contact Attach	Outer Contact Attach	Finish* Body /Pin	Length in (mm)	Width in (mm)	Weight lb (g)
SMA male	Straight Plug	TC-100-SM	3190-1551	<1.25:1 (<3)	Hex	Solder	Crimp	SS/G	1.0 (25.4)	0.32 (8.1)	0.015 (6.8)
TNC male	Straight Plug	TC-100-TM	3190-1552	<1.25:1 (<3)	Knurl	Solder	Crimp	S/G	1.4 (35.6)	0.59 (15.0)	0.045 (20.4)

\* Finish metals: N=Nickel, S=Silver, G=Gold, SS=Stainless Steel, A=Alballoy \*\*VSWR spec based on 3 foot cable with a connector pair



**Install Tools**

Type	Part Number	Stock Code	Description
Crimp Tool	CT-240/200/195/100	3190-667	Crimp tool for LMR-100, 195, 200 and 240 connectors
Cutting Tool	CCT-01	3190-1544	Cable end flush cut tool
Replacement Blade	RB-01	3190-1609	Replacement blade for cutting tool

