



TNC Male Connector Crimp/Solder Attachment for PE-C240, RG8X, .240 inch, LMR-240, LMR-240-DB, LMR-240-UF, B7808A

RF Connectors Technical Data Sheet

PE44634

Configuration

- TNC Male Connector
- 50 Ohms
- Straight Body Geometry
- Connector Interface Types: PE-C240, RG8X, .240 inch, LMR-240, LMR-240-DB, LMR-240-UF, B7808A

Features

- Max. Operating Frequency 11 GHz
- Gold Plated Brass Contact

Applications

- General Purpose Test
- Custom Cable Assemblies

Description

Pasternack's PE44634 TNC male connector with crimp/solder attachment for PE-C240, RG8X, .240 inch, LMR-240, LMR-240-DB, LMR-240-UF and B7808A is part of our full line of RF components available for same-day shipping. Our TNC male connector operates up to a maximum frequency of 11 GHz.

Our TNC male connector PE44634 datasheet specifications and drawing with dimensions are shown below in this PDF. Pasternack's broad catalog of RF, microwave and millimeter wave connectors allows designers to configure and customize their signal connections however they like. Whether the need is to provide an I/O for a board design, or simply create a custom cable assembly configuration, Pasternack has the right connector for the job. Pasternack can also expertly build your custom cable assemblies for you and ship same-day.

Electrical Specifications

Description	Minimum	Typical	Maximum	Units
Frequency Range	DC		11	GHz
Operating Voltage (AC)			500	Vrms
Dielectric Withstanding Voltage (AC)			1,500	Vrms

Mechanical Specifications

Size	
Length	1.172 in [29.77 mm]
Width/Dia.	0.59 in [14.99 mm]
Weight	0.032 lbs [14.51 g]

Click the following link (or enter part number in "SEARCH" on website) to obtain additional part information including price, inventory and certifications: [TNC Male Connector Crimp/Solder Attachment for PE-C240, RG8X, .240 inch, LMR-240, LMR-240-DB, LMR-240-UF, B7808A PE44634](#)



TNC Male Connector Crimp/Solder Attachment for PE-C240,
RG8X, .240 inch, LMR-240, LMR-240-DB, LMR-240-UF, B7808A

RF Connectors
Technical Data Sheet

PE44634

Material Specifications

Description	Material	Plating
Contact	Brass	Gold
Insulation	POM	
Body	Brass	Nickel

Environmental Specifications

Temperature

Operating Range -40 to +85 deg C

Compliance Certifications (see [product page](#) for current document)

Plotted and Other Data

Notes:

TNC Male Connector Crimp/Solder Attachment for PE-C240, RG8X, .240 inch, LMR-240, LMR-240-DB, LMR-240-UF, B7808A from Pasternack Enterprises has same day shipment for domestic and International orders. Our RF, microwave and millimeter wave products maintain a 99.4% availability and are part of the broadest selection in the industry.

Click the following link (or enter part number in "SEARCH" on website) to obtain additional part information including price, inventory and certifications: [TNC Male Connector Crimp/Solder Attachment for PE-C240, RG8X, .240 inch, LMR-240, LMR-240-DB, LMR-240-UF, B7808A PE44634](#)

URL: <https://www.pasternack.com/tnc-male-standard-rg8x-pe-c240-0.240-connector-pe44634-p.aspx>

The information contained in this document is accurate to the best of our knowledge and representative of the part described herein. It may be necessary to make modifications to the part and/or the documentation of the part, in order to implement improvements. Pasternack reserves the right to make such changes as required. Unless otherwise stated, all specifications are nominal. Pasternack does not make any representation or warranty regarding the suitability of the part described herein for any particular purpose, and Pasternack does not assume any liability arising out of the use of any part or documentation.

PE44634 CAD Drawing

TNC Male Connector Crimp/Solder Attachment for PE-C240, RG8X,
.240 inch, LMR-240, LMR-240-DB, LMR-240-UF, B7808A

REV.	DESCRIPTION	DATE	APPROVED
A	PCR PE44634	12/20/2019	S. ELLIS

REV.	DESCRIPTION	DATE	APPROVED
A	PCR PE44634	12/20/2019	S. ELLIS

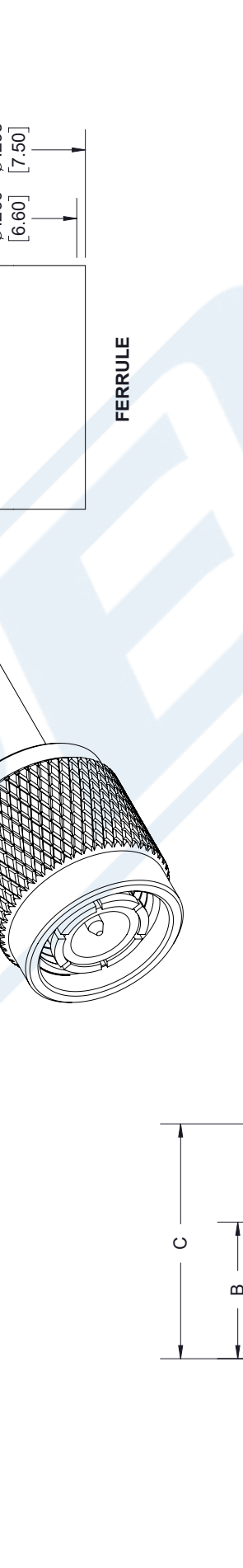
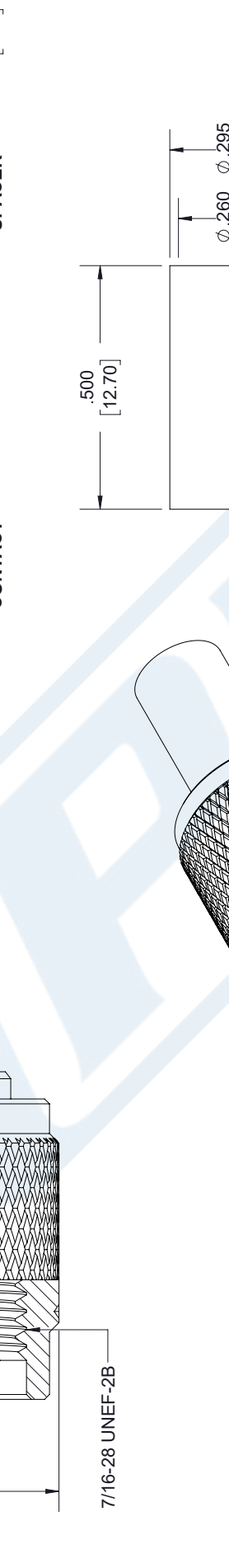
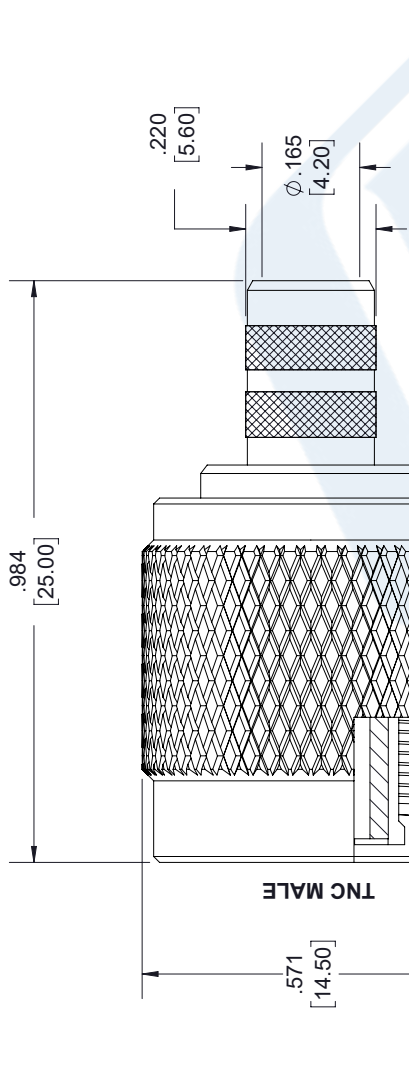
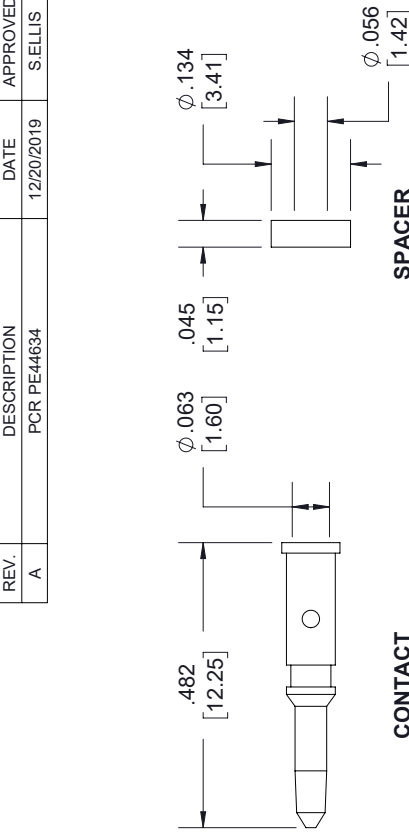

Stripping Dimensions				
Cable Type	A	B	C	Spacer Required
LMR-240 & Similar Coax	.203 [5.15]	.303 [7.70]	.630 [16.00]	Yes
RG8X & Similar Coax	.157 [4.00]	.303 [7.70]	.630 [16.00]	No

UNLESS OTHERWISE SPECIFIED LEADING DIMENSIONS ARE INCHES DIMENSIONS IN [] ARE MILLIMETERS

TOLERANCES:

.X = ± .2	[5.08]	FRACTIONS	± 1/32
.XX = ± .02	[.51]	ANGLES	± 1°
.XXX = ± .005	[.13]	CABLE LENGTH (L)	TOLERANCES:
		L ≤ 12 [305]	= +1 [25] / -0
		12 [305] < L ≤ 60 [1524]	= +2 [51] / -0
		60 [1524] < L ≤ 120 [3048]	= +4 [102] / -0
		120 [3048] < L ≤ 300 [7620]	= +6 [152] / -0
		300 [7620] < L = +5% / L / -0	

ALL DIMENSIONS SHOWN ARE FOR REFERENCE ONLY.

THIRD-ANGLE PROJECTION

THE INFORMATION AND DESIGN IN THIS DOCUMENT IS THE PROPERTY OF PASTERNAK CORPORATION ALL RIGHTS RESERVED.

SHEET 1 OF 1

SCALE N/A

ITEM NO. PE44634

REV A

PE PASTERNAK
an INFINIT brand

Pasternack Enterprises, Inc.
P. O. Box 16759, Irvine, CA 92623.
Phone: 1.949.261.1920 | 1.866.727.8376
Fax: 1.949.261.7451
Website: www.pasternack.com
E-mail: sales@pasternack.com

SIZE | CAGE CODE | DRAWN BY | ITEM NO. | REV

A | 53919 | K.DANG | PE44634 | A



SMA Male Right Angle Connector Crimp/Non-Solder Contact Attachment for LMR-240

RF Connectors Technical Data Sheet



EZ-240-SM-RA-X

Times Microwave Systems Connector Specification

Configuration

- SMA Male Connector
- MIL-STD-348
- 50 Ohms
- Right Angle Body Geometry
- Connector Interface Types: LMR-240
- 5/16 Inch Hex

Features

- Max. Operating Frequency 6 GHz
- Good VSWR of 1.3:1
- Gold Plated Brass/Phosphor Bronze Contact
- 50 µinch contact plating

Applications

- General Purpose Test
- Custom Cable Assemblies

Description

Times Microwave's EZ-240-SM-RA-X SMA male right angle connector offered by Pasternack with crimp/non-solder contact attachment for Times' LMR-240 is part of our full line of RF components available for same-day shipping. Times Microwave's SMA male connector operates up to a maximum frequency of 6 GHz and offers good VSWR of 1.3:1. Its right angle body geometry allows for easier connections in tight spaces.

Times Microwave's SMA male right angle connector EZ-240-SM-RA-X datasheet specifications and drawing with dimensions are shown below in this PDF. Pasternack's broad catalog of RF, microwave and millimeter wave connectors allows designers to configure and customize their signal connections however they like. Whether the need is to provide an I/O for a board design, or simply create a custom cable assembly configuration, Pasternack has the right connector for the job. Pasternack can also expertly build your custom cable assemblies for you and ship same-day.

Electrical Specifications

Description	Minimum	Typical	Maximum	Units
Frequency Range	DC		6	GHz
VSWR			1.3:1	
Insertion Loss			0.25	dB
Dielectric Withstanding Voltage (AC)			1,000	Vrms
Insulation Resistance	5,000			MOhms

Mechanical Specifications

Size

Length	0.725 in [18.42 mm]
Width/Dia.	0.312 in [7.92 mm]
Height	0.88 in [22.35 mm]
Weight	0.021 lbs [9.53 g]

Click the following link (or enter part number in "SEARCH" on website) to obtain additional part information including price, inventory and certifications: [SMA Male Right Angle Connector Crimp/Non-Solder Contact Attachment for LMR-240 EZ-240-SM-RA-X](#)



SMA Male Right Angle Connector Crimp/Non-Solder Contact Attachment for LMR-240

RF Connectors
Technical Data Sheet



EZ-240-SM-RA-X

Mating Cycles 500 Cycles
Mating Torque 7 to 10 in-lbs [0.79 to 1.13 Nm]

Material Specifications

Description	Material	Plating
Contact	Brass/Phosphor Bronze	Gold 50 µinch
Insulation	Teflon	
Body	Brass	Tri-Metal 80 µinch
Coupling Nut	Brass	Tri-Metal 80 µinch

Environmental Specifications

Temperature

Operating Range -40 to +125 deg C
Shock MIL-STD 202G, Meth.213, Cond I
Vibration MIL-STD 202G, Meth.204, Cond D
Thermal Shock MIL-STD 202G, Meth.107, Cond B

Compliance Certifications (see [product page](#) for current document)

Plotted and Other Data

Notes:

Click the following link (or enter part number in "SEARCH" on website) to obtain additional part information including price, inventory and certifications: [SMA Male Right Angle Connector Crimp/Non-Solder Contact Attachment for LMR-240 EZ-240-SM-RA-X](#)



SMA Male Right Angle Connector Crimp/Non-Solder Contact Attachment for LMR-240

RF Connectors Technical Data Sheet



EZ-240-SM-RA-X

SMA Male Right Angle Connector Crimp/Non-Solder Contact Attachment for LMR-240 from Pasternack Enterprises has same day shipment for domestic and International orders. Our RF, microwave and millimeter wave products maintain a 99.4% availability and are part of the broadest selection in the industry.

Click the following link (or enter part number in "SEARCH" on website) to obtain additional part information including price, inventory and certifications: [SMA Male Right Angle Connector Crimp/Non-Solder Contact Attachment for LMR-240 EZ-240-SM-RA-X](https://www.pasternack.com/sma-male-lmr-240-connector-ez-240-sm-ra-x-p.aspx)

URL: <https://www.pasternack.com/sma-male-lmr-240-connector-ez-240-sm-ra-x-p.aspx>

The information contained in this document is accurate to the best of our knowledge and representative of the part described herein. It may be necessary to make modifications to the part and/or the documentation of the part, in order to implement improvements. Pasternack reserves the right to make such changes as required. Unless otherwise stated, all specifications are nominal. Pasternack does not make any representation or warranty regarding the suitability of the part described herein for any particular purpose, and Pasternack does not assume any liability arising out of the use of any part or documentation.

REVISIONS			
REV.	DESCRIPTION	DATE	APPROVED
B	PCR EZ-240-SM-RA-X 20200511	06/15/2020	SRAUTUS

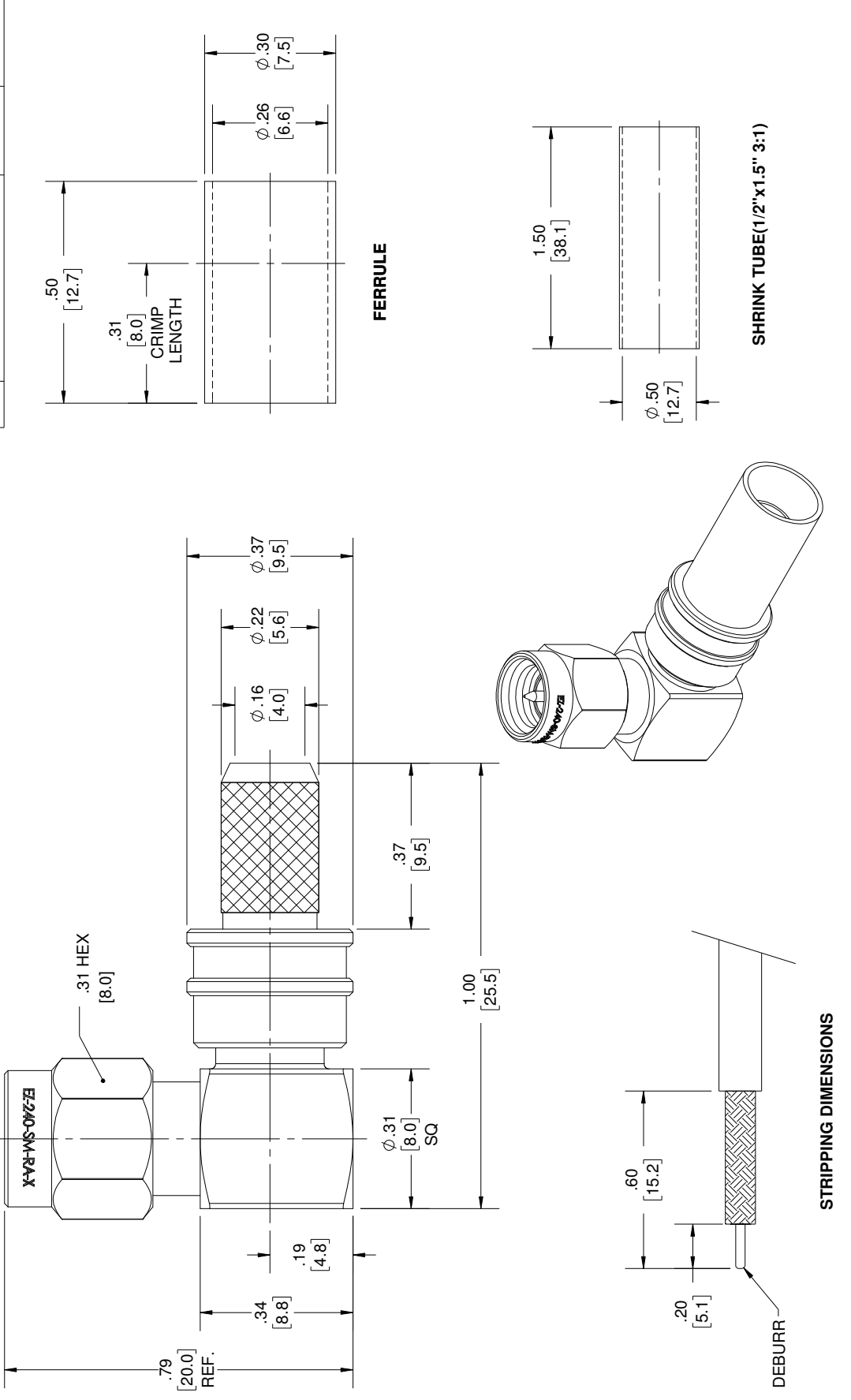

PE PASTERNAK
 an INFINITO brand

Pasternack Enterprises, Inc.
 P.O. Box 16759, Irvine, CA 92623.
 Phone: 1.949.261.1920 | 1.866.727.8376
 Fax: 1.949.261.7451
 Website: www.pasternack.com
 E-mail: sales@pasternack.com

THIRD-ANGLE PROJECTION

THE INFORMATION AND DESIGN IN THIS DOCUMENT IS THE PROPERTY OF PASTERNAK CORPORATION. ALL RIGHTS RESERVED.

SHEET 1 OF 1

SCALE N/A

SIZE	CAGE CODE	DRAWN BY	PART NUMBER
A	53919	K.DANG	EZ-240-SM-RA-X

REV B

UNLESS OTHERWISE SPECIFIED, LEADING DIMENSIONS ARE IN INCHES. DIMENSIONS IN [] ARE MILLIMETERS.

TOLERANCES:

X = +.2 [5.08] FRACTIONS
 XX = ±.02 [.51] ±.1/32
 XXX = ±.005 [.13] ANGLES ± 1°

CABLE LENGTH (L) TOLERANCES:
 L ≤ 12 [305] = +.1 [2.5] / -0
 12 [305] < L ≤ 60 [1524] = +2 [51] / -0
 60 [1524] < L ≤ 120 [3048] = +4 [102] / -0
 120 [3048] < L ≤ 300 [7620] = +6 [152] / -0
 300 [7620] < L = +5%L / -0

ALL DIMENSIONS SHOWN ARE FOR REFERENCE ONLY.

STRIPPING DIMENSIONS

- NOTES:
- CABLE ATTACHMENT:
 - OUTER: CRIMP.
 - INNER: NON-SOLDER.
 - CRIMP SIZE REQUIRED:
 - FERRULE: .255 [6.48] HEX. CRIMP TOOL.

THESE COMMODITIES, TECHNOLOGY OR SOFTWARE WERE EXPORTED FROM THE UNITED STATES IN ACCORDANCE WITH THE EXPORT ADMINISTRATION REGULATIONS. DIVERSION CONTRARY TO U.S. LAW PROHIBITED.

LMR[®]-240-UF UltraFlex Communications Coax

Ideal for...

- Jumper Assemblies in Wireless Communications Systems
- Short Antenna Feeder runs (e.g. WLL, GPS, LMR, Mobile Antennas)
- Any application that requires periodic/repeated flexing



• **LMR[®]- UltraFlex** has a stranded center conductor and rubber outer jacket designed for multiple bending/flexing cycles. It is used for both indoor and outdoor applications.

• **Flexibility** and bendability are hallmarks of the LMR-240-UF cable design. The flexible outer conductor enables the tightest bend radius available for any cable of similar size and performance.

• **Low Loss** is another hallmark feature of LMR-240-UF. Size for size LMR has the lowest loss of any flexible cable and comparable loss to semirigid hard-line cables.

• **RF Shielding** is 50 dB greater than typical single shielded coax (40 dB). The multi-ply bonded foil outer conductor is rated conservatively at > 90 dB (i.e. >180 dB between two adjacent cables).

• **Weatherability:** LMR-240-UF cables are designed for outdoor exposure and have a life expectancy in excess of 10 years.

• **Connectors:** A wide variety of connectors are available for LMR-240-UF cable, including all common interface types, reverse polarity, and solder-on center pins. Most LMR connectors employ crimp outer attachment using standard hex crimp sizes.

• **Cable Assemblies:** All LMR-240-UF cable types are available as pre-terminated cable assemblies. Refer to the section on FlexTech for further details.

Construction Specifications			
Description	Material	In.	(mm)
Inner Conductor	Stranded BC	0.056	(1.42)
Dielectric	Foam Polyethylene	0.150	(3.81)
Outer Conductor	Aluminum Tape	0.155	(3.94)
Overall Braid	Tinned Copper	0.178	(4.52)
Jacket	Black Thermoplastic Elastomer	0.240	(6.10)

Mechanical Specifications			
Performance Property	Units	US	(metric)
Bend Radius: installation	in. (mm)	0.75	(19.1)
Bend Radius: repeated	in. (mm)	2.5	(63.5)
Bending Moment	ft-lb (N-m)	0.125	(0.17)
Weight	lb/ft (kg/m)	0.034	(0.05)
Tensile Strength	lb (kg)	80	(36.3)
Flat Plate Crush	lb/in. (kg/mm)	13	(0.23)

Environmental Specifications		
Performance Property	°F	°C
Installation Temperature Range	-40/+185	-40/+85
Storage Temperature Range	-94/+185	-70/+85
Operating Temperature Range	-40/+185	-40/+85

Electrical Specifications			
Performance Property	Units	US	(metric)
Velocity of Propagation	%	84	
Dielectric Constant	NA	1.42	
Time Delay	nS/ft (nS/m)	1.21	(3.97)
Impedance	ohms	50	
Capacitance	pF/ft (pF/m)	24.2	(79.4)
Inductance	uH/ft (uH/m)	0.060	(0.20)
Shielding Effectiveness	dB	>90	
DC Resistance			
Inner Conductor	ohms/1000ft (/km)	4.28	(14.1)
Outer Conductor	ohms/1000ft (/km)	3.89	(12.8)
Voltage Withstand	Volts DC	1500	
Jacket Spark	Volts RMS	5000	
Peak Power	kW	5.6	

Part Description				
Part Number	Application	Jacket	Color	Stock Code
LMR-240-UF	Indoor/Outdoor	TPE	Black	54041

Attenuation vs. Frequency (typical)

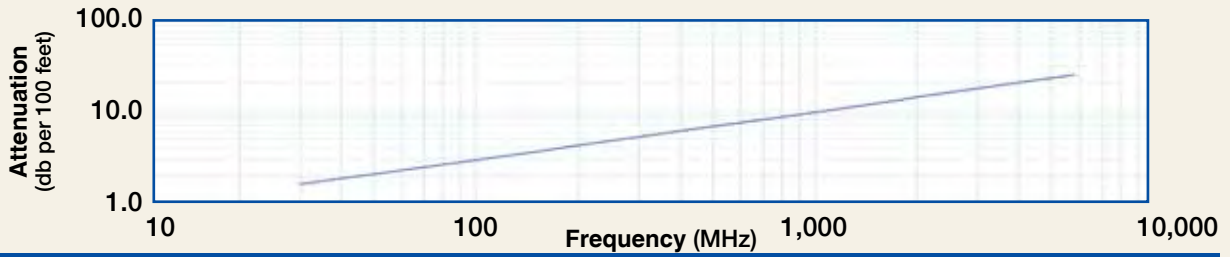

Frequency (MHz)	30	50	150	220	450	900	1500	1800	2000	2500	5800
Attenuation dB/100 ft	1.6	2.1	3.6	4.4	6.3	9.1	11.8	13.0	13.8	15.5	24.4
Attenuation dB/100 m	5.3	6.8	11.9	14.4	20.8	29.8	38.9	42.8	45.2	50.9	80.1
Avg. Power kW	1.24	0.96	0.55	0.45	0.31	0.22	0.17	0.15	0.14	0.13	0.08

Calculate Attenuation = (0.290501) • √FMHz + (0.000396) • FMHz (interactive calculator available at http://www.timesmicrowave.com/cable_calculators)
 Attenuation: VSWR=1.0; Ambient = +25°C (77°F) Power: VSWR=1.0; Ambient = +40°C; Inner Conductor = 100°C (212°F);
 Sea Level; dry air; atmospheric pressure; no solar loading

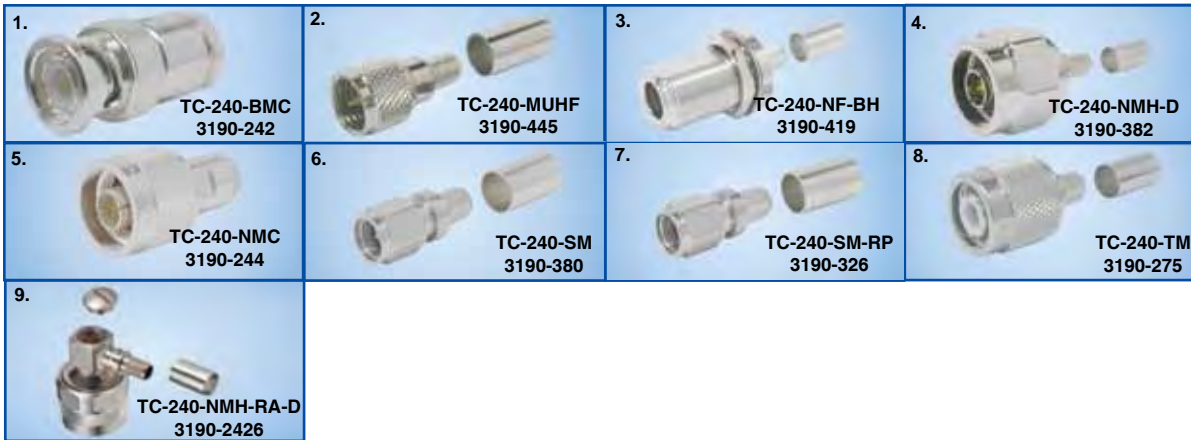

Connectors

Interface	Description	Part Number	Stock Code	VSWR** Freq. (GHz)	Coupling Nut	Inner Contact Attach	Outer Contact Attach	Finish* /Pin	Length in (mm)	Width in (mm)	Weight lb (g)
1. BNC Male	Straight Plug	TC-240-BMC	3190-242	<1.25:1 (2.5)	Knurl	Solder	Clamp	S/G	1.7 (43)	0.56(14.2)	0.040 (18.1)
2. Mini-UHF	Straight Plug	TC-240-MUHF	3190-445	<1.25:1 (2.5)	Knurl	Solder	Crimp	N/G	1.1 (28)	0.45(11.4)	0.014 (6.4)
3. N Female	Bulkhead Jack	TC-240-NF-BH	3190-419	<1.25:1 (2.5)	NA	Solder	Crimp	A/G	1.7 (44)	0.88(22.2)	0.115 (52.2)
4. N Male	Straight Plug	TC-240-NMH-D	3190-382	<1.25:1 (2.5)	Hex	Solder	Crimp	N/S	1.5 (38)	0.75(19.1)	0.086 (39.0)
5. N Male	Straight Plug	TC-240-NMC	3190-244	<1.25:1 (2.5)	Knurl	Solder	Clamp	S/G	1.5 (38)	0.75(19.1)	0.082 (37.2)
6. SMA Male	Straight Plug	TC-240-SM	3190-380	<1.25:1 (10)	Hex	Solder	Crimp	SS/G	1.0 (25)	0.32(8.1)	0.016 (7.3)
7. SMA Male	Reverse Polarity	TC-240-SM-RP	3190-326	<1.25:1 (2.5)	Hex	Solder	Crimp	SS/G	1.0 (25)	0.32(8.1)	0.016 (7.3)
8. TNC Male	Straight Plug	TC-240-TM	3190-275	<1.25:1 (2.5)	Knurl	Solder	Crimp	N/S	1.7 (43)	0.59(15.0)	0.043 (19.5)
9. N Male	Right Angle	TC-240-NMH-RA-D	3190-2426	<1.35:1 (6)	Hex/Knurl	Solder	Crimp	A/G	1.2 (32.4)	1.22 (31.0)	0.091 (41.7)

* Finish metals: N=Nickel, S=Silver, G=Gold, SS=Stainless Steel, A=Alballoy **VSWR spec based on 3 foot cable with a connector pair

Hardware Accessories

Type	Part Number	Stock Code	Description
Ground Kit	GK-S240TT	GK-S240TT	Standard Ground Kit (each)

Install Tools

Type	Part Number	Stock Code	Description
Crimp Tool	CT-240/200/195/100	3190-667	Crimp tool for LMR-100, 195, 200 and 240 connectors
Cutting Tool	CCT-01	3190-1544	Cable end flush cut tool
Replacement Blade	RB-01	3190-1609	Replacement blade for cutting tool

