



SMA Female Connector Crimp/Solder Attachment  
 for PE-C400, PE-B400, PE-B405, LMR-400,  
 LMR-400-DB, LMR-400-UF, 0.400 inch

## RF Connectors Technical Data Sheet

PE44669

### Configuration

- SMA Female Connector
- 50 Ohms
- Straight Body Geometry
- PE-C400, PE-B400, PE-B405, LMR-400, LMR-400-DB, LMR-400-UF, 0.400 inch Interface Type
- Crimp/Solder Attachment

### Features

- Gold Plated Brass Contact

### Applications

- General Purpose Test
- Custom Cable Assemblies

### Description

Pasternack's PE44669 SMA female connector with crimp/solder attachment for PE-C400, PE-B400, PE-B405, LMR-400, LMR-400-DB, LMR-400-UF and 0.400 inch is part of our full line of RF components available for same-day shipping.

Our SMA female connector PE44669 datasheet specifications and drawing with dimensions are shown below in this PDF. Pasternack's broad catalog of RF, microwave and millimeter wave connectors allows designers to configure and customize their signal connections however they like. Whether the need is to provide an I/O for a board design, or simply create a custom cable assembly configuration, Pasternack has the right connector for the job. Pasternack can also expertly build your custom cable assemblies for you and ship same-day.

### Mechanical Specifications

#### Size

Length	1.708 in [43.38 mm]
Width/Dia.	0.71 in [18.03 mm]
Weight	0.068 lbs [30.84 g]

#### Material Specifications

Description	Material	Plating
Contact	Brass	Gold
Insulation	PTFE	
Body	Brass	Gold

Click the following link (or enter part number in "SEARCH" on website) to obtain additional part information including price, inventory and certifications: [SMA Female Connector Crimp/Solder Attachment for PE-C400, PE-B400, PE-B405, LMR-400, LMR-400-DB, LMR-400-UF, 0.400 inch PE44669](#)



SMA Female Connector Crimp/Solder Attachment  
for PE-C400, PE-B400, PE-B405, LMR-400,  
LMR-400-DB, LMR-400-UF, 0.400 inch

RF Connectors Technical Data Sheet

PE44669

**Compliance Certifications** (see [product page](#) for current document)

**Plotted and Other Data**

Notes:

SMA Female Connector Crimp/Solder Attachment for PE-C400, PE-B400, PE-B405, LMR-400, LMR-400-DB, LMR-400-UF, 0.400 inch from Pasternack Enterprises has same day shipment for domestic and International orders. Our RF, microwave and millimeter wave products maintain a 99% availability and are part of the broadest selection in the industry.

Click the following link (or enter part number in "SEARCH" on website) to obtain additional part information including price, inventory and certifications: [SMA Female Connector Crimp/Solder Attachment for PE-C400, PE-B400, PE-B405, LMR-400, LMR-400-DB, LMR-400-UF, 0.400 inch PE44669](#)

URL: <https://www.pasternack.com/sma-female-standard-pe-c400-0.400-connector-pe44669-p.aspx>

The information contained in this document is accurate to the best of our knowledge and representative of the part described herein. It may be necessary to make modifications to the part and/or the documentation of the part, in order to implement improvements. Pasternack reserves the right to make such changes as required. Unless otherwise stated, all specifications are nominal. Pasternack does not make any representation or warranty regarding the suitability of the part described herein for any particular purpose, and Pasternack does not assume any liability arising out of the use of any part or documentation.

# PE44669 CAD Drawing

SMA Female Connector Crimp/Solder Attachment for PE-C400, PE-B400, PE-B405, LMR-400, LMR-400-DB, LMR-400-UF, 0.400 inch

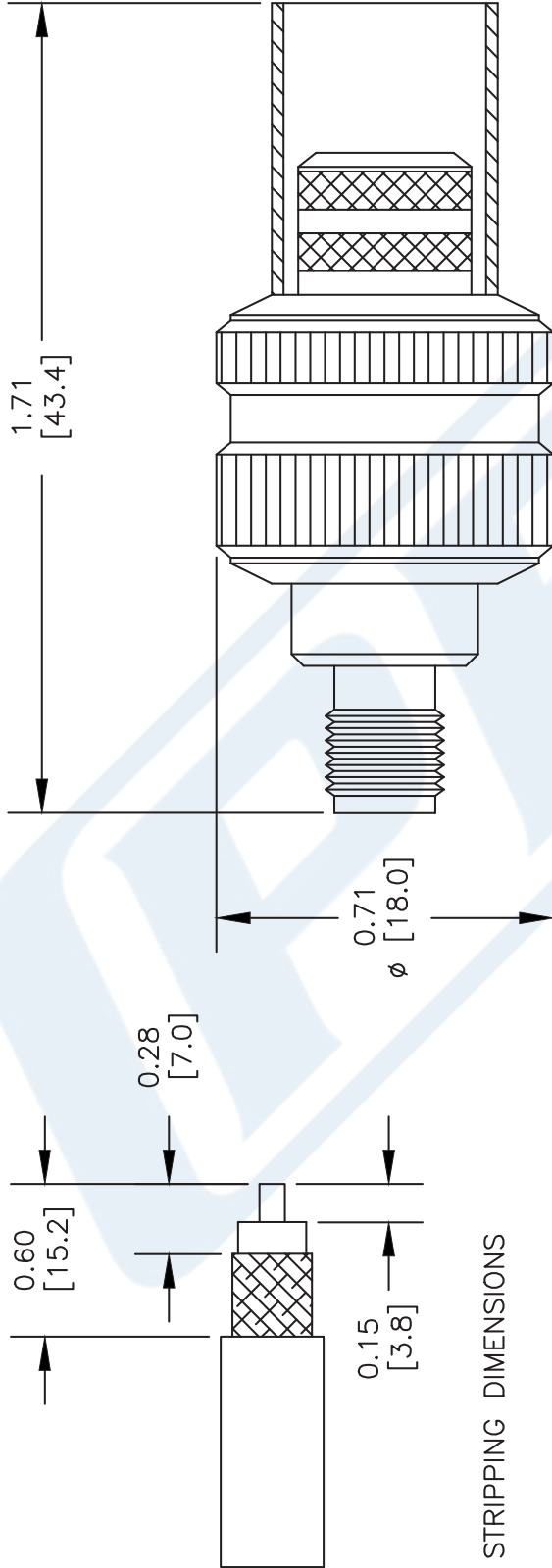

STRIPPING DIMENSIONS

CRIMP SIZE REQUIRED

CONTACT: SOLDER

FERRULE: .429" HEX CRIMP TOOL



**PASTERNAK®**

Pasternack Enterprises, Inc.  
 P.O. Box 16759 | Irvine | CA | 92623  
 Phone: (949) 261-1920 | Fax: (949) 261-7451  
 Website: www.pasternack.com | E-Mail: sales@pasternack.com

DWG TITLE

**PE44669**

NOTES:

1. UNLESS OTHERWISE SPECIFIED ALL DIMENSIONS ARE NOMINAL.
2. ALL SPECIFICATIONS ARE SUBJECT TO CHANGE WITHOUT NOTICE AT ANY TIME.
3. DIMENSIONS ARE IN INCHES [mm].
4. FITS MIL-C-17 AND EQUIVALENT CABLES.

REV. -

FSCM NO. 53919

CAD FILE 102009

SCALE N/A

SIZE A

147

## SMA Right Angle Male Connector Crimp Attachment for LMR-400, LMR-LW400, TCOM-400, LMR-400-LLPX, PE-B400, PE-B405, PE-C400, LMR-400-FR



### PE5129

#### Configuration

- SMA Male Connector
- 50 Ohms
- Right Angle Body Geometry
- Connector Interface Types: LMR-400, LMR-LW400, TCOM-400, LMR-400-LLPX, PE-B400, PE-B405, PE-C400, LMR-400-FR

#### Features

- Max. Operating Frequency 6 GHz
- Gold Plated Brass Contact

#### Applications

- General Purpose Test
- Custom Cable Assemblies

#### Description

Pasternack's PE5129 Right Angle, SMA, Connector is part of our full line of RF components available for same-day shipping. Our Right Angle, SMA male connector operates up to a maximum frequency of 6 GHz. Its right angle body geometry allows for easier connections in tight spaces.

Our SMA male right angle connector PE5129 datasheet specifications and drawing with dimensions are shown below in this PDF. Pasternack's broad catalog of RF, microwave and millimeter wave connectors allows designers to configure and customize their signal connections however they like. Whether the need is to provide an I/O for a board design, or simply create a custom cable assembly configuration, Pasternack has the right connector for the job. Pasternack can also expertly build your custom cable assemblies for you and ship same-day.

#### Electrical Specifications

Description	Minimum	Typical	Maximum	Units
Frequency Range	DC		6	GHz
Insulation Resistance	5,000			MOhms
Impedance		50		Ohms

#### Performance by Frequency

Description	F1	F2	F3	F4	F5	Units
Frequency Range	DC to 3					GHz
VSWR, Max	1.25:1					

#### Mechanical Specifications

##### Size

Length	1.35 in [34.29 mm]
Width	0.91 in [23.11 mm]
Height	0.49 in [12.45 mm]
Weight	0.047 lbs [21.32 g]

SMA Right Angle Male Connector Crimp Attachment  
for LMR-400, LMR-LW400, TCOM-400, LMR-400-  
LLPX, PE-B400, PE-B405, PE-C400, LMR-400-FR



## PE5129

### Material Specifications

Description	Material	Plating
Contact	Brass	Gold
Insulation	PTFE	
Body	Brass	Tri-metal
Gasket	Silicone Rubber	
Crimp Sleeve	Brass	Tri-metal

### Environmental Specifications

**Temperature**

Operating Range -40 to +155 deg C

**Compliance Certifications** (see [product page](#) for current document)

### Plotted and Other Data

Notes:

SMA Right Angle Male Connector Crimp Attachment  
for LMR-400, LMR-LW400, TCOM-400, LMR-400-LLPX, PE-B400, PE-B405, PE-C400, LMR-400-FR



**PE5129**

**Assembly Instruction**

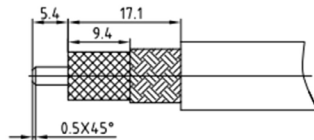
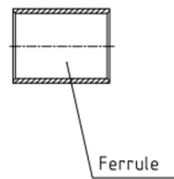
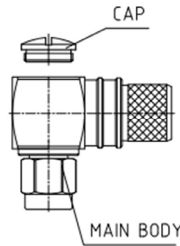

- 1.A. Stripping dimension is as shown by diagram, attention should be paid while stripping.
- B. Remove residual burr.

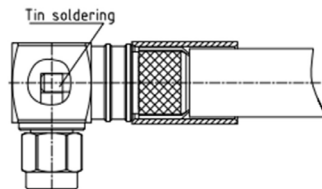

- 2.A. Put the connector in place, Then push the ferrule.
- B. Solder inner conduct.
- C. Remove residual burr.

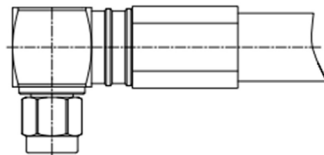

- 3.A. Compression crimping sleeve
- B. Push the heat shrink tube, blow it with heat gun.

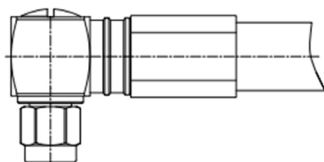

- 3.A. Screw on the end cap.

## SMA Right Angle Male Connector Crimp Attachment for LMR-400, LMR-LW400, TCOM-400, LMR-400-LLPX, PE-B400, PE-B405, PE-C400, LMR-400-FR



### PE5129

SMA Right Angle Male Connector Crimp Attachment for LMR-400, LMR-LW400, TCOM-400, LMR-400-LLPX, PE-B400, PE-B405, PE-C400, LMR-400-FR from Pasternack Enterprises has same day shipment for domestic and International orders. Our RF, microwave and millimeter wave products maintain a 99.4% availability and are part of the broadest selection in the industry.

Click the following link (or enter part number in "SEARCH" on website) to obtain additional part information including price, inventory and certifications: [SMA Right Angle Male Connector Crimp Attachment for LMR-400, LMR-LW400, TCOM-400, LMR-400-LLPX, PE-B400, PE-B405, PE-C400, LMR-400-FR PE5129](https://www.pasternack.com/sma-male-lmr-400-lmr-lw400-lmr-400-llpx-connector-pe5129-p.aspx)

URL: <https://www.pasternack.com/sma-male-lmr-400-lmr-lw400-lmr-400-llpx-connector-pe5129-p.aspx>

The information contained within this document is accurate to the best of our knowledge and representative of the part described herein. It may be necessary to make modifications to the part and/or the documentation of the part in order to implement improvements. Pasternack Enterprises reserves the right to make such changes as required. Unless otherwise stated, all specifications are nominal. Pasternack Enterprises does not make any representation or warranty regarding the suitability of the part described herein for any particular purpose, and Pasternack Enterprises does not assume liability arising out of the use of any part or document.

# PE5129 CAD Drawing

SMA Right Angle Male Connector Crimp Attachment for LMR-400, LMR-LW400, TCOM-400, LMR-400-LLPX, PE-B400, PE-B405, PE-C400, LMR-400-FR

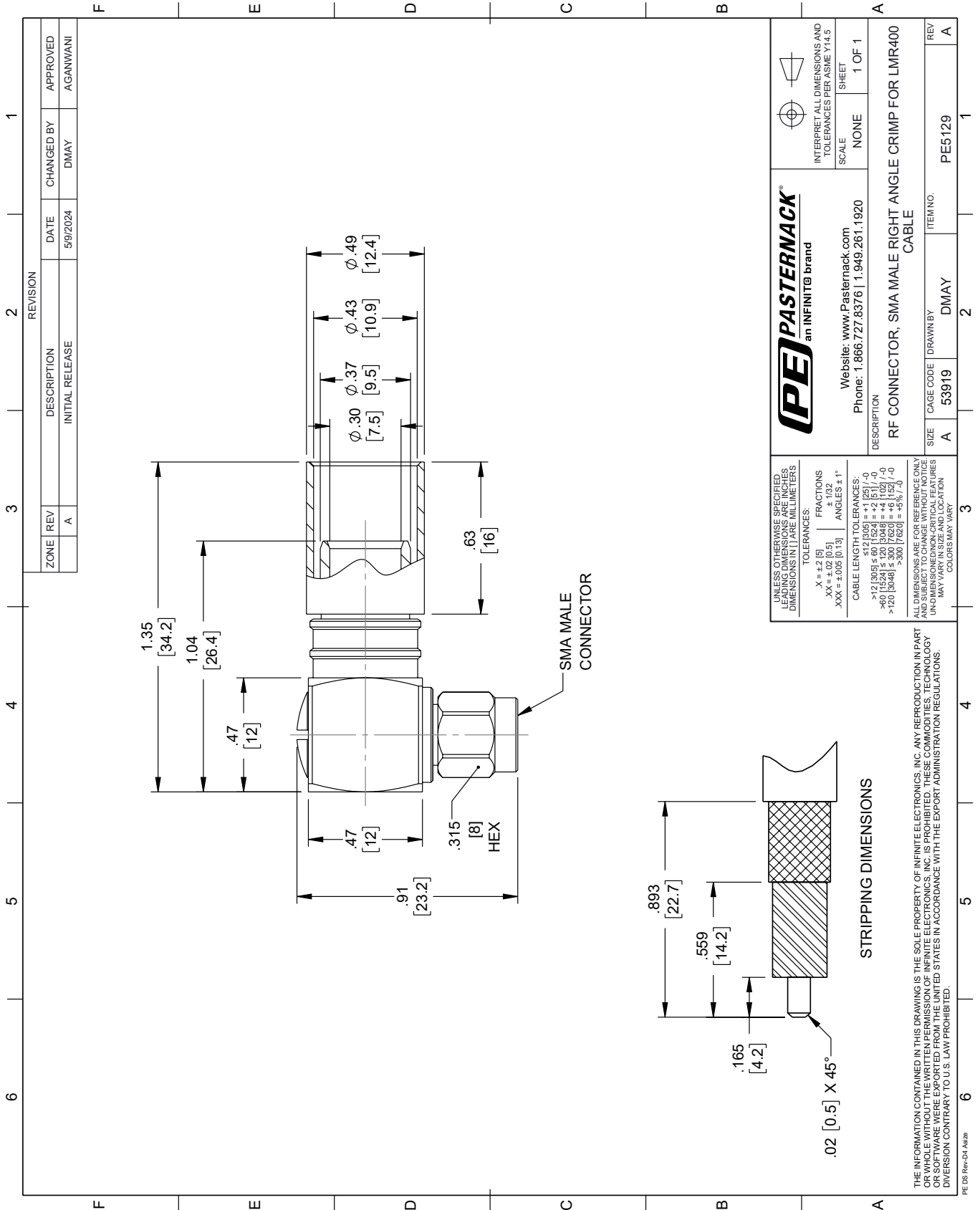

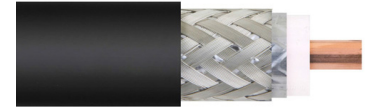

## Low Loss Flexible LMR-400 Outdoor Rated Coax Cable Double Shielded with Black PE Jacket

### RF Cables Technical Data Sheet

#### Times Microwave Systems Coax Cable Specification Configuration

- Low Loss, Outdoor Flexible Cable
- 2 Shield(s)

#### Features

- Flexible Low Loss Communications Coax
- Replacement for Air Dielectric type RG8 cable
- Double Shields provides RF Shielding in excess of 90 db
- Low Loss size for size compared to standard flexible cable

#### Description

Flexible Low Loss Communications Coax Replacement for Air Dielectric type RG8 cable Double Shields provides RF Shielding in excess of 90 db Low Loss size for size compared to standard flexible cable

#### Electrical Specifications

Description	Minimum	Typical	Maximum	Units
Frequency Range	DC		6	GHz
Impedance		50		Ohms
Velocity of Propagation		85		%
Time Delay		1.2 [3.94]		ns/ft [ns/m]
Shielding Effectiveness	90			dB
Dielectric Withstanding Voltage (DC)			2,500	Vdc
Jacket Spark			8,000	Vrms
Inner Conductor DC Resistance			1.39	Ohms/1000ft
Outer Conductor DC Resistance			1.65	Ohms/1000ft
Nominal Capacitance		23.9 [78.41]		pF/ft [pF/m]
Nominal Inductance		0.06 [0.2]		uH/ft [uH/m]
Input Power (Peak)			16	kWatts

Click the following link (or enter part number in "SEARCH" on website) to obtain additional part information including price, inventory and certifications: [Low Loss Flexible LMR-400 Outdoor Rated Coax Cable Double Shielded with Black PE Jacket LMR-400](#)

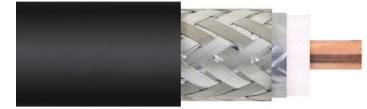

## Low Loss Flexible LMR-400 Outdoor Rated Coax Cable Double Shielded with Black PE Jacket

### RF Cables Technical Data Sheet

#### Performance by Frequency Band

Description	F1	F2	F3	F4	F5	Units
Frequency	50	150	220	450	900	MHz
Attenuation, Typ	0.9	1.5	1.9	2.7	3.9	dB/100ft
	2.95	4.92	6.23	8.86	12.8	dB/100m
Input Power (CW), Max	2,570	1,470	1,200	830	580	Watts

Description	F6	F7	F8	F9	F10	Units
Frequency	1.5	1.8	2	2.5	5.8	GHz
Attenuation, Typ	5.1	5.7	6	6.8	10.8	dB/100ft
	16.73	18.7	19.69	22.31	35.43	dB/100m
Input Power (CW), Max	440	400	370	330	210	Watts

#### Mechanical Specifications

Diameter	0.405 in [10.29 mm]
Weight	0.067 lbs/ft [0.1 kg/m]
Min. Bend Radius (Installation)	1 in [25.4 mm]
Min. Bend Radius (Repeated)	4 in [101.6 mm]
Bending Moment	0.5 lbs-ft [0.68 N-m]
Tensile Strength	160 lbs [72.57 kg]
Flat Plate Crush	40 lbs/in [0.71 kg/mm]

#### Construction Specifications

Description	Material and Plating	Diameter
Inner Conductor	Copper Clad Aluminum, 1 Strand	0.108 in [2.74 mm]
Conductor Type	Solid	
Dielectric	PE (F)	0.285 in [7.24 mm]
First Shield	Aluminum Tape	0.29 in [7.37 mm]
Second Shield	Tinned Copper Braid	0.32 in [8.13 mm]

Click the following link (or enter part number in "SEARCH" on website) to obtain additional part information including price, inventory and certifications: [Low Loss Flexible LMR-400 Outdoor Rated Coax Cable Double Shielded with Black PE Jacket LMR-400](#)

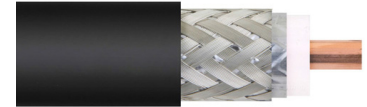

## Low Loss Flexible LMR-400 Outdoor Rated Coax Cable Double Shielded with Black PE Jacket

### RF Cables Technical Data Sheet



**LMR-400**

Jacket	PE, Black	0.405 in [10.29 mm]
--------	-----------	---------------------

#### Environmental Specifications

##### Temperature

Operating Range

-40 to 85 deg C

Storage Range

-70 to 85 deg C

**Compliance Certifications** (see [product page](#) for current document)

#### Plotted and Other Data

Notes:

Low Loss Flexible LMR-400 Outdoor Rated Coax Cable Double Shielded with Black PE Jacket from Pasternack Enterprises has same day shipment for domestic and International orders. Our RF, microwave and millimeter wave products maintain a 99.4% availability and are part of the broadest selection in the industry.

Click the following link (or enter part number in "SEARCH" on website) to obtain additional part information including price, inventory and certifications: [Low Loss Flexible LMR-400 Outdoor Rated Coax Cable Double Shielded with Black PE Jacket LMR-400](#)

URL: <https://www.pasternack.com/50-ohm-low-loss-flexible-lmr400-pe-jacket-double-shielded-black-lmr-400-p.aspx>

The information contained in this document is accurate to the best of our knowledge and representative of the part described herein. It may be necessary to make modifications to the part and/or the documentation of the part, in order to implement improvements. Pasternack reserves the right to make such changes as required. Unless otherwise stated, all specifications are nominal. Pasternack does not make any representation or warranty regarding the suitability of the part described herein for any particular purpose, and Pasternack does not assume any liability arising out of the use of any part or documentation.

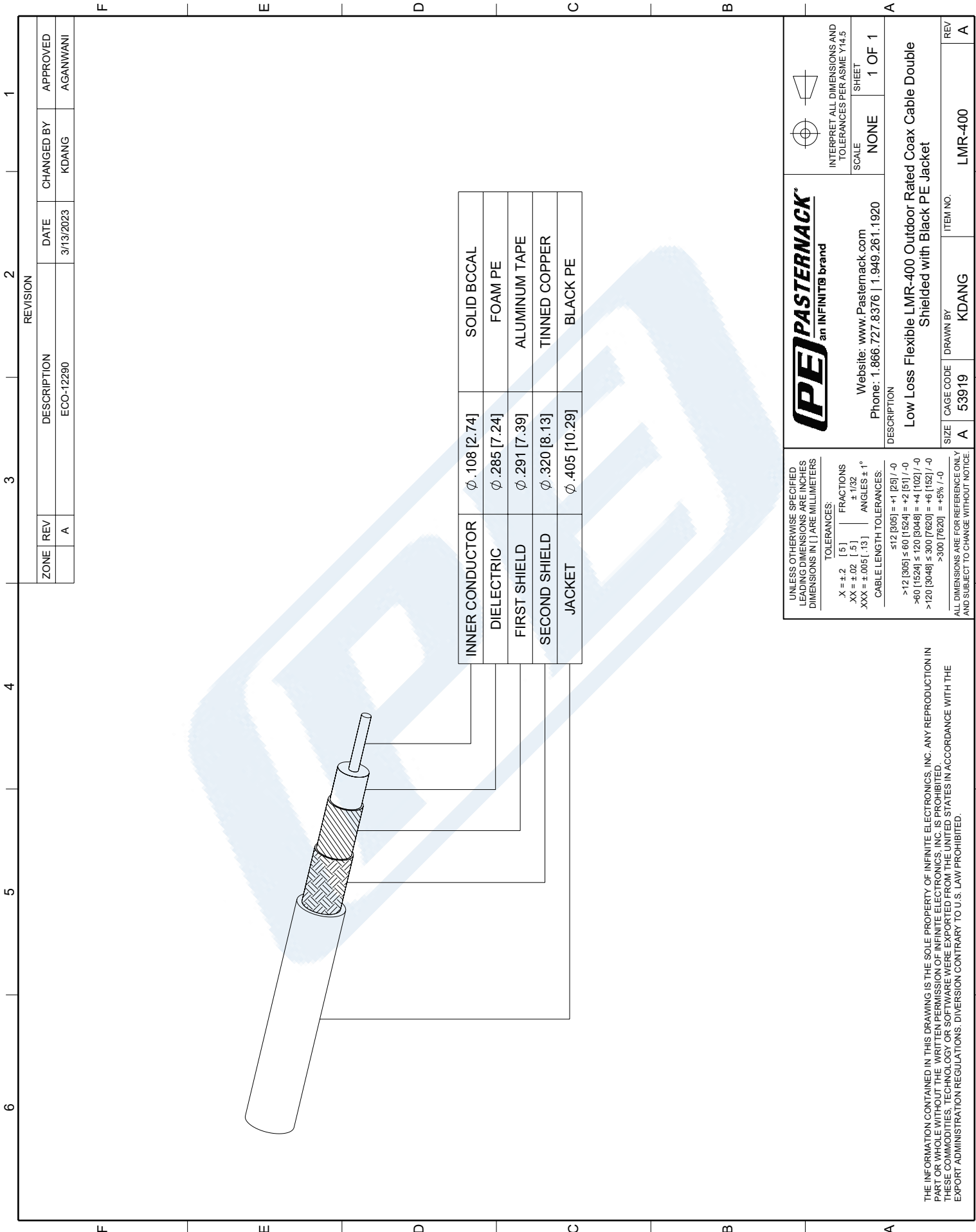

INNER CONDUCTOR	Ø .108 [2.74]	SOLID BCCAL
DIELECTRIC	Ø .285 [7.24]	FOAM PE
FIRST SHIELD	Ø .291 [7.39]	ALUMINUM TAPE
SECOND SHIELD	Ø .320 [8.13]	TINNED COPPER
JACKET	Ø .405 [10.29]	BLACK PE

ZONE		REVISION		DATE		CHANGED BY		APPROVED	
A	REV	ECO-12290	DESCRIPTION	3/13/2023	DATE	KDANG	CHANGED BY	AGANWANI	APPROVED

**(PE) PASTERNAK®**  
an INFINITB brand

Website: [www.Pasternack.com](http://www.Pasternack.com)  
Phone: 1.866.727.8376 | 1.949.261.1920

DESCRIPTION:  
**Low Loss Flexible LMR-400 Outdoor Rated Coax Cable Double Shielded with Black PE Jacket**

SIZE: A    CAGE CODE: 53919    DRAWN BY: KDANG    ITEM NO. LMR-400

INTERPRET ALL DIMENSIONS AND TOLERANCES PER ASME Y14.5

SCALE: NONE    SHEET: 1 OF 1

UNLESS OTHERWISE SPECIFIED LEADING DIMENSIONS ARE INCHES DIMENSIONS IN [ ] ARE MILLIMETERS

TOLERANCES:  
 X = ±.2 [ 5 ]    FRACTIONS ± 1/32  
 .XX = ±.02 [ .5 ]    ANGLES ± 1°  
 .XXX = ±.005 [ .13 ]

CABLE LENGTH TOLERANCES:  
 ≤ 12 [305] = +1 [25] / -0  
 > 12 [305] ≤ 60 [1524] = +2 [51] / -0  
 > 60 [1524] ≤ 120 [3048] = +4 [102] / -0  
 > 120 [3048] ≤ 300 [7620] = +6 [152] / -0  
 > 300 [7620] = +6% / -0

ALL DIMENSIONS ARE FOR REFERENCE ONLY AND SUBJECT TO CHANGE WITHOUT NOTICE.

THE INFORMATION CONTAINED IN THIS DRAWING IS THE SOLE PROPERTY OF INFINITE ELECTRONICS, INC. ANY REPRODUCTION IN PART OR WHOLE WITHOUT THE WRITTEN PERMISSION OF INFINITE ELECTRONICS, INC. IS PROHIBITED. THESE COMMODITIES, TECHNOLOGY OR SOFTWARE WERE EXPORTED FROM THE UNITED STATES IN ACCORDANCE WITH THE EXPORT ADMINISTRATION REGULATIONS. DIVERSION CONTRARY TO U.S. LAW PROHIBITED.