



N Female Connector Crimp/Solder Attachment for PE-C400, PE-B400, PE-B405, LMR-400, LMR-400-DB, LMR-400-UF, 0.400 inch

RF Connectors Technical Data Sheet

PE44534

Configuration

- N Female Connector
- 50 Ohms
- Straight Body Geometry
- PE-C400, PE-B400, PE-B405, LMR-400, LMR-400-DB, LMR-400-UF, 0.400 inch Interface Type
- Crimp/Solder Attachment

Features

- Max. Operating Frequency 11 GHz
- Gold Plated Phosphor Bronze Contact

Applications

- General Purpose Test
- Custom Cable Assemblies

Description

Pasternack's PE44534 type N female connector with crimp/solder attachment for PE-C400, PE-B400, PE-B405, LMR-400, LMR-400-DB, LMR-400-UF and 0.400 inch is part of our full line of RF components available for same-day shipping. Our type N female connector operates up to a maximum frequency of 11 GHz.

Our type N female connector PE44534 datasheet specifications and drawing with dimensions are shown below in this PDF. Pasternack's broad catalog of RF, microwave and millimeter wave connectors allows designers to configure and customize their signal connections however they like. Whether the need is to provide an I/O for a board design, or simply create a custom cable assembly configuration, Pasternack has the right connector for the job. Pasternack can also expertly build your custom cable assemblies for you and ship same-day.

Electrical Specifications

Description	Minimum	Typical	Maximum	Units
Frequency Range	DC		11	GHz

Mechanical Specifications

Size	
Length	1.57 in [39.88 mm]
Width/Dia.	0.67 in [17.02 mm]
Weight	0.071 lbs [32.21 g]

Click the following link (or enter part number in "SEARCH" on website) to obtain additional part information including price, inventory and certifications: [N Female Connector Crimp/Solder Attachment for PE-C400, PE-B400, PE-B405, LMR-400, LMR-400-DB, LMR-400-UF, 0.400 inch PE44534](#)



N Female Connector Crimp/Solder Attachment for PE-C400, PE-B400, PE-B405, LMR-400, LMR-400-DB, LMR-400-UF, 0.400 inch

RF Connectors Technical Data Sheet

PE44534

Material Specifications

Description	Material	Plating
Contact	Phosphor Bronze	Gold
Insulation	PTFE	
Body	Brass	Tri-Metal

Environmental Specifications

Temperature

Operating Range -65 to +165 deg C

Compliance Certifications (see [product page](#) for current document)

Plotted and Other Data

Notes:

N Female Connector Crimp/Solder Attachment for PE-C400, PE-B400, PE-B405, LMR-400, LMR-400-DB, LMR-400-UF, 0.400 inch from Pasternack Enterprises has same day shipment for domestic and International orders. Our RF, microwave and millimeter wave products maintain a 99% availability and are part of the broadest selection in the industry.

Click the following link (or enter part number in "SEARCH" on website) to obtain additional part information including price, inventory and certifications: [N Female Connector Crimp/Solder Attachment for PE-C400, PE-B400, PE-B405, LMR-400, LMR-400-DB, LMR-400-UF, 0.400 inch PE44534](#)

URL: <https://www.pasternack.com/n-female-standard-pe-c400-0.400-connector-pe44534-p.aspx>

The information contained in this document is accurate to the best of our knowledge and representative of the part described herein. It may be necessary to make modifications to the part and/or the documentation of the part, in order to implement improvements. Pasternack reserves the right to make such changes as required. Unless otherwise stated, all specifications are nominal. Pasternack does not make any representation or warranty regarding the suitability of the part described herein for any particular purpose, and Pasternack does not assume any liability arising out of the use of any part or documentation.

PE44534 CAD Drawing

N Female Connector Crimp/Solder Attachment for PE-C400, PE-B400, PE-B405, LMR-400, LMR-400-DB, LMR-400-UF, 0.400 inch



STRIPPING DIMENSIONS

CRIMP SIZES REQUIRED

CONTACT: .118" HEX CRIMP TOOL

FERRULE: .429" HEX CRIMP TOOL

NOTES:
1. UNLESS OTHERWISE SPECIFIED ALL DIMENSIONS ARE NOMINAL.
2. ALL SPECIFICATIONS ARE SUBJECT TO CHANGE WITHOUT NOTICE AT ANY TIME.
3. DIMENSIONS ARE IN INCHES [mm].
4. FITS MIL-C-17 AND EQUIVALENT CABLES.

DWG TITLE
PE44534

REV. B	FSCM NO. 53919	CAD FILE 081811	SCALE N/A	SIZE A	2231
--------	----------------	-----------------	-----------	--------	------

PASTERNAK®
Pasternack Enterprises, Inc.
P.O. Box 16759 | Irvine | CA | 92623

Phone: (949) 261-1920 | Fax: (949) 261-7451
Website: www.pasternack.com | E-Mail: sales@pasternack.com



BNC Male Connector Clamp/Solder Attachment for PE-B400, PE-B405, PE-C400, LMR-400, .400 inch

RF Connectors
Technical Data Sheet

PE4386

Configuration

- BNC Male Connector
- 50 Ohms
- Straight Body Geometry
- PE-B400, PE-B405, PE-C400, LMR-400, .400 inch Interface Type
- Clamp/Solder Attachment

Features

- Gold Plated Brass Contact

Applications

- General Purpose Test
- Custom Cable Assemblies

Description

Pasternack's PE4386 BNC male connector with clamp/solder attachment for PE-B400, PE-B405, PE-C400, LMR-400 and .400 inch is part of our full line of RF components available for same-day shipping.

Our BNC male connector PE4386 datasheet specifications and drawing with dimensions are shown below in this PDF. Pasternack's broad catalog of RF, microwave and millimeter wave connectors allows designers to configure and customize their signal connections however they like. Whether the need is to provide an I/O for a board design, or simply create a custom cable assembly configuration, Pasternack has the right connector for the job. Pasternack can also expertly build your custom cable assemblies for you and ship same-day.

Mechanical Specifications

Size

Length	1.5 in [38.1 mm]
Width/Dia.	0.748 in [19.00 mm]
Weight	0.094 lbs [42.64 g]

Material Specifications

Description	Material	Plating
Contact	Brass	Gold
Insulation	PTFE	
Body	Brass	Nickel
Coupling Nut	Brass	Nickel

Click the following link (or enter part number in "SEARCH" on website) to obtain additional part information including price, inventory and certifications: [BNC Male Connector Clamp/Solder Attachment for PE-B400, PE-B405, PE-C400, LMR-400, .400 inch PE4386](#)



BNC Male Connector Clamp/Solder Attachment for PE-B400, PE-B405, PE-C400, LMR-400, .400 inch

RF Connectors
Technical Data Sheet

PE4386

Environmental Specifications

Compliance Certifications (see [product page](#) for current document)

Plotted and Other Data

Notes:

Click the following link (or enter part number in "SEARCH" on website) to obtain additional part information including price, inventory and certifications: [BNC Male Connector Clamp/Solder Attachment for PE-B400, PE-B405, PE-C400, LMR-400, .400 inch PE4386](#)



BNC Male Connector Clamp/Solder Attachment for PE-B400, PE-B405, PE-C400, LMR-400, .400 inch

Assembly Instruction

ASSEMBLY PROCEDURES

1. SLIDE CLAMP NUT (1), WASHER (2) & GASKET (3) OVER CABLE. STRIP CABLE AS SHOWN. DO NOT NICK BRAID WHILE CUTTING JACKET. TAPER END OF BRAID TO PERMIT ASSEMBLY OF BRAID CLAMP (4). SLIDE BRAID CLAMP (4) OVER BRAID & SEAT AGAINST CABLE.

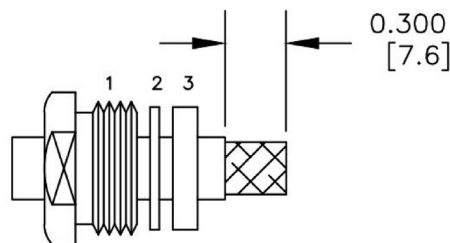

2. FORM BRAID OVER CLAMP NUT (4). TRIM BRAID BACK TO SHOULDER. CUT DIELECTRIC & CENTER CONDUCTOR TO DIMENSION SHOWN. DO NOT NICK CENTER CONDUCTOR. SOLDER CONTACT TO CENTER CONDUCTOR. REMOVE EXCESS SOLDER. DO NOT OVER HEAT DIELECTRIC. INSERT CABLE ASSEMBLY INTO BODY & TIGHTEN.

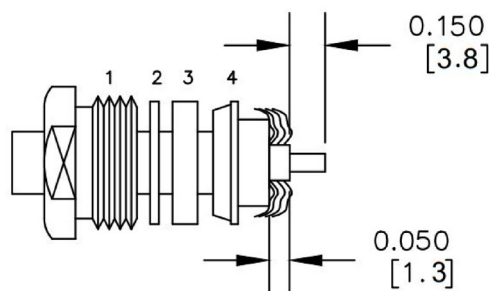

Click the following link (or enter part number in "SEARCH" on website) to obtain additional part information including price, inventory and certifications: [BNC Male Connector Clamp/Solder Attachment for PE-B400, PE-B405, PE-C400, LMR-400, .400 inch PE4386](#)



BNC Male Connector Clamp/Solder Attachment for PE-B400, PE-B405, PE-C400, LMR-400, .400 inch

RF Connectors Technical Data Sheet

PE4386

BNC Male Connector Clamp/Solder Attachment for PE-B400, PE-B405, PE-C400, LMR-400, .400 inch from Pasternack Enterprises has same day shipment for domestic and International orders. Our RF, microwave and millimeter wave products maintain a 99.4% availability and are part of the broadest selection in the industry.

Click the following link (or enter part number in "SEARCH" on website) to obtain additional part information including price, inventory and certifications: [BNC Male Connector Clamp/Solder Attachment for PE-B400, PE-B405, PE-C400, LMR-400, .400 inch PE4386](https://www.pasternack.com/bnc-male-standard-pe-b400-pe-b405-pe-c400-connector-pe4386-p.aspx)

URL: <https://www.pasternack.com/bnc-male-standard-pe-b400-pe-b405-pe-c400-connector-pe4386-p.aspx>

The information contained in this document is accurate to the best of our knowledge and representative of the part described herein. It may be necessary to make modifications to the part and/or the documentation of the part, in order to implement improvements. Pasternack reserves the right to make such changes as required. Unless otherwise stated, all specifications are nominal. Pasternack does not make any representation or warranty regarding the suitability of the part described herein for any particular purpose, and Pasternack does not assume any liability arising out of the use of any part or documentation.

PE4386 CAD Drawing

BNC Male Connector Clamp/Solder Attachment for PE-B400, PE-B405, PE-C400, LMR-400, .400 inch

REV.	DESCRIPTION	DATE	APPROVED
1.2	PCR PE4386 20190111	01/14/19	J.GARCIA

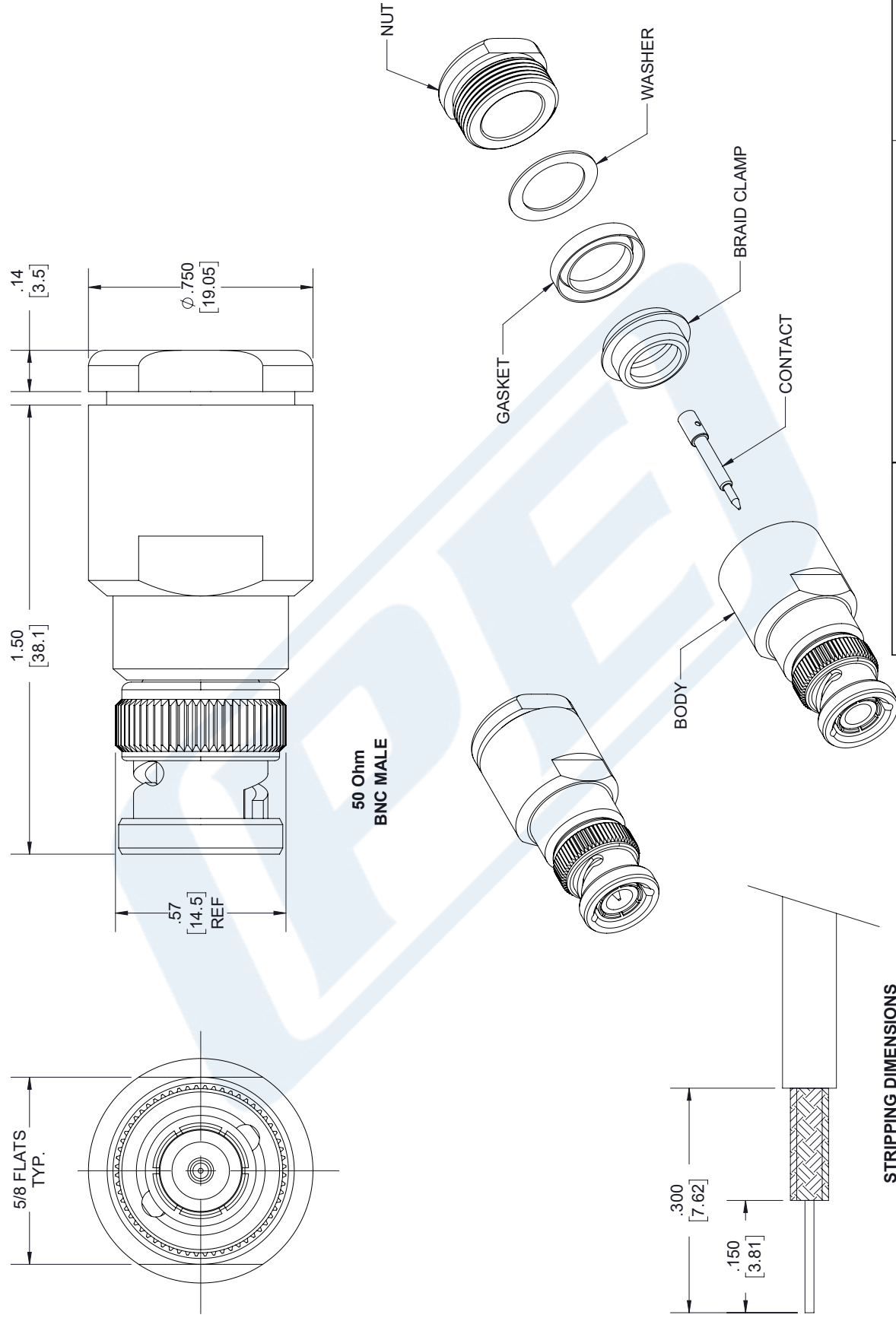

50 Ohm
BNC MALE

UNLESS OTHERWISE SPECIFIED LEADING DIMENSIONS ARE INCHES DIMENSIONS IN [] ARE MILLIMETERS

TOLERANCES:
 X±.2 [5.08] FRACTIONS ±.132
 .XX±.01 [.25] ANGLES ± 1°
 .XXX±.005 [.13] ALL DIMENSIONS SHOWN ARE FOR REFERENCE ONLY.

THIRD-ANGLE PROJECTION

THE INFORMATION AND DESIGN IN THIS DOCUMENT IS THE PROPERTY OF PASTERNAK CORPORATION. ALL RIGHTS RESERVED.

PE PASTERNAK
an INFINITO brand

Pasternack Enterprises, Inc.
 P.O. Box 16759, Irvine, CA 92623.
 Phone: 1.949.261.1920 | 1.866.727.8376
 Fax: 1.949.261.7451
 www.pasternack.com | e-mail: sales@pasternack.com

SHEET 1 OF 1
SCALE N/A

SIZE [CAGE] DRAWN BY PART NUMBER REV
 A 53919 K.Dang PE4386 1.2

- STRIPPING DIMENSIONS**
- NOTES:
- CABLE ATTACHMENT:
 - OUTER: CLAMP.
 - INNER: SOLDER.

THESE COMMODITIES, TECHNOLOGY OR SOFTWARE WERE EXPORTED FROM THE UNITED STATES IN ACCORDANCE WITH THE EXPORT ADMINISTRATION REGULATIONS. DIVERSION CONTRARY TO U.S. LAW PROHIBITED.

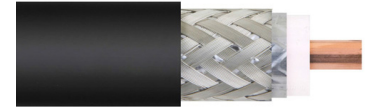

Low Loss Flexible LMR-400 Outdoor Rated Coax Cable Double Shielded with Black PE Jacket

RF Cables Technical Data Sheet

Times Microwave Systems Coax Cable Specification Configuration

- Low Loss, Outdoor Flexible Cable
- 2 Shield(s)

Features

- Flexible Low Loss Communications Coax
- Replacement for Air Dielectric type RG8 cable
- Double Shields provides RF Shielding in excess of 90 db
- Low Loss size for size compared to standard flexible cable

Description

Flexible Low Loss Communications Coax Replacement for Air Dielectric type RG8 cable Double Shields provides RF Shielding in excess of 90 db Low Loss size for size compared to standard flexible cable

Electrical Specifications

Description	Minimum	Typical	Maximum	Units
Frequency Range	DC		6	GHz
Impedance		50		Ohms
Velocity of Propagation		85		%
Time Delay		1.2 [3.94]		ns/ft [ns/m]
Shielding Effectiveness	90			dB
Dielectric Withstanding Voltage (DC)			2,500	Vdc
Jacket Spark			8,000	Vrms
Inner Conductor DC Resistance			1.39	Ohms/1000ft
Outer Conductor DC Resistance			1.65	Ohms/1000ft
Nominal Capacitance		23.9 [78.41]		pF/ft [pF/m]
Nominal Inductance		0.06 [0.2]		uH/ft [uH/m]
Input Power (Peak)			16	kWatts

Click the following link (or enter part number in "SEARCH" on website) to obtain additional part information including price, inventory and certifications: [Low Loss Flexible LMR-400 Outdoor Rated Coax Cable Double Shielded with Black PE Jacket LMR-400](#)

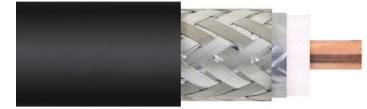

Low Loss Flexible LMR-400 Outdoor Rated Coax Cable Double Shielded with Black PE Jacket

RF Cables Technical Data Sheet

Performance by Frequency Band

Description	F1	F2	F3	F4	F5	Units
Frequency	50	150	220	450	900	MHz
Attenuation, Typ	0.9	1.5	1.9	2.7	3.9	dB/100ft
	2.95	4.92	6.23	8.86	12.8	dB/100m
Input Power (CW), Max	2,570	1,470	1,200	830	580	Watts

Description	F6	F7	F8	F9	F10	Units
Frequency	1.5	1.8	2	2.5	5.8	GHz
Attenuation, Typ	5.1	5.7	6	6.8	10.8	dB/100ft
	16.73	18.7	19.69	22.31	35.43	dB/100m
Input Power (CW), Max	440	400	370	330	210	Watts

Mechanical Specifications

Diameter	0.405 in [10.29 mm]
Weight	0.067 lbs/ft [0.1 kg/m]
Min. Bend Radius (Installation)	1 in [25.4 mm]
Min. Bend Radius (Repeated)	4 in [101.6 mm]
Bending Moment	0.5 lbs-ft [0.68 N-m]
Tensile Strength	160 lbs [72.57 kg]
Flat Plate Crush	40 lbs/in [0.71 kg/mm]

Construction Specifications

Description	Material and Plating	Diameter
Inner Conductor	Copper Clad Aluminum, 1 Strand	0.108 in [2.74 mm]
Conductor Type	Solid	
Dielectric	PE (F)	0.285 in [7.24 mm]
First Shield	Aluminum Tape	0.29 in [7.37 mm]
Second Shield	Tinned Copper Braid	0.32 in [8.13 mm]

Click the following link (or enter part number in "SEARCH" on website) to obtain additional part information including price, inventory and certifications: [Low Loss Flexible LMR-400 Outdoor Rated Coax Cable Double Shielded with Black PE Jacket LMR-400](#)

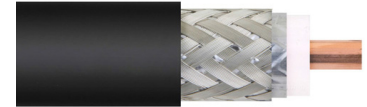

Low Loss Flexible LMR-400 Outdoor Rated Coax
Cable Double Shielded with Black PE Jacket

RF Cables
Technical Data Sheet

Jacket	PE, Black	0.405 in [10.29 mm]
--------	-----------	---------------------

Environmental Specifications

Temperature

Operating Range

-40 to 85 deg C

Storage Range

-70 to 85 deg C

Compliance Certifications (see [product page](#) for current document)

Plotted and Other Data

Notes:

Low Loss Flexible LMR-400 Outdoor Rated Coax Cable Double Shielded with Black PE Jacket from Pasternack Enterprises has same day shipment for domestic and International orders. Our RF, microwave and millimeter wave products maintain a 99.4% availability and are part of the broadest selection in the industry.

Click the following link (or enter part number in "SEARCH" on website) to obtain additional part information including price, inventory and certifications: [Low Loss Flexible LMR-400 Outdoor Rated Coax Cable Double Shielded with Black PE Jacket LMR-400](#)

URL: <https://www.pasternack.com/50-ohm-low-loss-flexible-lmr400-pe-jacket-double-shielded-black-lmr-400-p.aspx>

The information contained in this document is accurate to the best of our knowledge and representative of the part described herein. It may be necessary to make modifications to the part and/or the documentation of the part, in order to implement improvements. Pasternack reserves the right to make such changes as required. Unless otherwise stated, all specifications are nominal. Pasternack does not make any representation or warranty regarding the suitability of the part described herein for any particular purpose, and Pasternack does not assume any liability arising out of the use of any part or documentation.

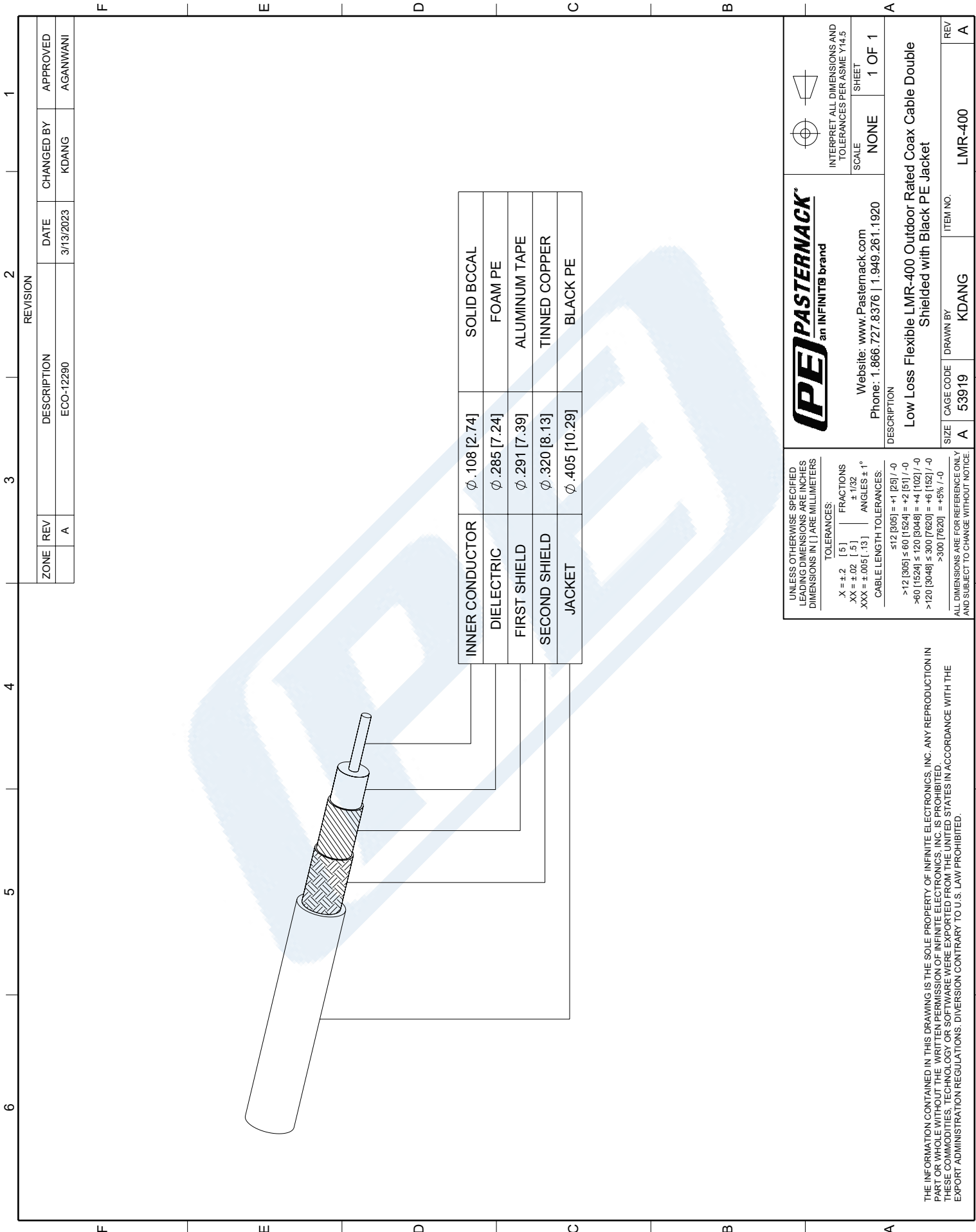

ZONE		REVISION		DATE		CHANGED BY		APPROVED	
A	REV	ECO-12290	DESCRIPTION	3/13/2023	DATE	KDANG	CHANGED BY	AGANWANI	APPROVED

(PE) PASTERNAK®
an INFINITB brand

Website: www.Pasternack.com
 Phone: 1.866.727.8376 | 1.949.261.1920

DESCRIPTION:
Low Loss Flexible LMR-400 Outdoor Rated Coax Cable Double Shielded with Black PE Jacket

SIZE: A CAGE CODE: 53919 DRAWN BY: KDANG ITEM NO.: LMR-400

INTERPRET ALL DIMENSIONS AND TOLERANCES PER ASME Y14.5

SCALE: NONE SHEET: 1 OF 1

UNLESS OTHERWISE SPECIFIED LEADING DIMENSIONS ARE INCHES DIMENSIONS IN [] ARE MILLIMETERS

X = ±.2 [5] FRACTIONS ± 1/32
 .XX = ±.02 [.5] ANGLES ± 1°
 .XXX = ±.005 [.13]

CABLE LENGTH TOLERANCES:
 ≤12 [305] = +1 [25] / -0
 >12 [305] ≤ 60 [1524] = +2 [51] / -0
 >60 [1524] ≤ 120 [3048] = +4 [102] / -0
 >120 [3048] ≤ 300 [7620] = +6 [152] / -0
 >300 [7620] = +6% / -0

ALL DIMENSIONS ARE FOR REFERENCE ONLY AND SUBJECT TO CHANGE WITHOUT NOTICE.

THE INFORMATION CONTAINED IN THIS DRAWING IS THE SOLE PROPERTY OF INFINITE ELECTRONICS, INC. ANY REPRODUCTION IN PART OR WHOLE WITHOUT THE WRITTEN PERMISSION OF INFINITE ELECTRONICS, INC. IS PROHIBITED. THESE COMMODITIES, TECHNOLOGY OR SOFTWARE WERE EXPORTED FROM THE UNITED STATES IN ACCORDANCE WITH THE EXPORT ADMINISTRATION REGULATIONS. DIVERSION CONTRARY TO U.S. LAW PROHIBITED.