

## SMA Right Angle Male Connector Crimp Attachment for LMR-400, LMR-LW400, TCOM-400, LMR-400-LLPX, PE-B400, PE-B405, PE-C400, LMR-400-FR



### PE5129

#### Configuration

- SMA Male Connector
- 50 Ohms
- Right Angle Body Geometry
- Connector Interface Types: LMR-400, LMR-LW400, TCOM-400, LMR-400-LLPX, PE-B400, PE-B405, PE-C400, LMR-400-FR

#### Features

- Max. Operating Frequency 6 GHz
- Gold Plated Brass Contact

#### Applications

- General Purpose Test
- Custom Cable Assemblies

#### Description

Pasternack's PE5129 Right Angle, SMA, Connector is part of our full line of RF components available for same-day shipping. Our Right Angle, SMA male connector operates up to a maximum frequency of 6 GHz. Its right angle body geometry allows for easier connections in tight spaces.

Our SMA male right angle connector PE5129 datasheet specifications and drawing with dimensions are shown below in this PDF. Pasternack's broad catalog of RF, microwave and millimeter wave connectors allows designers to configure and customize their signal connections however they like. Whether the need is to provide an I/O for a board design, or simply create a custom cable assembly configuration, Pasternack has the right connector for the job. Pasternack can also expertly build your custom cable assemblies for you and ship same-day.

#### Electrical Specifications

Description	Minimum	Typical	Maximum	Units
Frequency Range	DC		6	GHz
Insulation Resistance	5,000			MOhms
Impedance		50		Ohms

#### Performance by Frequency

Description	F1	F2	F3	F4	F5	Units
Frequency Range	DC to 3					GHz
VSWR, Max	1.25:1					

#### Mechanical Specifications

##### Size

Length	1.35 in [34.29 mm]
Width	0.91 in [23.11 mm]
Height	0.49 in [12.45 mm]
Weight	0.047 lbs [21.32 g]

SMA Right Angle Male Connector Crimp Attachment for LMR-400, LMR-LW400, TCOM-400, LMR-400-LLPX, PE-B400, PE-B405, PE-C400, LMR-400-FR



## PE5129

### Material Specifications

Description	Material	Plating
Contact	Brass	Gold
Insulation	PTFE	
Body	Brass	Tri-metal
Gasket	Silicone Rubber	
Crimp Sleeve	Brass	Tri-metal

### Environmental Specifications

**Temperature**

Operating Range -40 to +155 deg C

**Compliance Certifications** (see [product page](#) for current document)

### Plotted and Other Data

Notes:

SMA Right Angle Male Connector Crimp Attachment  
for LMR-400, LMR-LW400, TCOM-400, LMR-400-LLPX, PE-B400, PE-B405, PE-C400, LMR-400-FR



**PE5129**

**Assembly Instruction**

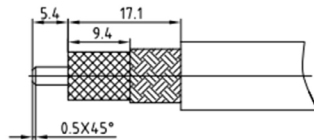
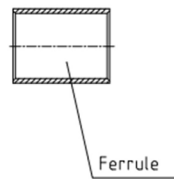
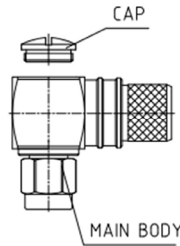

- 1.A. Stripping dimension is as shown by diagram, attention should be paid while stripping.
- B. Remove residual burr.

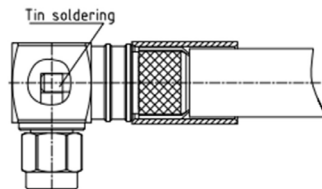

- 2.A. Put the connector in place, Then push the ferrule.
- B. Solder inner conduct.
- C. Remove residual burr.

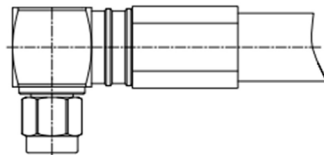

- 3.A. Compression crimping sleeve
- B. Push the heat shrink tube, blow it with heat gun.

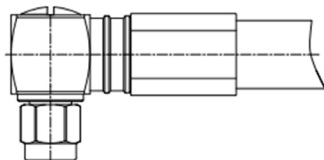

- 3.A. Screw on the end cap.

## SMA Right Angle Male Connector Crimp Attachment for LMR-400, LMR-LW400, TCOM-400, LMR-400-LLPX, PE-B400, PE-B405, PE-C400, LMR-400-FR



### PE5129

SMA Right Angle Male Connector Crimp Attachment for LMR-400, LMR-LW400, TCOM-400, LMR-400-LLPX, PE-B400, PE-B405, PE-C400, LMR-400-FR from Pasternack Enterprises has same day shipment for domestic and International orders. Our RF, microwave and millimeter wave products maintain a 99.4% availability and are part of the broadest selection in the industry.

Click the following link (or enter part number in "SEARCH" on website) to obtain additional part information including price, inventory and certifications: [SMA Right Angle Male Connector Crimp Attachment for LMR-400, LMR-LW400, TCOM-400, LMR-400-LLPX, PE-B400, PE-B405, PE-C400, LMR-400-FR PE5129](https://www.pasternack.com/sma-male-lmr-400-lmr-lw400-lmr-400-llpx-connector-pe5129-p.aspx)

URL: <https://www.pasternack.com/sma-male-lmr-400-lmr-lw400-lmr-400-llpx-connector-pe5129-p.aspx>

The information contained within this document is accurate to the best of our knowledge and representative of the part described herein. It may be necessary to make modifications to the part and/or the documentation of the part in order to implement improvements. Pasternack Enterprises reserves the right to make such changes as required. Unless otherwise stated, all specifications are nominal. Pasternack Enterprises does not make any representation or warranty regarding the suitability of the part described herein for any particular purpose, and Pasternack Enterprises does not assume liability arising out of the use of any part or document.

# PE5129 CAD Drawing

SMA Right Angle Male Connector Crimp Attachment for LMR-400, LMR-LW400, TCOM-400, LMR-400-LLPX, PE-B400, PE-B405, PE-C400, LMR-400-FR

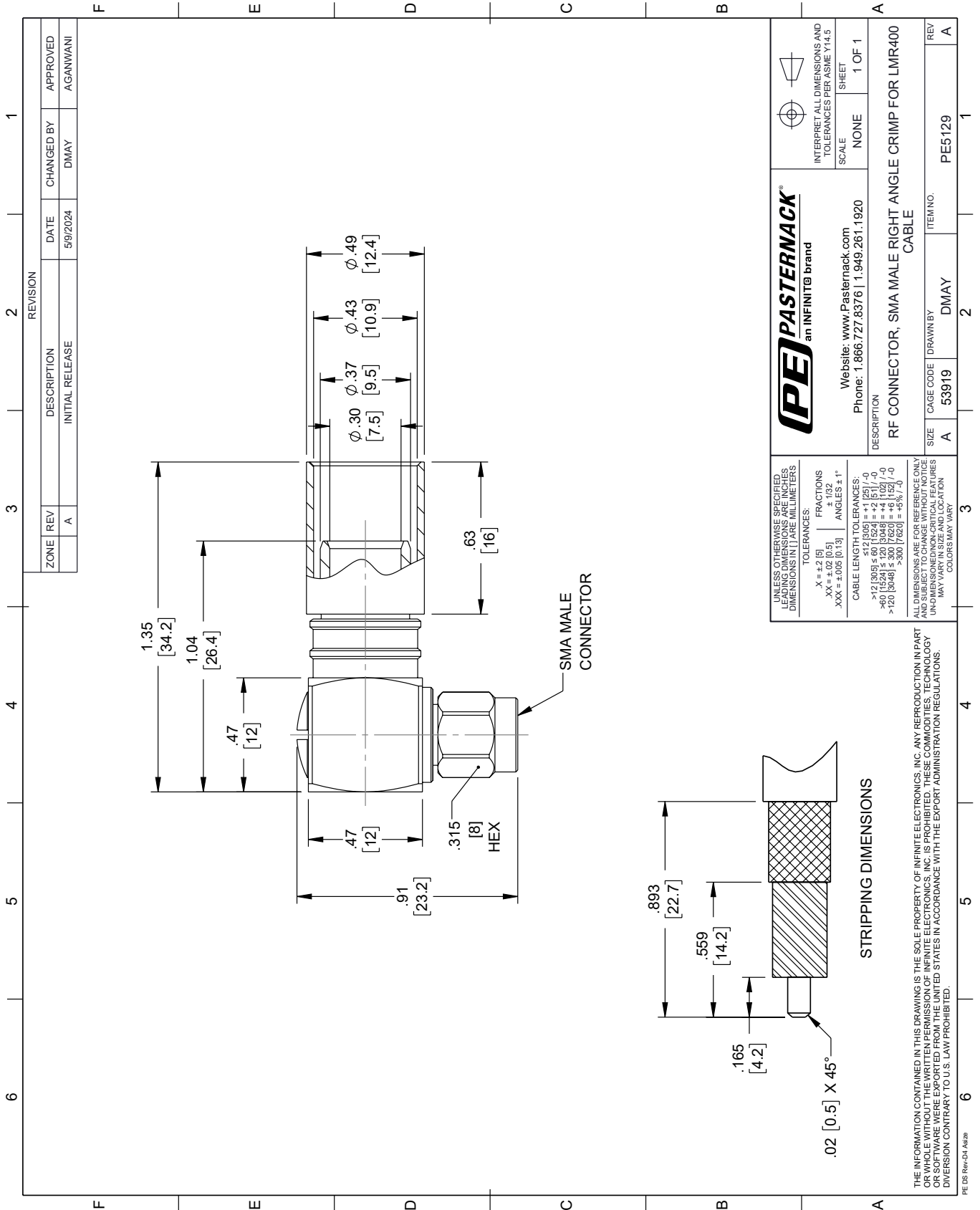

SMA Female Connector Crimp Attachment for LMR400, LMR-400-FR, LMR-LW400, TCOM-400, LMR-400-LLPX, PE-B400, PE-B405, PE-C400, LMR-400-DB



**PE5132**

**Configuration**

- SMA Female Connector
- 50 Ohms
- Connector Interface Types: LMR400, LMR-400-FR, LMR-LW400, TCOM-400, LMR-400-LLPX, PE-B400, PE-B405, PE-C400, LMR-400-DB, LMR-400-UF

**Features**

- Max. Operating Frequency 4 GHz
- Excellent VSWR of 1.25:1
- Gold Plated Beryllium Copper Contact

**Applications**

- General Purpose Test
- Custom Cable Assemblies

**Description**

Pasternack's PE5132, SMA, Connector is part of our full line of RF components available for same-day shipping. Our SMA female connector operates up to a maximum frequency of 4 GHz and offers excellent VSWR of 1.25:1.

Our SMA female connector PE5132 datasheet specifications and drawing with dimensions are shown below in this PDF. Pasternack's broad catalog of RF, microwave and millimeter wave connectors allows designers to configure and customize their signal connections however they like. Whether the need is to provide an I/O for a board design, or simply create a custom cable assembly configuration, Pasternack has the right connector for the job. Pasternack can also expertly build your custom cable assemblies for you and ship same-day.

**Electrical Specifications**

Description	Minimum	Typical	Maximum	Units
Frequency Range	DC		4	GHz
VSWR			1.25:1	
Insulation Resistance	5,000			MOhms
Impedance		50		Ohms

**Mechanical Specifications**

**Size**

Length	1.42 in [36.07 mm]
Width	0.5 in [12.70 mm]
Height	0.5 in [12.7 mm]
Weight	0.034 lbs [15.42 g]

**Material Specifications**

Description	Material	Plating
Contact	Beryllium Copper	Gold
Insulation	PTFE	
Body	Brass	Tri-metal
Crimp Sleeve	Brass	Tri-metal

SMA Female Connector Crimp Attachment for LMR400,  
LMR-400-FR, LMR-LW400, TCOM-400, LMR-400-  
LLPX, PE-B400, PE-B405, PE-C400, LMR-400-DB



## PE5132

---

### Environmental Specifications

**Temperature**

Operating Range

-40 to +155 deg C

**Compliance Certifications** (see [product page](#) for current document)

### Plotted and Other Data

Notes:

SMA Female Connector Crimp Attachment for LMR400,  
LMR-400-FR, LMR-LW400, TCOM-400, LMR-400-  
LLPX, PE-B400, PE-B405, PE-C400, LMR-400-DB



## PE5132

### Assembly Instruction

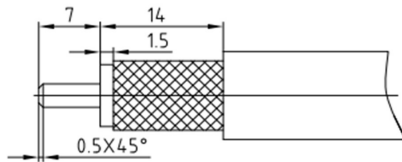
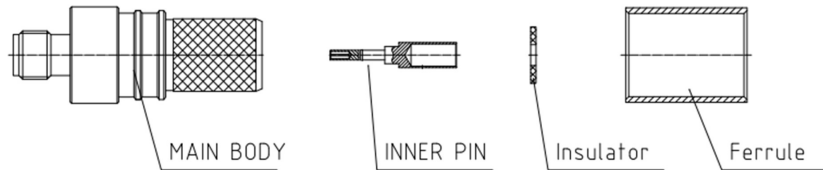

- 1.A. Stripping dimension is as shown by diagram, attention should be paid while stripping.
- B. Remove residual burr.

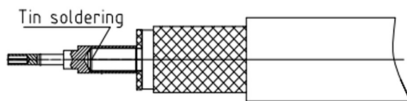

- 2.A. Solder inner conduct.
- B. Remove residual burr.

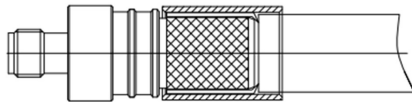

3. Put the connector in place, Then push the ferrule.



- 4.A. Compression crimping sleeve
- B. Push the heat shrink tube, blow it with heat gun.

SMA Female Connector Crimp Attachment for LMR400, LMR-400-FR, LMR-LW400, TCOM-400, LMR-400-LLPX, PE-B400, PE-B405, PE-C400, LMR-400-DB



## PE5132

SMA Female Connector Crimp Attachment for LMR400, LMR-400-FR, LMR-LW400, TCOM-400, LMR-400-LLPX, PE-B400, PE-B405, PE-C400, LMR-400-DB from Pasternack Enterprises has same day shipment for domestic and International orders. Our RF, microwave and millimeter wave products maintain a 99.4% availability and are part of the broadest selection in the industry.

Click the following link (or enter part number in "SEARCH" on website) to obtain additional part information including price, inventory and certifications: [SMA Female Connector Crimp Attachment for LMR400, LMR-400-FR, LMR-LW400, TCOM-400, LMR-400-LLPX, PE-B400, PE-B405, PE-C400, LMR-400-DB PE5132](#)

URL: <https://www.pasternack.com/sma-female-lmr400-lmr-400-fr-tcom-400-connector-pe5132-p.aspx>

The information contained within this document is accurate to the best of our knowledge and representative of the part described herein. It may be necessary to make modifications to the part and/or the documentation of the part in order to implement improvements. Pasternack Enterprises reserves the right to make such changes as required. Unless otherwise stated, all specifications are nominal. Pasternack Enterprises does not make any representation or warranty regarding the suitability of the part described herein for any particular purpose, and Pasternack Enterprises does not assume liability arising out of the use of any part or document.

# PE5132 CAD Drawing

SMA Female Connector Crimp Attachment for LMR400, LMR-400-FR, LMR-LW400, TCOM-400, LMR-400-LLPX, PE-B400, PE-B405, PE-C400, LMR-400-DB

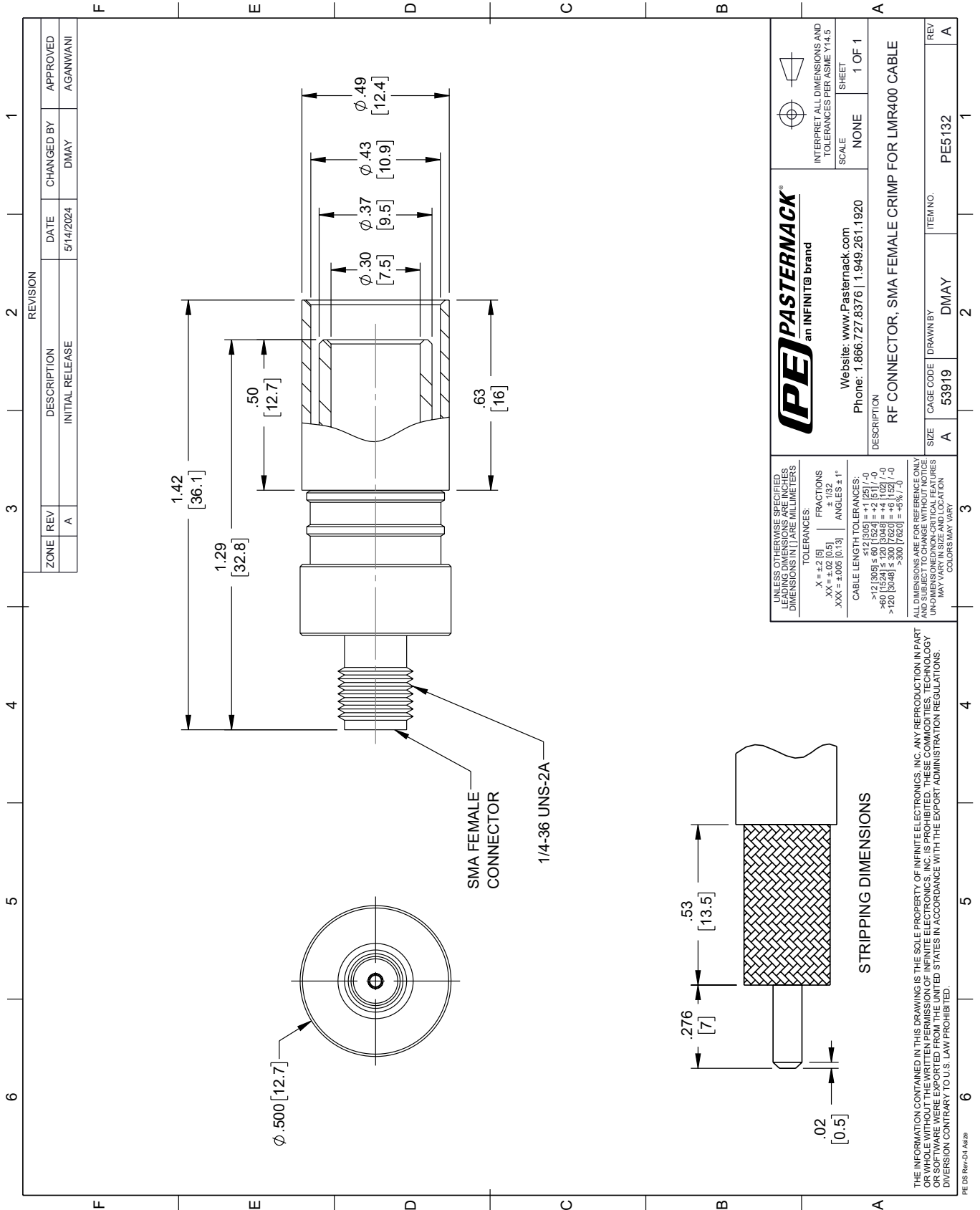



## Low PIM Flexible TCOM-400 Coax Cable Double Shielded with Black PE Jacket

### RF Cables Technical Data Sheet

## Times Microwave Systems Coax Cable Specification

### Configuration

- Low PIM Flexible Cable
- 2 Shield(s)

### Description

TCOM-400 part number from Pasternack is a low PIM coax cable that is flexible. Pasternack flexible coax RF cable has an impedance of 50 Ohm and a Foam PE dielectric. Our TCOM-400 coax cable is constructed with a 0.405-inch jacket made of polyethylene. This coaxial cable has a dielectric withstanding voltage of 2500 Vdc.

The TCOM-400 flexible RF cable has a shield count of 2 and RF shielding of 100 dB. Our coax cable from Pasternack has a maximum frequency of 10 GHz. The maximum passive intermodulation of this low PIM cable is -155 dBc. Additional specifications for this TCOM-400 double-shielded RF coaxial cable are on our downloadable PDF datasheet above.

Our TCOM-400 coax cable can operate at temperatures ranging from -40 to 85 degrees C. This black-colored flexible RF cable with a 50 Ohm impedance has a typical insertion loss/maximum attenuation of 15.7 dB/100ft at a frequency of 10 GHz. The TCOM-400 flexible RF cable has a solid copper clad aluminum center conductor. This coaxial cable features a dual shield of tinned copper braid over the silver plated copper braid.

Pasternack TCOM-400 low PIM coax cables are part of over 40,000 RF, microwave, and millimeter wave components. These flexible cables and our other RF parts are available for same-day shipping worldwide. Custom RF cable assemblies using TCOM-400 or other coax can be built and shipped the same business day as well.

### Electrical Specifications

Description	Minimum	Typical	Maximum	Units
Frequency Range	DC		10	GHz
Impedance		50		Ohms
Velocity of Propagation		85		%
Time Delay		1.2 [3.94]		ns/ft [ns/m]
Shielding Effectiveness	100			dB
Passive Intermodulation			-155	dBc
Dielectric Withstanding Voltage (DC)			2,500	Vdc
Jacket Spark			8,000	Vrms
Inner Conductor DC Resistance			1.39	Ohms/1000ft
Outer Conductor DC Resistance			1.47	Ohms/1000ft
Nominal Capacitance		23.9 [78.41]		pF/ft [pF/m]
Nominal Inductance		0.06 [0.2]		uH/ft [uH/m]
Input Power (Peak)			16	kWatts

Click the following link (or enter part number in "SEARCH" on website) to obtain additional part information including price, inventory and certifications: [Low PIM Flexible TCOM-400 Coax Cable Double Shielded with Black PE Jacket TCOM-400](#)



## Low PIM Flexible TCOM-400 Coax Cable Double Shielded with Black PE Jacket

### RF Cables Technical Data Sheet



#### Performance by Frequency Band

Description	F1	F2	F3	F4	F5	Units
Frequency	0.15	0.22	0.45	0.9	1.5	GHz
Attenuation, Typ	1.6	2	2.9	4.2	5.4	dB/100ft
	5.25	6.56	9.51	13.78	17.72	dB/100m
Input Power (CW), Max	1,380	1,130	780	540	410	Watts

Description	F6	F7	F8	F9	F10	Units
Frequency	1.8	2	2.5	5.8	10	GHz
Attenuation, Typ	6	6.4	7.2	11.5	15.7	dB/100ft
	19.69	21	23.62	37.73	51.51	dB/100m
Input Power (CW), Max	370	350	310	190	140	Watts

#### Mechanical Specifications

Diameter	0.405 in [10.29 mm]
Weight	0.08 lbs/ft [0.12 kg/m]
Min. Bend Radius (Installation)	1 in [25.4 mm]
Min. Bend Radius (Repeated)	4 in [101.6 mm]
Bending Moment	0.5 lbs-ft [0.68 N-m]
Tensile Strength	160 lbs [72.57 kg]
Flat Plate Crush	40 lbs/in [0.71 kg/mm]

#### Construction Specifications

Description	Material and Plating	Diameter
Inner Conductor	Copper Clad Aluminum, 1 Strand	0.108 in [2.74 mm]
Conductor Type	Solid	
Dielectric	PE (F)	0.285 in [7.24 mm]
First Shield	Silver Plated Copper Braid	0.295 in [7.49 mm]

Click the following link (or enter part number in "SEARCH" on website) to obtain additional part information including price, inventory and certifications: [Low PIM Flexible TCOM-400 Coax Cable Double Shielded with Black PE Jacket TCOM-400](#)



Low PIM Flexible TCOM-400 Coax Cable  
Double Shielded with Black PE Jacket

**RF Cables**  
**Technical Data Sheet**

Second Shield	Tinned Copper Braid	0.33 in [8.38 mm]
Jacket	PE, Black	0.405 in [10.29 mm]

**Environmental Specifications**

**Temperature**

Operating Range	-40 to +85 deg C
Installation Range	-40 to +85 deg C
Storage Range	-70 to +85 deg C

**Compliance Certifications** (see [product page](#) for current document)

**Plotted and Other Data**

Notes:

Low PIM Flexible TCOM-400 Coax Cable Double Shielded with Black PE Jacket from Pasternack Enterprises has same day shipment for domestic and International orders. Our RF, microwave and millimeter wave products maintain a 99.4% availability and are part of the broadest selection in the industry.

Click the following link (or enter part number in "SEARCH" on website) to obtain additional part information including price, inventory and certifications: [Low PIM Flexible TCOM-400 Coax Cable Double Shielded with Black PE Jacket TCOM-400](#)

URL: <https://www.pasternack.com/low-pim-flexible-tcom400-pe-jacket-silver-plated-copper-braid-over-tinned-copper-braid-outer-conductor-double-shielded-tcom-400-p.aspx>

The information contained in this document is accurate to the best of our knowledge and representative of the part described herein. It may be necessary to make modifications to the part and/or the documentation of the part, in order to implement improvements. Pasternack reserves the right to make such changes as required. Unless otherwise stated, all specifications are nominal. Pasternack does not make any representation or warranty regarding the suitability of the part described herein for any particular purpose, and Pasternack does not assume any liability arising out of the use of any part or documentation.

REVISION			
ZONE	REV	DESCRIPTION	DATE
	A	INITIAL RELEASE	3/20/2023
		CHANGED BY	AGANWANI
		KDANG	

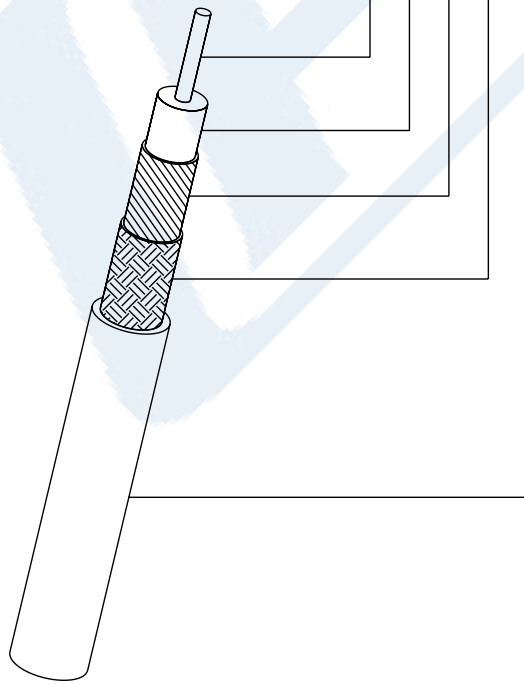

Inner Conductor	Ø .108 [2.74]	Solid BCCAI
Dielectric	Ø .285 [7.24]	Foam PE (Polyethylene)
First Shield	Ø .295 [7.49]	SPC Strip Braid
Second Shield	Ø .330 [8.38]	TC Braid Over Al Tape
Jacket	Ø .405 [10.29]	Black PE (Polyethylene)

UNLESS OTHERWISE SPECIFIED LEADING DIMENSIONS ARE INCHES DIMENSIONS IN [ ] ARE MILLIMETERS

TOLERANCES:  
 .X = ±.2 [ .5 ] FRACTIONS  
 .XX = ±.02 [ .5 ] ± 1/32  
 .XXX = ±.005 [ .13 ] ANGLES ± 1°

CABLE LENGTH TOLERANCES:  
 ≤12 [305] = +1 [25] / -0  
 >12 [305] ≤ 60 [1524] = +2 [51] / -0  
 >60 [1524] ≤ 120 [3048] = +4 [102] / -0  
 >120 [3048] ≤ 300 [7620] = +6 [152] / -0  
 >300 [7620] = +5% / -0

ALL DIMENSIONS ARE FOR REFERENCE ONLY AND SUBJECT TO CHANGE WITHOUT NOTICE



Website: [www.Pasternack.com](http://www.Pasternack.com)  
 Phone: 1.866.727.8376 | 1.949.261.1920

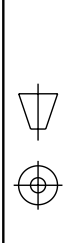

INTERPRET ALL DIMENSIONS AND TOLERANCES PER ASME Y14.5  
 SCALE NONE  
 SHEET 1 OF 1

DESCRIPTION  
**Low PIM Flexible TCOM-400 Rated Coax Cable Double Shielded with Black PE Jacket**

ITEM NO. TCOM-400  
 DRAWN BY KDANG  
 CABLE CODE A 53919  
 REV A

THE INFORMATION CONTAINED IN THIS DRAWING IS THE SOLE PROPERTY OF INFINITE ELECTRONICS, INC. ANY REPRODUCTION IN PART OR WHOLE WITHOUT THE WRITTEN PERMISSION OF INFINITE ELECTRONICS, INC. IS PROHIBITED. THESE COMMODITIES, TECHNOLOGY OR SOFTWARE WERE EXPORTED FROM THE UNITED STATES IN ACCORDANCE WITH THE EXPORT ADMINISTRATION REGULATIONS. DIVERSION CONTRARY TO U.S. LAW PROHIBITED.