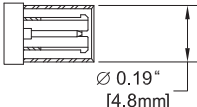
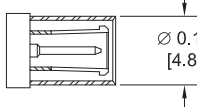
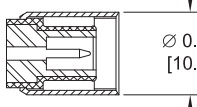
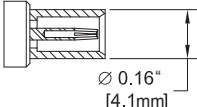
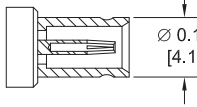
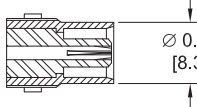
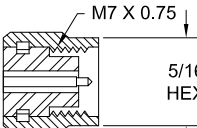
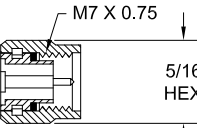
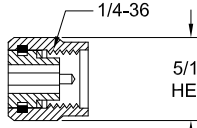
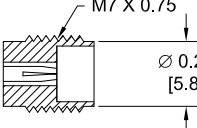
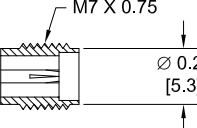
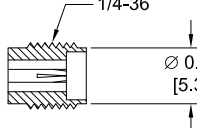
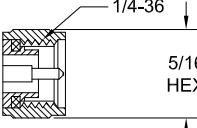
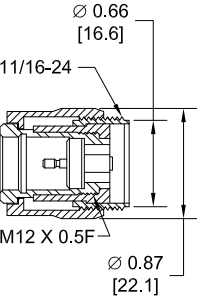
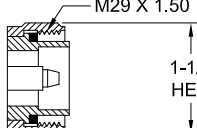
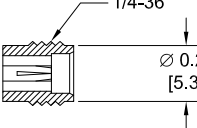
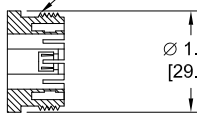
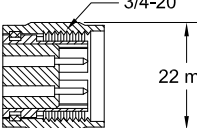
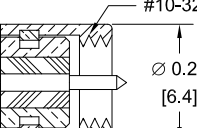
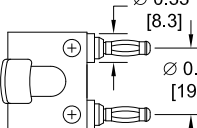
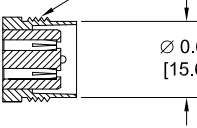
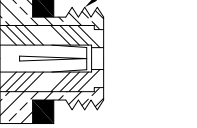
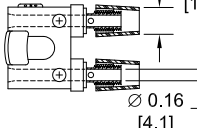
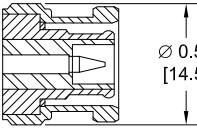
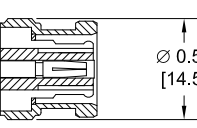
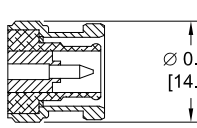
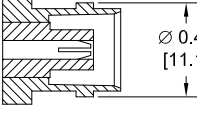
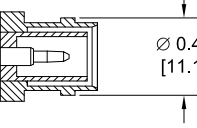
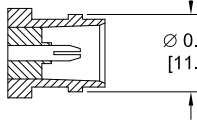

コネクタ識別図

仕様は、コネクタを識別する目的のみの記載です。

1.0/2.3 SLIDE ON	PLUG	 ∅ 0.19" [4.8mm]	1.0/2.3 SNAP ON	PLUG	 ∅ 0.19" [4.8mm]	1.6/5.6	PLUG	 ∅ 0.43" [10.8mm]
	JACK	 ∅ 0.16" [4.1mm]		JACK	 ∅ 0.16" [4.1mm]		JACK	 ∅ 0.33" [8.3mm]
1.85 mm**	MALE	 M7 X 0.75 5/16 HEX	2.4 mm**	MALE	 M7 X 0.75 5/16 HEX	2.92 mm*	MALE	 1/4-36 5/16 HEX
	FEMALE	 M7 X 0.75 ∅ 0.23 [5.8]		FEMALE	 M7 X 0.75 ∅ 0.21 [5.3]		FEMALE	 1/4-36 ∅ 0.21 [5.3]
3.5 mm*	MALE	 1/4-36 5/16 HEX	7 mm	 ∅ 0.66 [16.6] 11/16-24 M12 X 0.5F ∅ 0.87 [22.1]	7/16	PLUG	 M29 X 1.50 1-1/4 HEX	
	FEMALE	 1/4-36 ∅ 0.21 [5.3]		JACK		 M29 X 1.50 ∅ 1.14 [29.0]		
3/4-20 TWINAX	MALE	 3/4-20 22 mm	10-32	MALE	 #10-32 ∅ 0.25 [6.4]	BANANA	PLUG	 ∅ 0.33 [8.3] ∅ 0.75 [19.1]
	FEMALE	 3/4-20 ∅ 0.61 [15.6]		FEMALE	 #10-32		JACK	 ∅ 0.43 [11.0] ∅ 0.16 [4.1]
BNC	MALE	 ∅ 0.57 [14.5]	REVERSE POLARITY BNC	MALE	 ∅ 0.57 [14.5]	75 OHM BNC	MALE	 ∅ 0.57 [14.5]
	FEMALE	 ∅ 0.44 [11.1]		FEMALE	 ∅ 0.44 [11.1]		FEMALE	 ∅ 0.44 [11.1]

* SMA, 2.92mm, & 3.5mm コネクタは機械的、電気的に嵌合します。

** 1.85mm & 2.4mm コネクタは機械的、電気的に嵌合します。

コネクタ識別図

仕様は、コネクタを識別する目的のみの記載です。

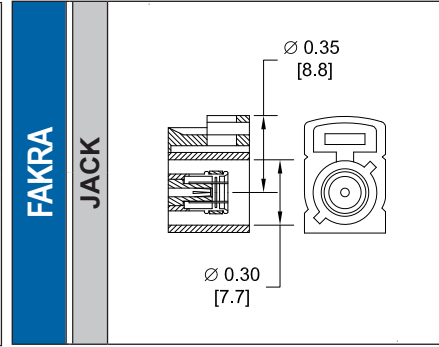
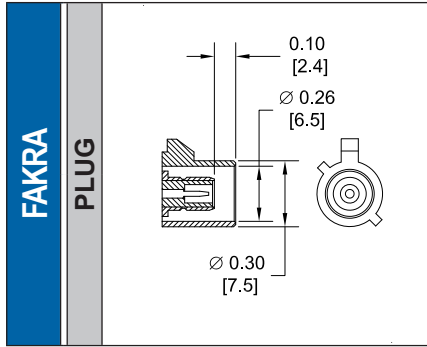
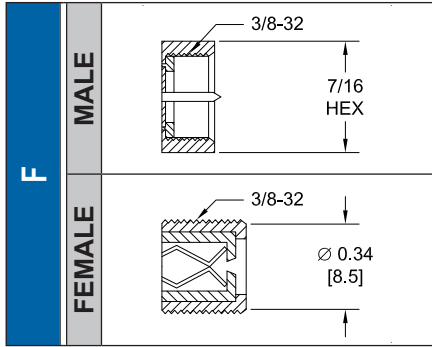
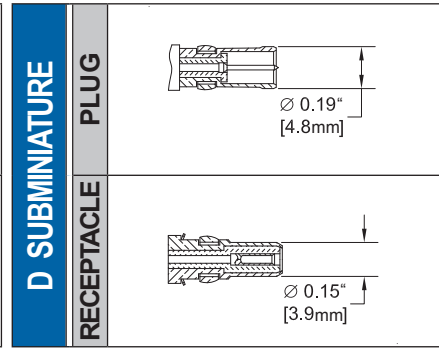
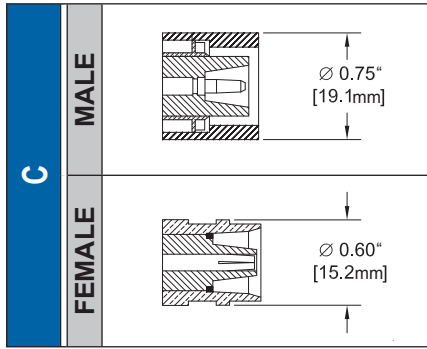
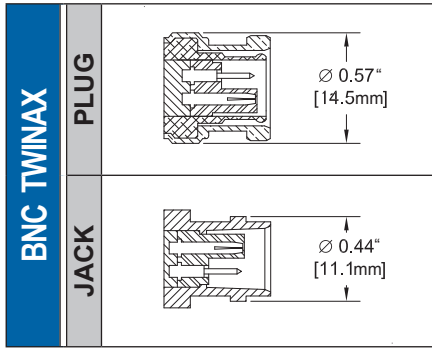

FAKRA

COMPLETE KEY CODE INFO



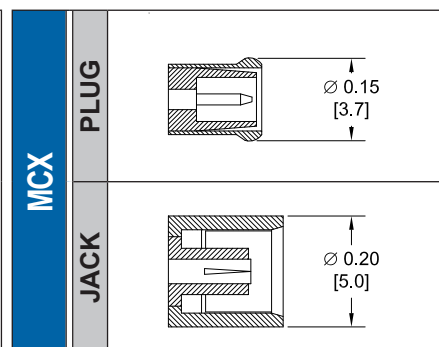
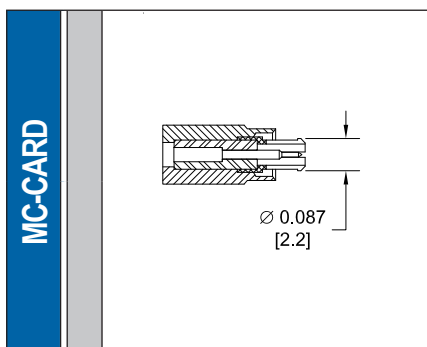
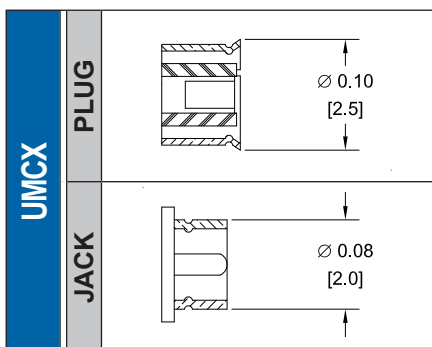
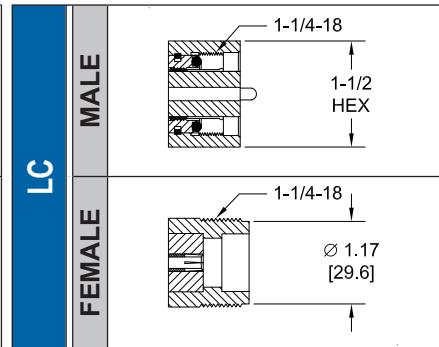
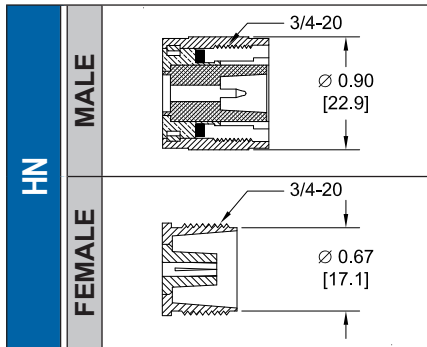
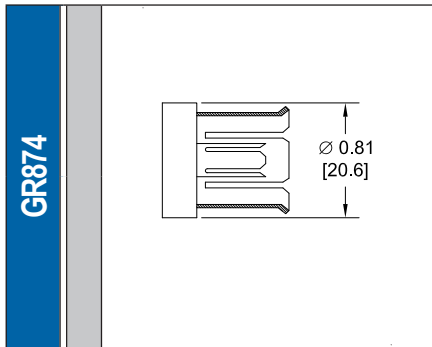
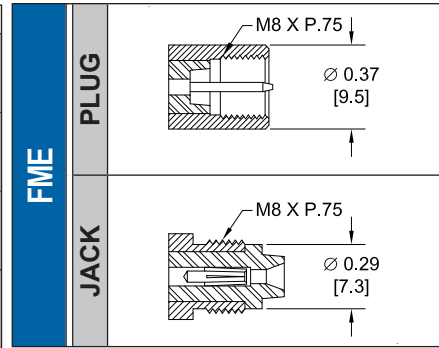

CODE	JACK	PLUG	COLOR	APPLICATION
A			BLACK	RADIO WITH PHANTOM SUPPLY
B			WHITE	RADIO WITHOUT PHANTOM SUPPLY
C			BLUE	GPS: TELEMATICS OR NAVIGATION
D			BORDEAUX	GSM: CELLULAR PHONE

CODE	JACK	PLUG	COLOR	APPLICATION
H			VIOLET	GPS: TELEMATICS AND NAVIGATION
I			BEIGE	BLUETOOTH
K			CURRY	RADIO WITH I.F. OUTPUT (ANTENNA DIVERSITY)
Z			WATER BLUE	NEUTRAL CODING

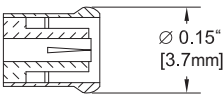
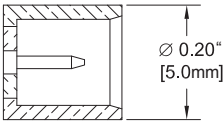
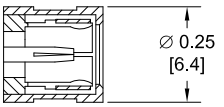
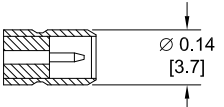
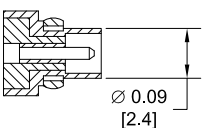
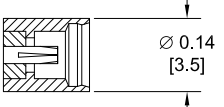
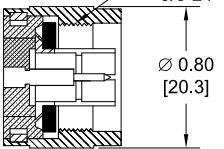
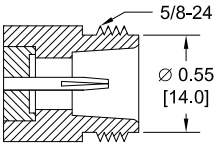
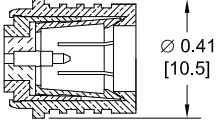
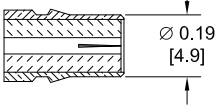
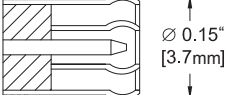
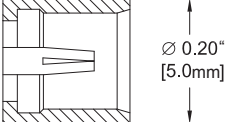
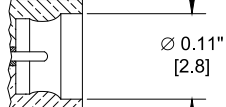
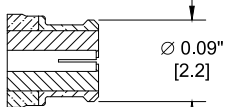
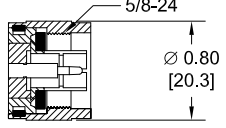
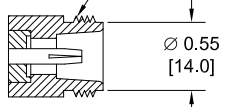
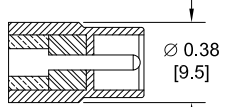
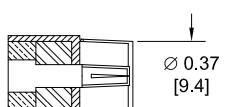
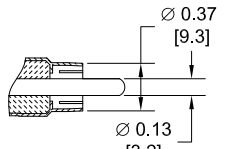
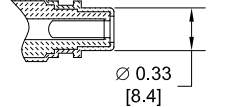

コネクタ識別図

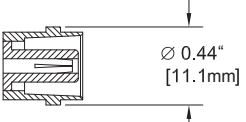
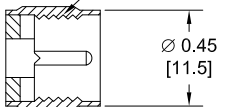
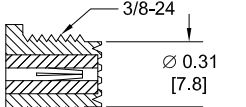
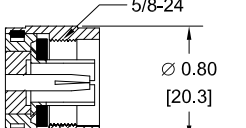
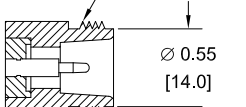
仕様は、コネクタを識別する目的のみの記載です。

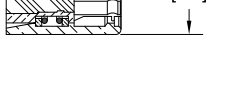
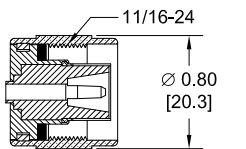
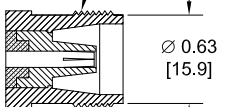
REVERSE POLARITY MCX	PLUG	 ∅ 0.15" [3.7mm]
	JACK	 ∅ 0.20" [5.0mm]
MINI 75 OHM SMB	PLUG	 ∅ 0.25 [6.4]
	JACK	 ∅ 0.14 [3.7]
MMCX	PLUG	 ∅ 0.09 [2.4]
	JACK	 ∅ 0.14 [3.5]
75 OHM N	MALE	 5/8-24 ∅ 0.80 [20.3]
	FEMALE	 5/8-24 ∅ 0.55 [14.0]
QMA	MALE	 ∅ 0.41 [10.5]
	FEMALE	 ∅ 0.19 [4.9]
75 OHM MCX	PLUG	 ∅ 0.15" [3.7mm]
	JACK	 ∅ 0.20" [5.0mm]
MINI SMP	MALE	 ∅ 0.11" [2.8]
	FEMALE	 ∅ 0.09" [2.2]
N	MALE	 5/8-24 ∅ 0.80 [20.3]
	FEMALE	 5/8-24 ∅ 0.55 [14.0]
PAL	PLUG	 ∅ 0.38 [9.5]
	JACK	 ∅ 0.37 [9.4]
RCA	PLUG	 ∅ 0.37 [9.3] ∅ 0.13 [3.2]
	JACK	 ∅ 0.33 [8.4]
MHV	MALE	 ∅ 0.57" [14.5mm]
	FEMALE	 ∅ 0.44" [11.1mm]
MINI-UHF	MALE	 3/8-24 ∅ 0.45 [11.5]
	FEMALE	 3/8-24 ∅ 0.31 [7.8]
REVERSE POLARITY N	MALE	 5/8-24 ∅ 0.80 [20.3]
	FEMALE	 5/8-24 ∅ 0.55 [14.0]
POSITIVE SNAP	MALE	 ∅ 0.39 [9.9]
	FEMALE	
SC	MALE	 11/16-24 ∅ 0.80 [20.3]
	FEMALE	 11/16-24 ∅ 0.63 [15.9]

コネクタ識別図

仕様は、コネクタを識別する目的のみの記載です。

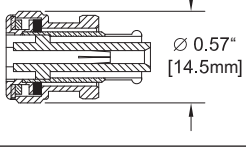
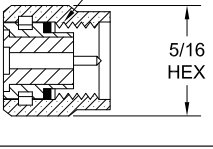
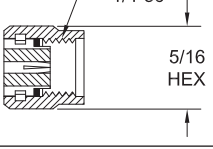
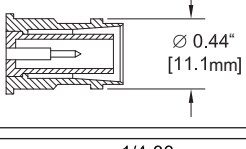
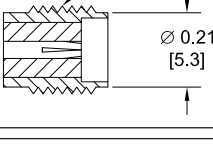
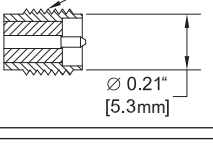
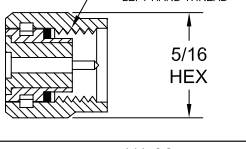
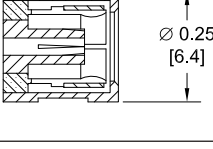
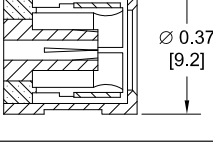
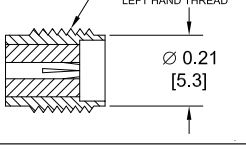
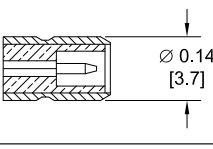
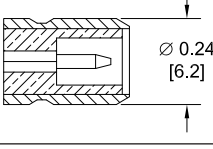
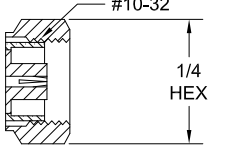
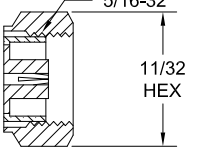
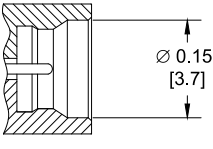
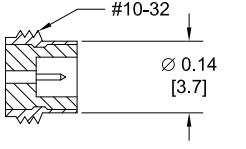
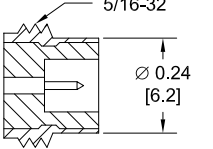
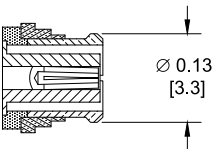
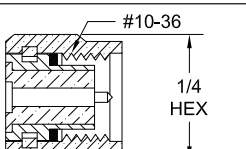
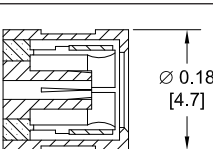
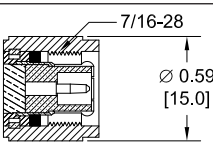
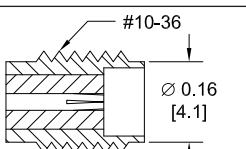
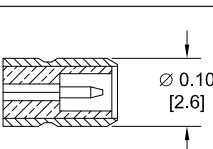
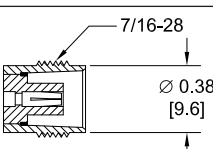
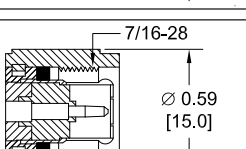
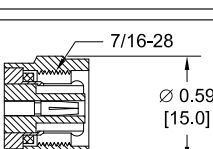
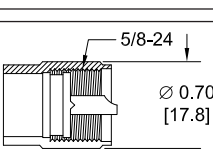
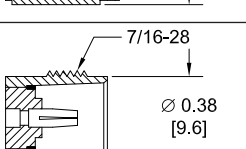
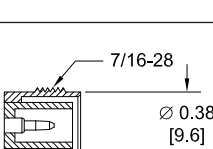
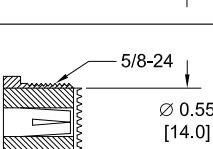
SHV	PLUG	 Ø 0.57" [14.5mm]	SMA*	MALE	 1/4-36 5/16 HEX	REVERSE POLARITY SMA	MALE	 1/4-36 5/16 HEX
	JACK	 Ø 0.44" [11.1mm]		FEMALE	 1/4-36 Ø 0.21 [5.3]		FEMALE	 1/4-36 Ø 0.21" [5.3mm]
SMA REVERSE THREAD	MALE	 1/4-36 LEFT HAND THREAD 5/16 HEX	SMB	PLUG	 Ø 0.25 [6.4]	75 OHM SMB	PLUG	 Ø 0.37 [9.2]
	FEMALE	 1/4-36 LEFT HAND THREAD Ø 0.21 [5.3]		JACK	 Ø 0.14 [3.7]		JACK	 Ø 0.24 [6.2]
SMC	PLUG	 #10-32 1/4 HEX	75 OHM SMC	PLUG	 5/16-32 11/32 HEX	SMP	MALE	 Ø 0.15" [3.7]
	JACK	 #10-32 Ø 0.14 [3.7]		JACK	 5/16-32 Ø 0.24 [6.2]		FEMALE	 Ø 0.13" [3.3]
SSMA	MALE	 #10-36 1/4 HEX	SSMB	PLUG	 Ø 0.18 [4.7]	TNC	MALE	 7/16-28 Ø 0.59 [15.0]
	FEMALE	 #10-36 Ø 0.16 [4.1]		JACK	 Ø 0.10 [2.6]		FEMALE	 7/16-28 Ø 0.38 [9.6]
75 OHM TNC	MALE	 7/16-28 Ø 0.59 [15.0]	REVERSE POLARITY TNC	MALE	 7/16-28 Ø 0.59 [15.0]	UHF	MALE	 5/8-24 Ø 0.70 [17.8]
	FEMALE	 7/16-28 Ø 0.38 [9.6]		FEMALE	 7/16-28 Ø 0.38 [9.6]		FEMALE	 5/8-24 Ø 0.55 [14.0]

* SMA, 2.92mm & 3.5mm コネクタは機械的、電氣的に嵌合します。